



FIXED DISPLACEMENT HYDRAULIC VANE PUMPS "BV" SERIES

Versatility, power, compactness and low running costs are the main characteristics of B&C vane pumps. All the components subject to wear are contained in a cartridge unit that can be easily removed for inspection and/or replacement without disconnecting the pump from the circuit, drastically reducing expensive machine down time.

The cartridge contains a rotor, vanes and inserts, a cam ring and two covers. During operation the rotor is driven by a splined shaft coupled to the drive unit. As the rotation speed increases, centrifugal forces, in combination with the pressure generated behind the vanes, push the vanes outwards, where they follow the profile of the cam of the ring with a sufficient contact pressure to ensure adequate hydraulic sealing. The two opposed pumping chambers formed by the elliptical profile of the cam cancel out radial loads on the shaft bearings, thereby giving them extremely long lifetimes.

The versatility of the BV series pumps enables them to meet the requirements of the most varied industrial applications. In fact, as well as their proven high reliability and excellent volumetric efficiency in all working conditions, they operate with particularly low noise levels. This is made possible by the special profile of the cam ring and the use of a 12 vane rotor that reduces the amplitude of the supply pressure pulses, thereby reducing induced vibrations (see drawing).

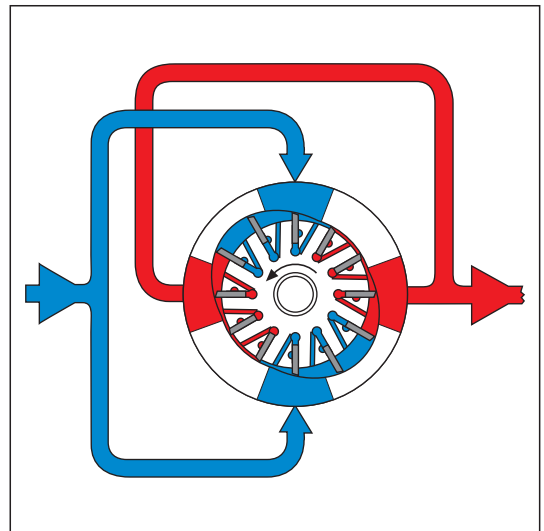

The BV series is available in four versions of single pump (from 8 to 230 l/min at 1200 rpm) and six versions of double pump (from 55 to 370 l/min at 1200 rpm), with maximum powers of over 300 HP. The BV series pumps are extremely compact and are supplied with ISO norm mechanical couplings and SAE norm hydraulic fittings. This makes them very easy to install and guarantees their interchangeability with other similar pumps.

contents

Single pumps BV01..... pag. 3

Single pumps BV02..... pag. 11

Single pumps BV04..... pag. 18

Single pumps BV05..... pag. 25

Double pumps BV21..... pag. 32

Double pumps BV41..... pag. 42

Double pumps BV42..... pag. 52

Double pumps BV51..... pag. 61

Double pumps BV52..... pag. 71

Double pumps BV54..... pag. 80

Id. codes of cartridge kit components..... pag. 89

Operating instructions..... pag. 91

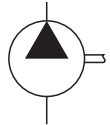
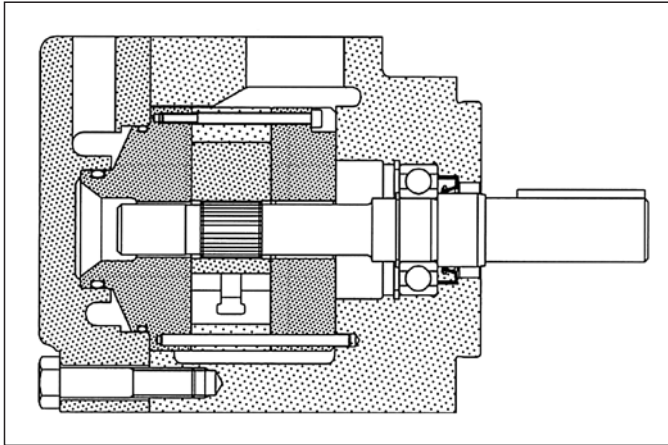

General description

Fixed displacement vane pump, hydraulically balanced, with capacity determined by the type of cartridge used and the speed of rotation. The pump is available in six versions with capacities from 8 to 55 l/min (*from 2 to 14 gpm*) at 1200 rpm and 7 bar.

Technical characteristics

Cartridge model	Geometric displacement		Rated capacity at 1200 rpm 7 bar		Rated capacity at 1500 rpm 7 bar		Maximum pressure with mineral oil		Speed range rpm	
	cm ³ /g	(in ³ /r)	l/min	(gpm)	l/min	(gpm)	bar	(psi)	min	max
V01-02	7,2	(0.44)	8,3	(2)	10,4	(2.8)	210	(3050)	600	1800
V01-05	18,0	(1.10)	20,8	(5)	26,1	(6.9)	210	(3050)	600	1800
V01-08	27,4	(1.67)	31,8	(8)	39,4	(10.4)	210	(3050)	600	1800
V01-09	30,1	(1.83)	35,1	(9)	44,1	(11.7)	210	(3050)	600	1800
V01-11	36,4	(2.22)	42,4	(11)	52,6	(13.9)	210	(3050)	600	1800
V01-12	39,5	(2.41)	46,9	(12)	58,7	(15.5)	160	(2300)	600	1800
V01-14	45,9	(2.79)	54,9	(14)	69,6	(18.4)	140	(2030)	600	1800

Hydraulic fluids: antiwear high quality mineral oils or fire resistant fluid having same lubrication capacities of the mineral oil.

Viscosity range (*with mineral oil*): from 13 to 860 cSt. (*13 to 54 cSt. recommended*).

Filtration: for the inlet - 149 micron abs., for the return line - 25 micron abs. or better (*with synthetic fluids: for the return line - 10 micron abs. or better*).

Inlet pressure: (*with mineral oil*): from -0,17 to +1,4 bar (-2.5 to + 20 psi)

Operating temperature: with mineral oil -10°C +70°C (*+30°C to +60°C recommended*), with water based fluids +15°C to +50°C.

Drive: direct and coaxial by means of a flexible coupling.

Main operating data

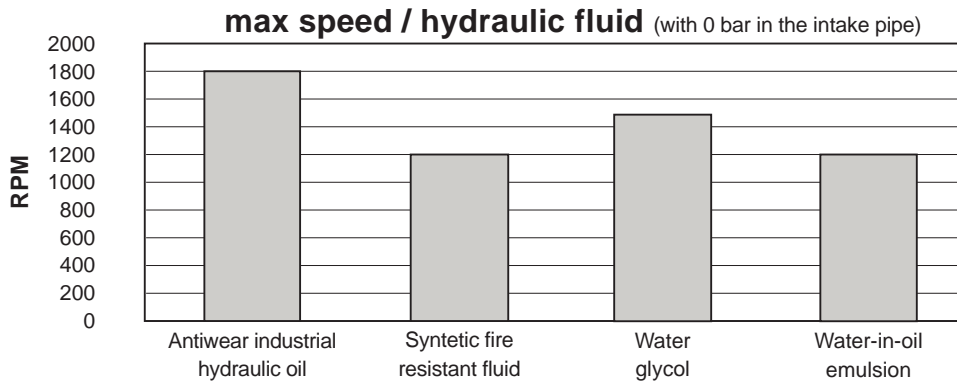
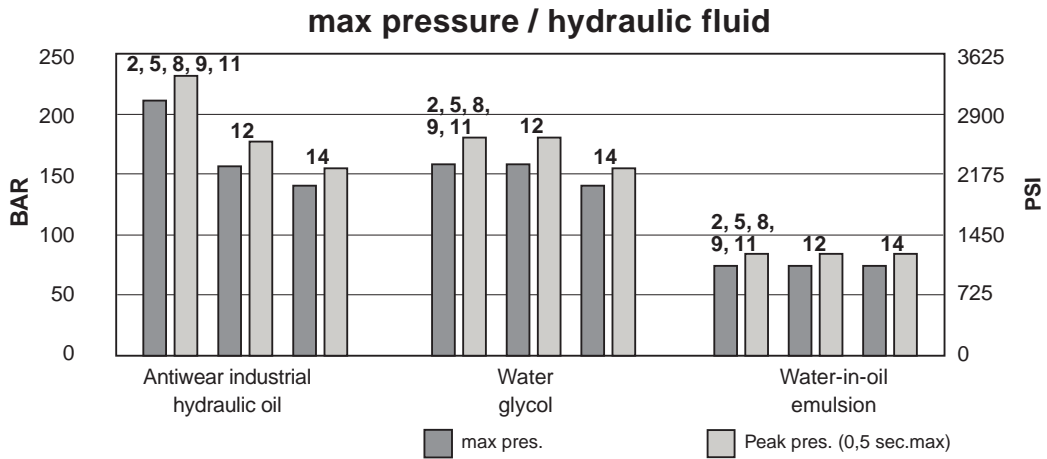

If the intake pressure is not zero bar, use the graph below to find the percentage correction factor to apply to the maximum speed

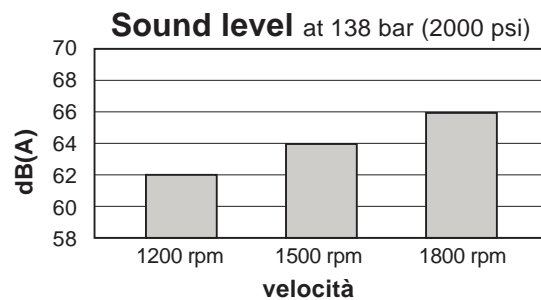
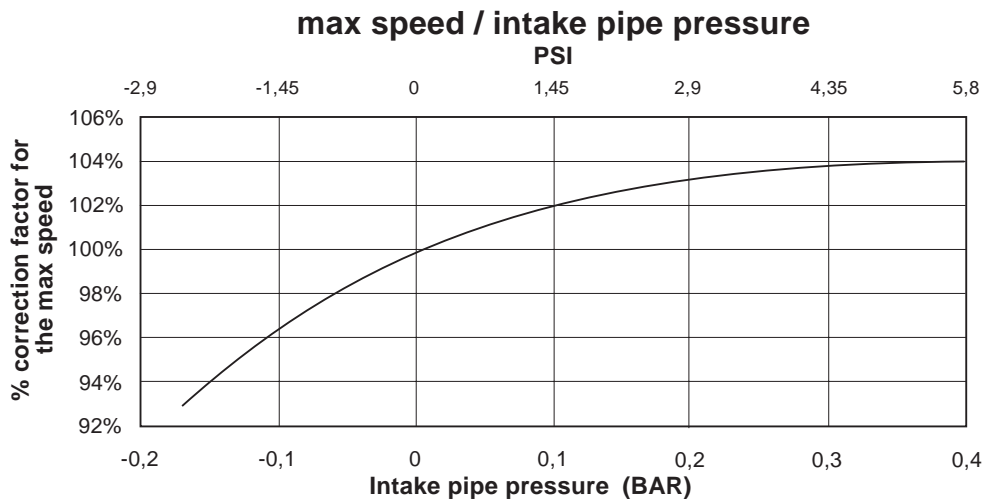

Cartridge V01-02

flow / pressure

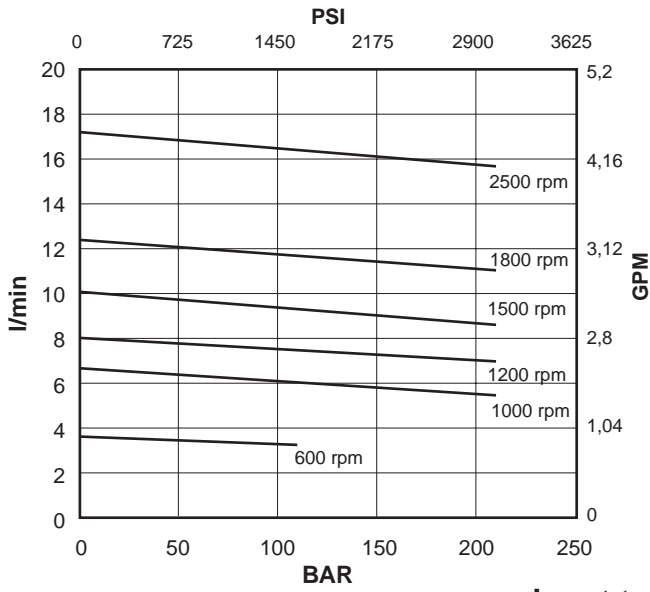

power / pressure

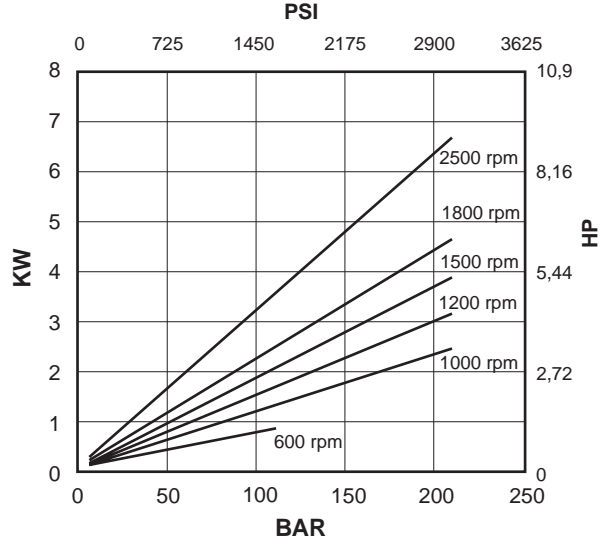

input torque / pressure

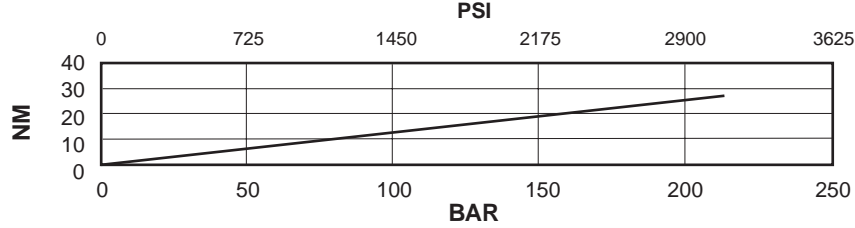

Oil viscosity: 25 c.St.(10W)
Temperature: 45°C
Inlet pressure: 0 BAR

Cartridge V01-05

flow / pressure

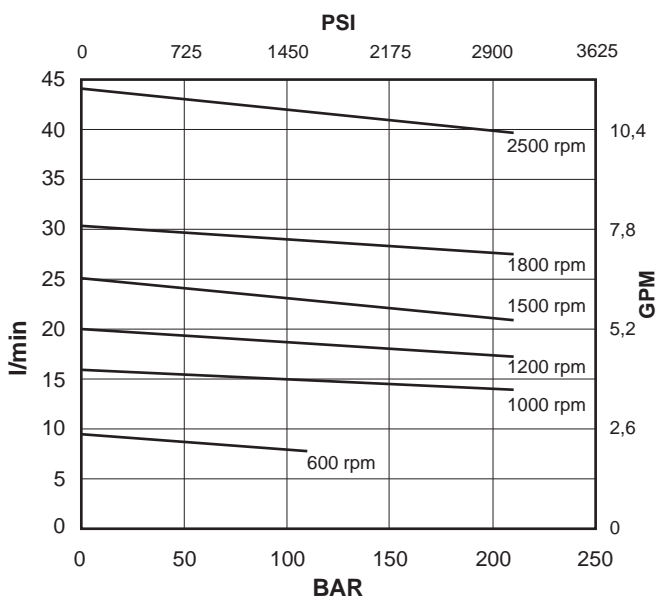

power / pressure

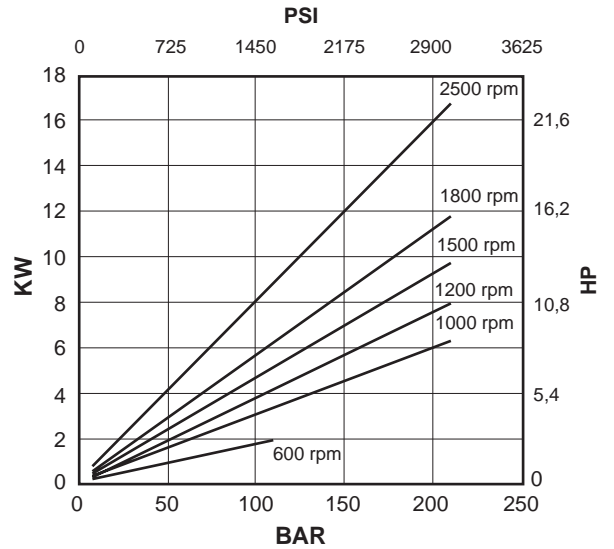

input torque / pressure

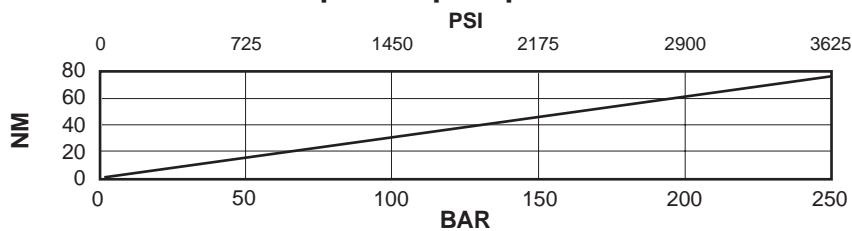

Oil viscosity: 25 c.St.(10W)
Temperature: 45°C
Inlet pressure: 0 BAR

Cartridge V01-08

flow / pressure

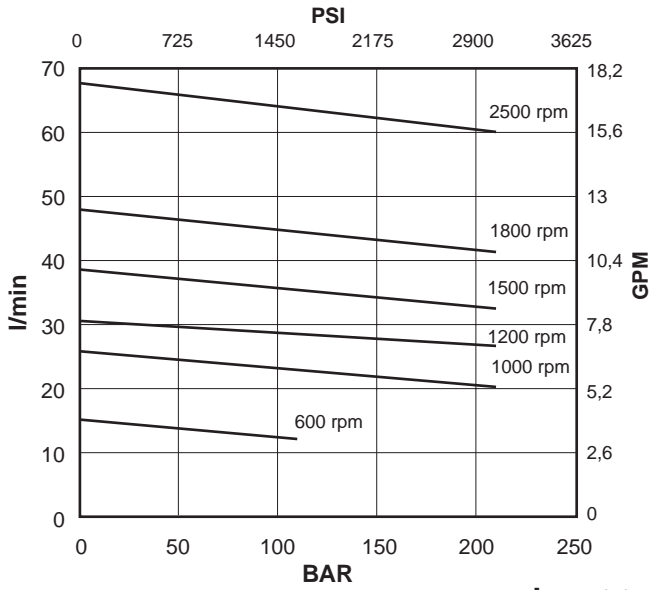

power / pressure

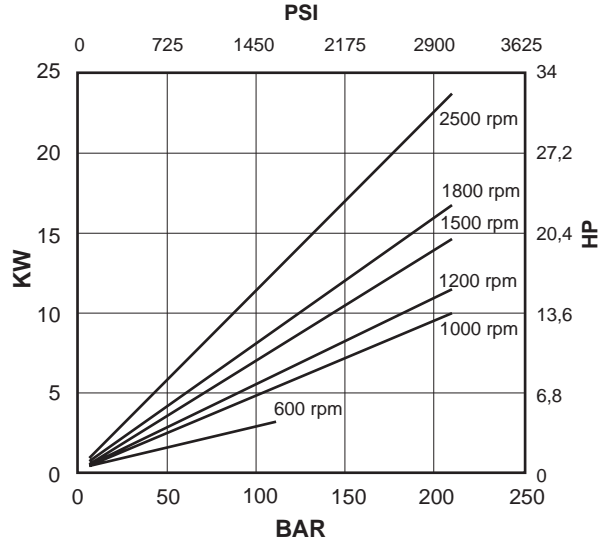

input torque / pressure

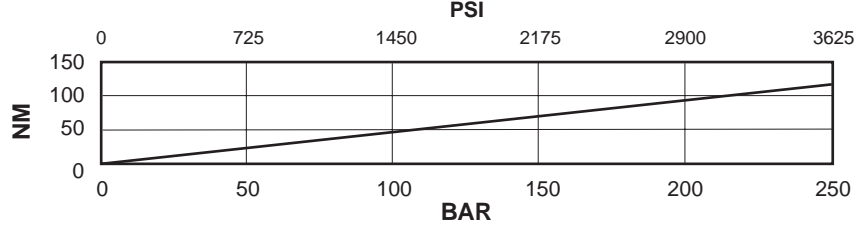

Oil viscosity: 25 c.St.(10W)
Temperature: 45°C
Inlet pressure: 0 BAR

Cartridge V01-09

flow / pressure

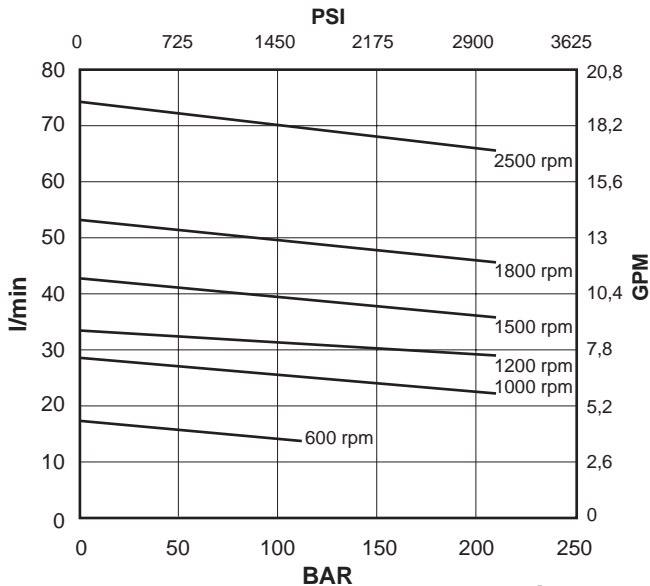

power / pressure

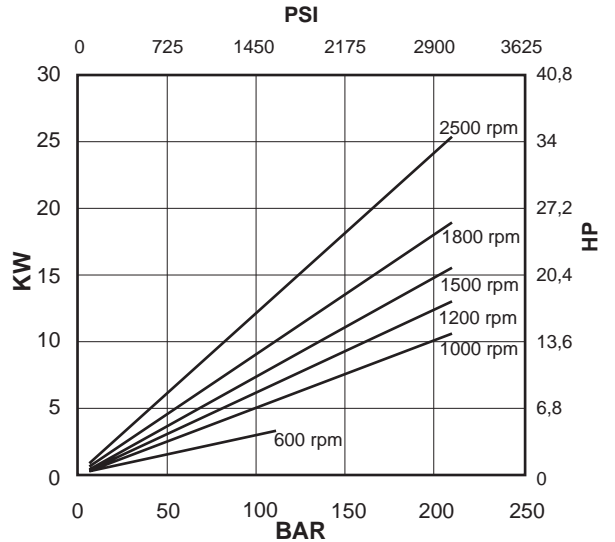

input torque / pressure

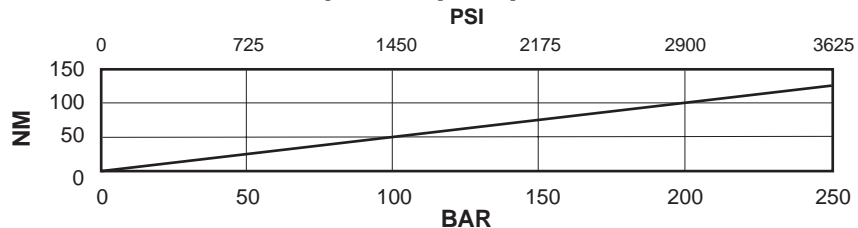

Oil viscosity: 25 c.St.(10W)
Temperature: 45°C
Inlet pressure: 0 BAR

Cartridge V01-11

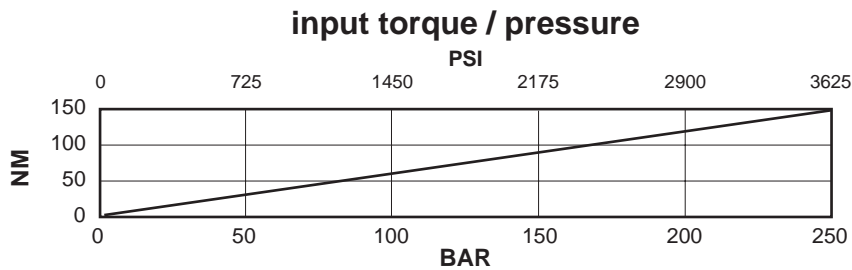
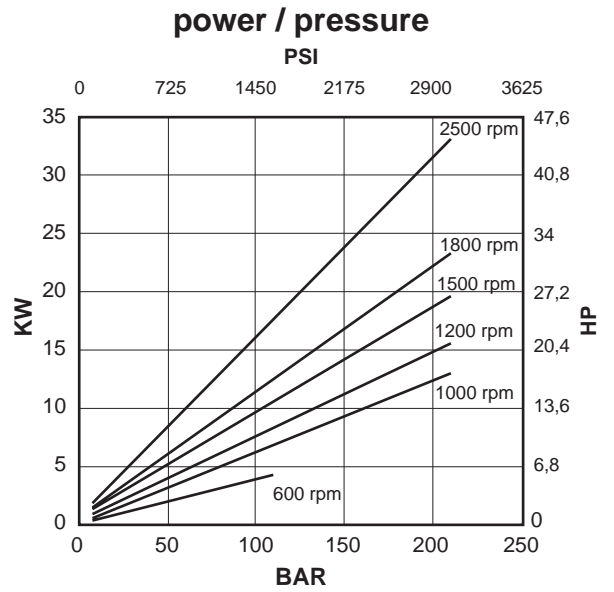
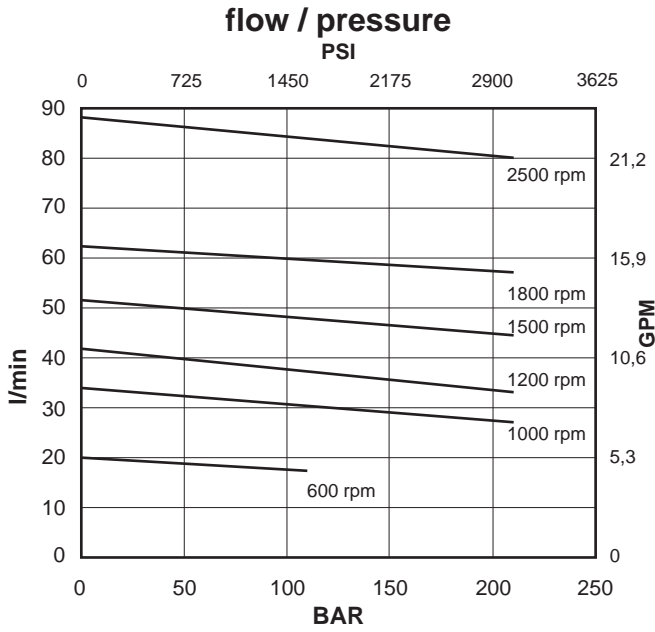

Oil viscosity: 25 c.St.(10W)
 Temperature: 45°C
 Inlet pressure: 0 BAR

Cartridge V01-12

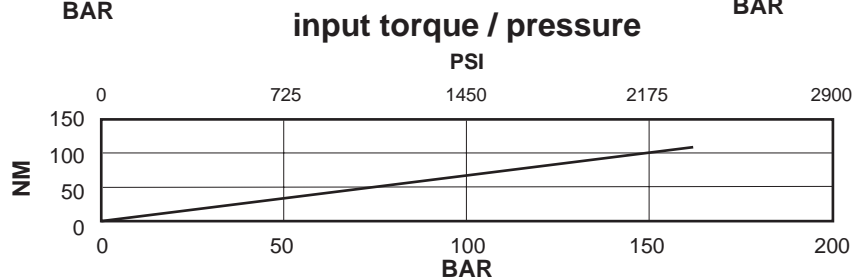
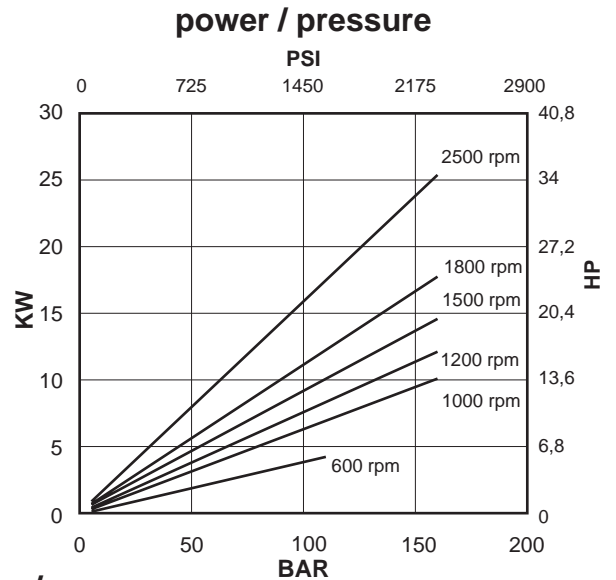
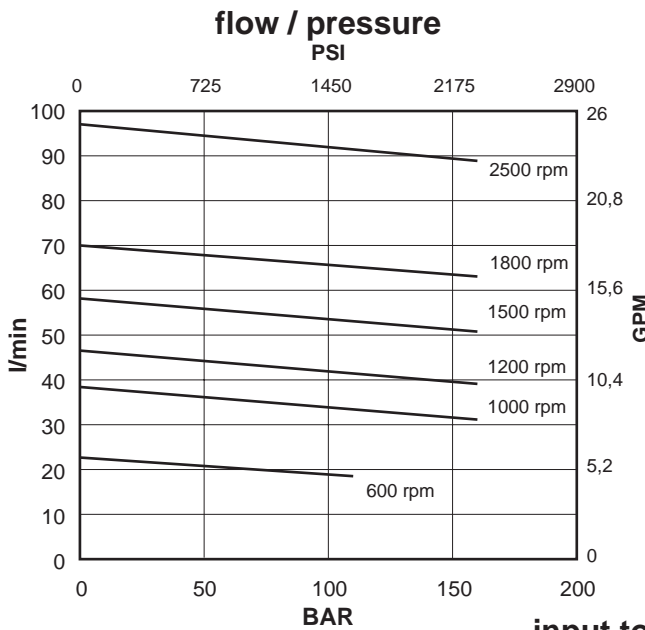

Oil viscosity: 25 c.St.(10W)
 Temperature: 45°C
 Inlet pressure: 0 BAR

Cartridge V01-14

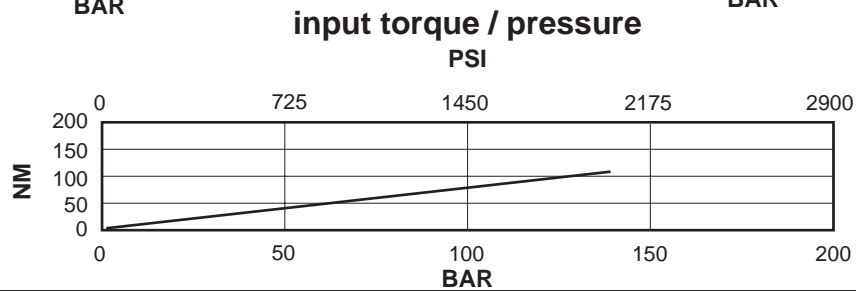
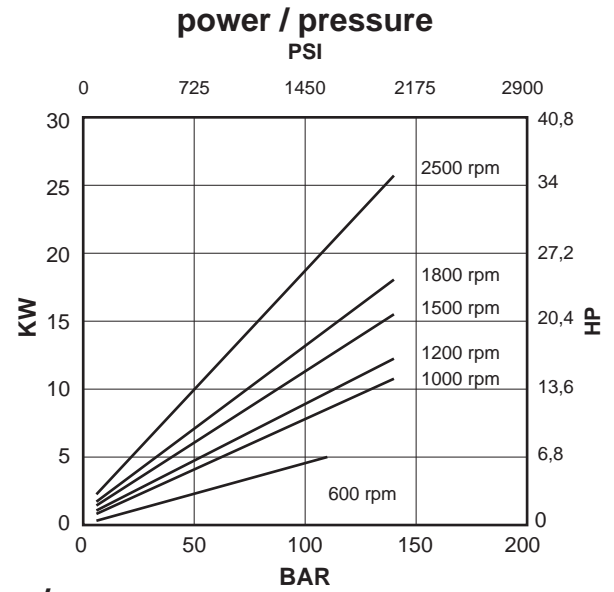
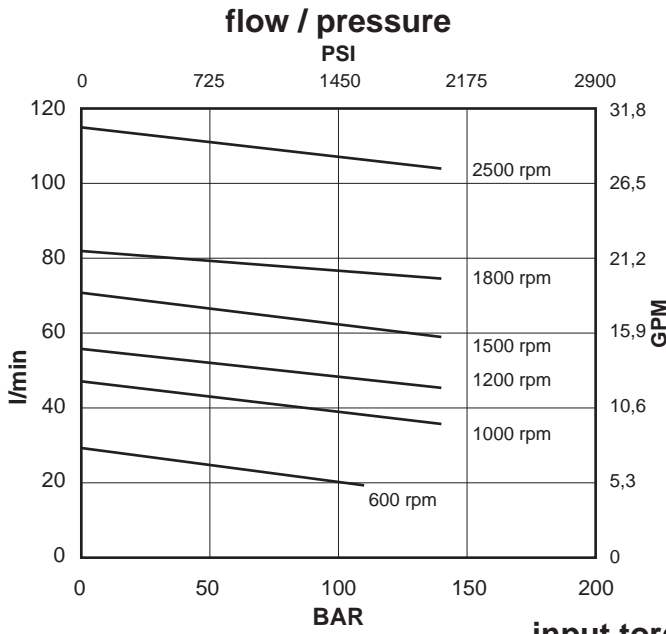

Oil viscosity: 25 c.St.(10W)
 Temperature: 45°C
 Inlet pressure: 0 BAR

Installation dimensions mm (inches)

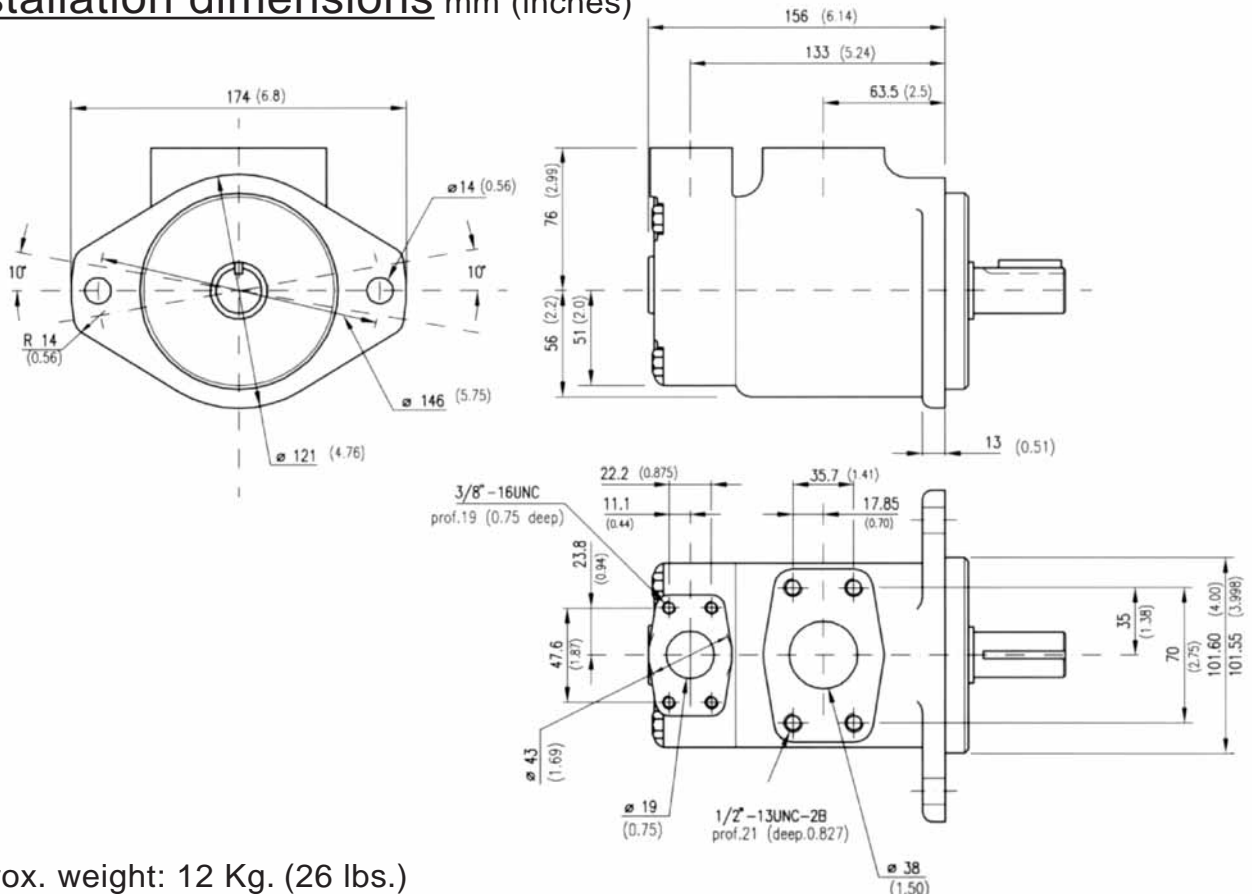

Approx. weight: 12 Kg. (26 lbs.)

Model code breakdown

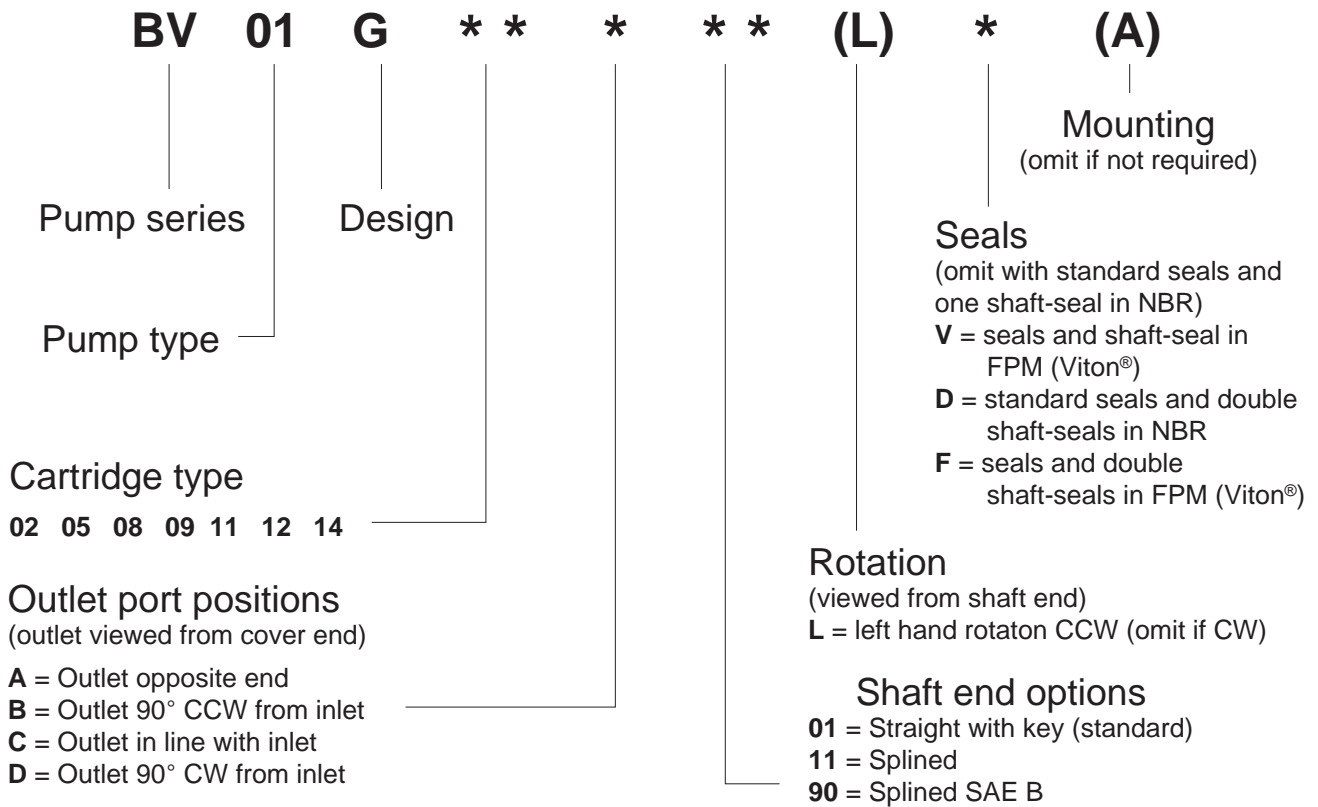

Shaft options mm (inches)

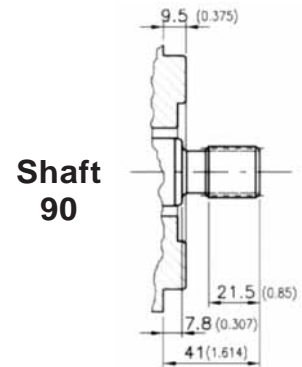
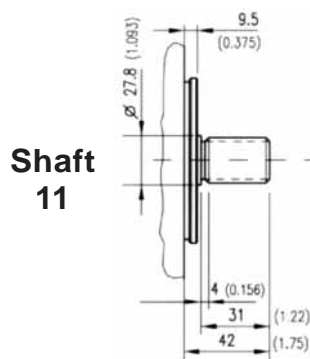
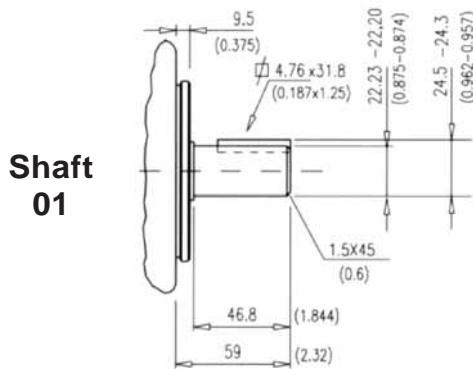

PORT ORIENTATIONS

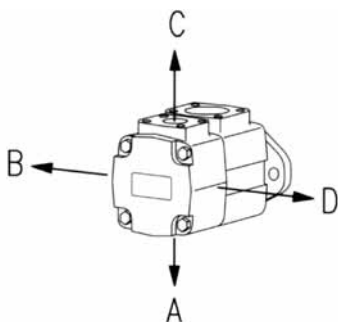

Spline data

(shaft 11 and shaft 90)

Involute side fit (ASA B5.15)

Spline	Involute side fit (ASA B5.15)	
Pressure angle	30°	
No. of teeth	13	
Pitch	16/32	
Major dia.	22.00 - 21.90	(0.866 - 0.862)
Pitch dia.	20.638	(0.8125)
Minor dia.	18.63 - 18.35	(0.733 - 0.722)
Wildhaber	11.67 - 11.70	(0.459 - 0.461)

Id. codes of pump components

Cartridge			
Series	Model	Part No.	Pump rotat.
V01	02	V0102002	right hand
	05	V0105015	
	08	V0108035	
	09	V0109055	
	11	V0111075	
	12	V0112095	
V01	14	V0114115	left hand
	02	V0102007	
	05	V0105025	
	08	V0108045	
	09	V0109065	
	11	V0111085	
12	V0112105		
14	V0114125		

Shaft kit	
Model	Part No.
01	M8010601
11	M8010611
90	M8010690

Shaft		Key	
Model	Part No.	Part No.	Part No.
01	K0101000	M8010100	-
11	K0111000	-	-
90	K0190000	-	-

Body	
Part No.	M8010010

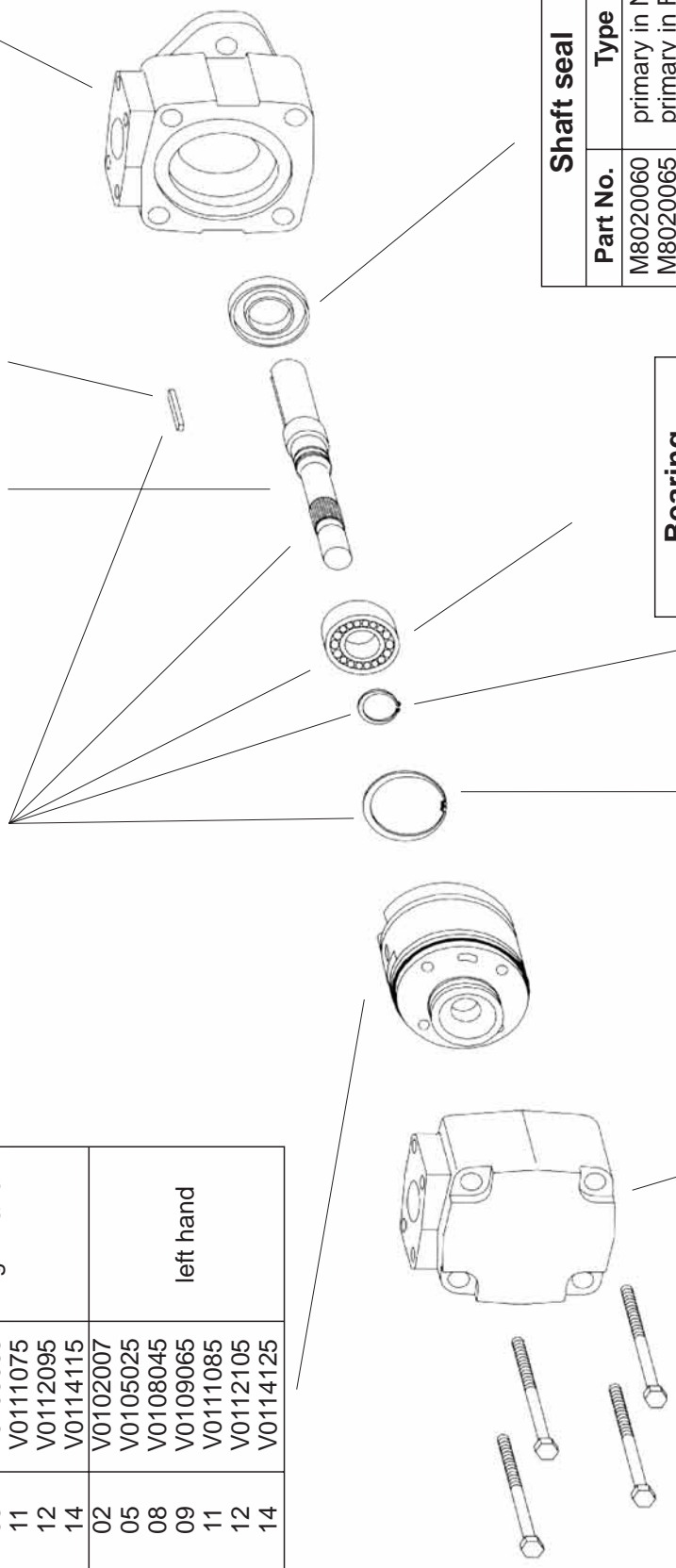

Shaft seal	
Part No.	Type
M8020060	primary in NBR
M8020065	primary in FPM
M8020061	secondary in NBR
M8020066	secondary in FPM

Bearing	
Part No.	M8010030

Seeger	
Part No.	M8010050

Seeger	
Part No.	M8010040

Cover	
Part No.	M8020120

Screw	
Part No.	M8020420
Torque to 70 Nm (625 lb. in.)	

Pump seal kit		
Part No.	Parts	Type
M8010500	seals + 1 shaft seal	NBR
M8010501	seals + 2 shaft seals	NBR
M8010503	seals + 1 shaft seal	FPM (Viton®)
M8010504	seals + 2 shaft seals	FPM (Viton®)

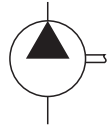
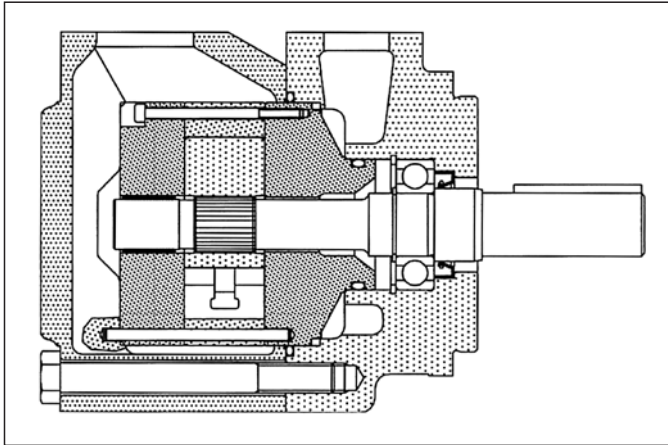

General description

Fixed displacement vane pump, hydraulically balanced, with capacity determined by the type of cartridge used and the speed of rotation. The pump is available in five versions with capacities from 47 to 79 l/min (*from 12 to 21 gpm*) at 1200 rpm and 7 bar.

Technical characteristics

Cartridge model	Geometric displacement		Rated capacity at 1200 rpm 7 bar		Rated capacity at 1500 rpm 7 bar		Maximum pressure with mineral oil		Speed range rpm	
	cm ³ /g	(in ³ /r)	l/min	(gpm)	l/min	(gpm)	bar	(psi)	min	max
V02-12	40,1	(2.45)	46,9	(12)	58,8	(15.5)	175	(2538)	600	1800
V02-14	45,4	(2.77)	52,7	(14)	65,7	(17.4)	175	(2538)	600	1800
V02-17	55,2	(3.37)	64,2	(17)	80,2	(21.2)	175	(2538)	600	1800
V02-19	60,0	(3.66)	71,0	(19)	88,7	(23.4)	175	(2538)	600	1800
V02-21	67,5	(4.12)	79,0	(21)	99,8	(26.4)	175	(2538)	600	1800

Hydraulic fluids: antiwear high quality mineral oils or fire resistant fluid having same lubrication capacities of the mineral oil.

Viscosity range (*with mineral oil*): from 13 to 860 cSt. (*13 to 54 cSt. recommended*).

Filtration: for the inlet - 149 micron abs., for the return line - 25 micron abs. or better (*with synthetic fluids: for the return line - 10 micron abs. or better*).

Inlet pressure: (*with mineral oil*): from -0,17 to +1,4 bar (*-2.5 to + 20 psi*)

Operating temperature: with mineral oil -10°C +70°C (*+30° C to +60° C recommended*), with water based fluids +15°C to +50°C.

Drive: direct and coaxial by means of a flexible coupling.

Main operating data

max pressure / hydraulic fluid

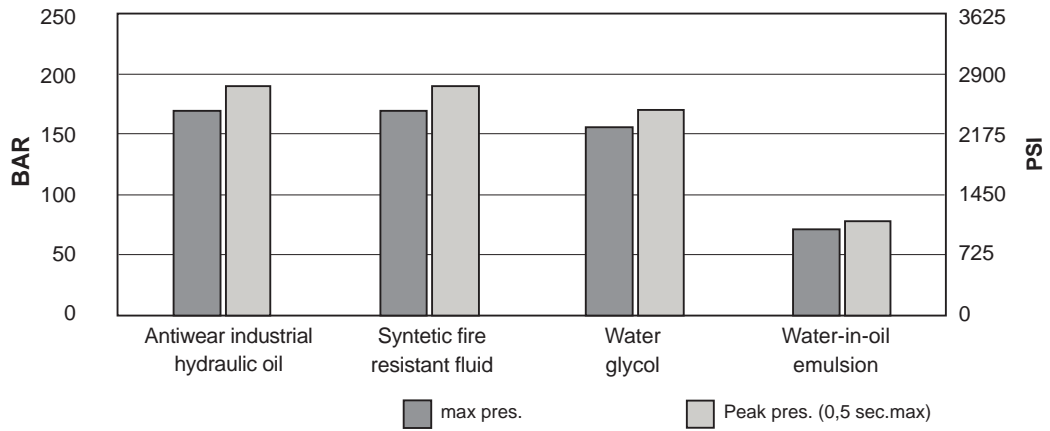

max speed / hydraulic fluid (with 0 bar in the intake pipe)

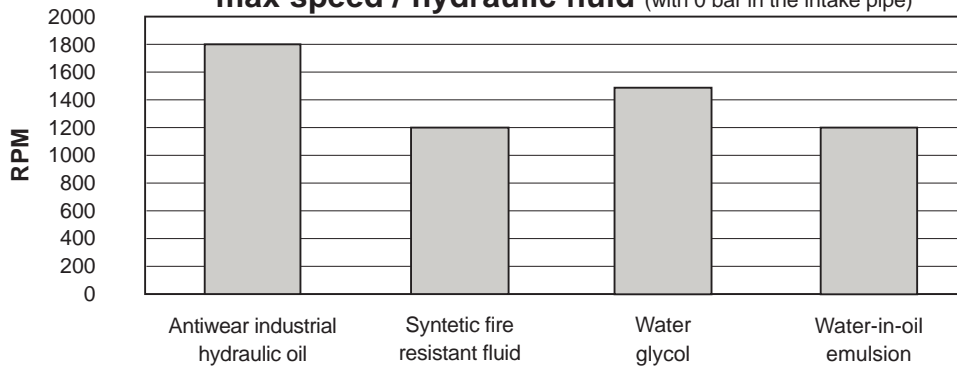

If the intake pressure is not zero bar, use the graph below to find the percentage correction factor to apply to the maximum speed

max speed / intake pipe pressure

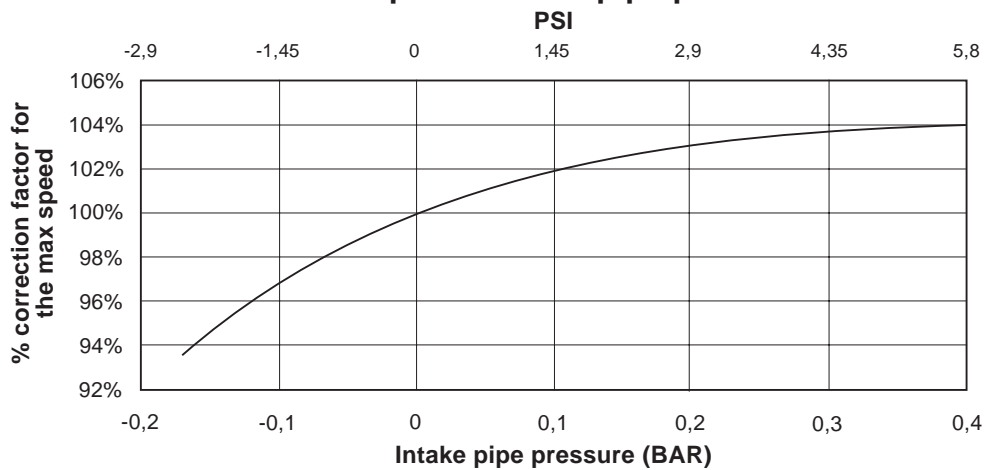

Sound level at 138 bar (2000 psi)

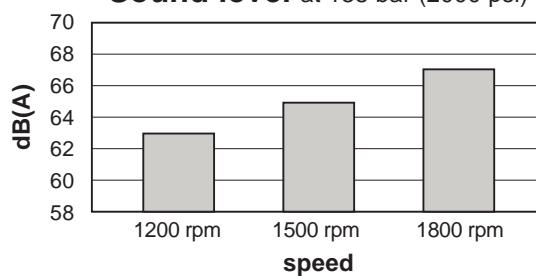

Cartridge V02-12

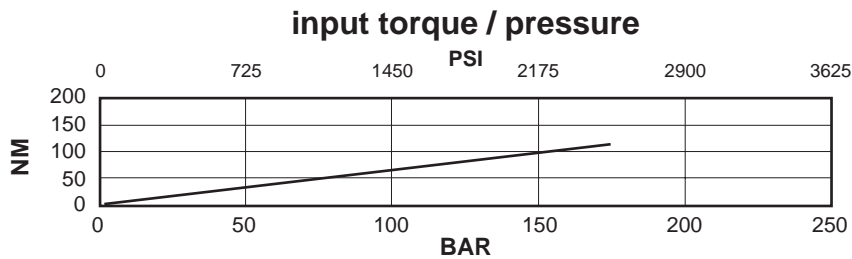
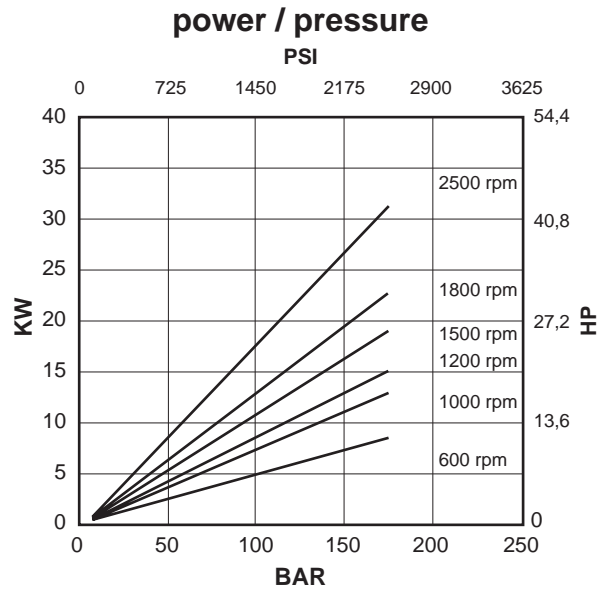
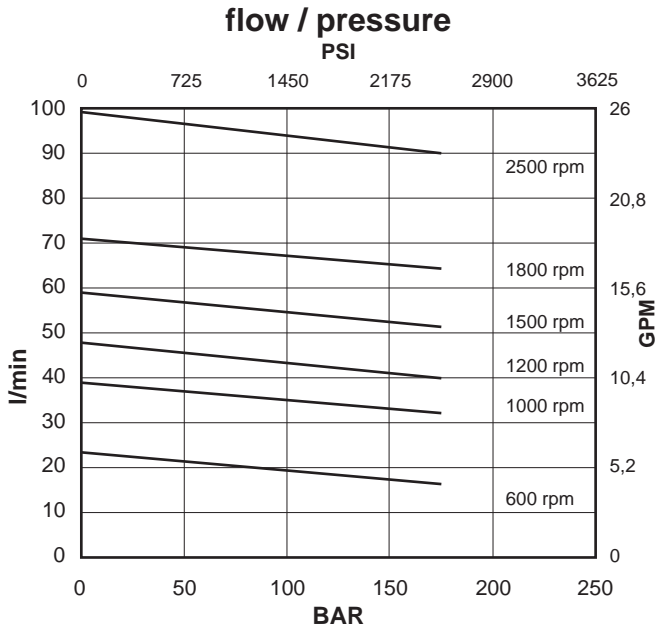

Oil viscosity: 25 c.St.(10W)
 Temperature: 45°C
 Inlet pressure: 0 BAR

Cartridge V02-14

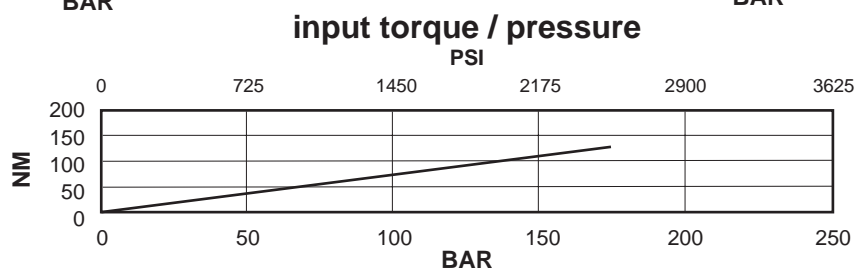
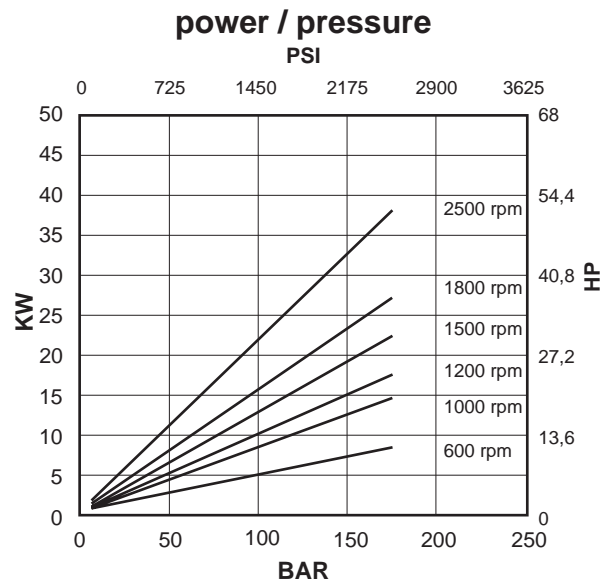
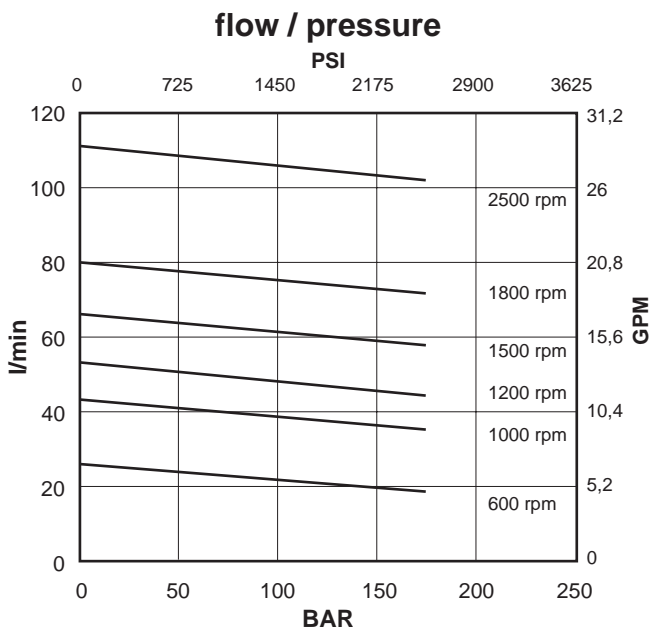

Oil viscosity: 25 c.St.(10W)
 Temperature: 45°C
 Inlet pressure: 0 BAR

Cartridge V02-17

flow / pressure

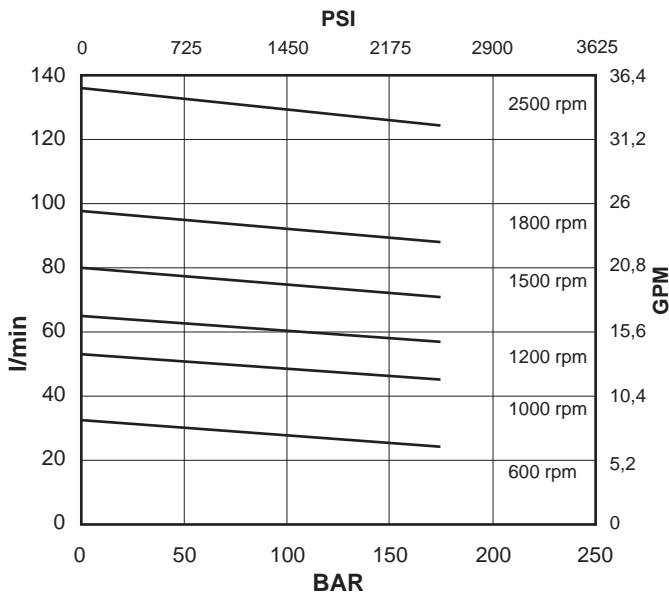

power / pressure

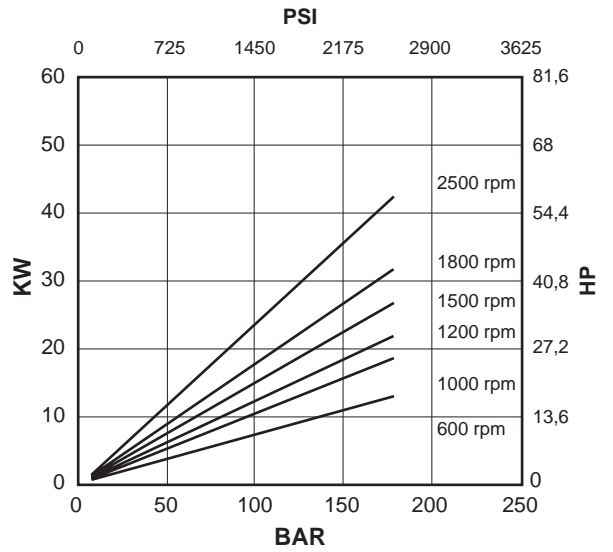

input torque / pressure

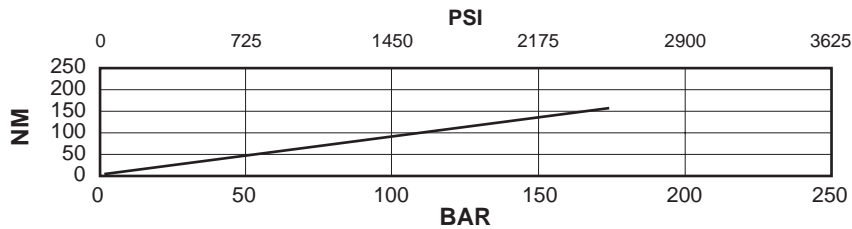

Oil viscosity: 25 c.St.(10W)
Temperature: 45°C
Inlet pressure: 0 BAR

Cartridge V02-19

flow / pressure

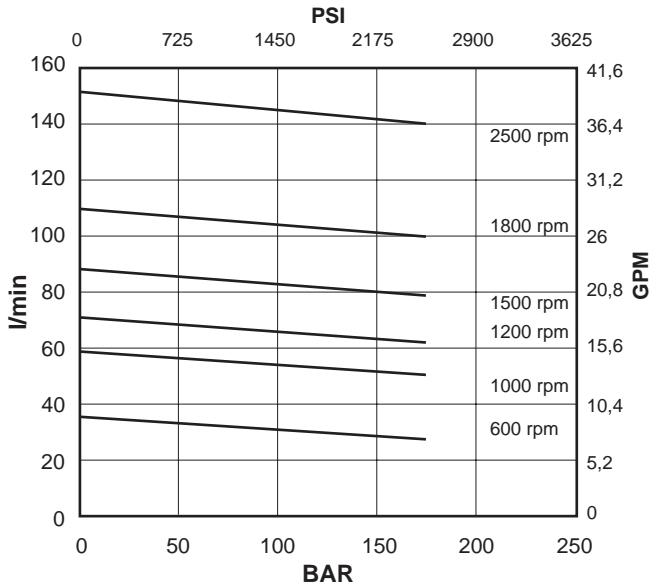

power / pressure

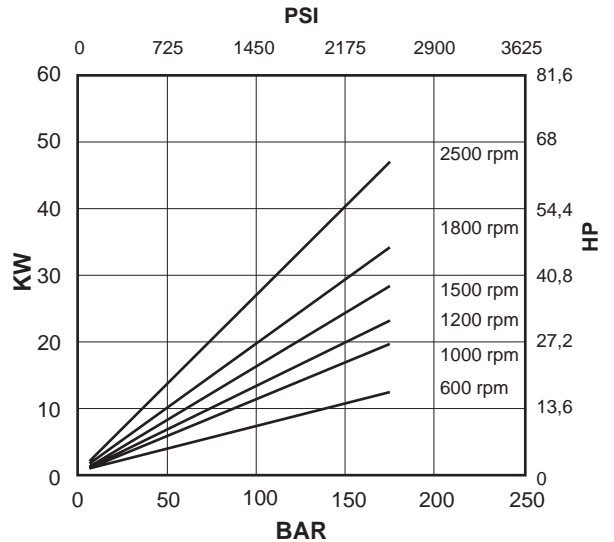

input torque / pressure

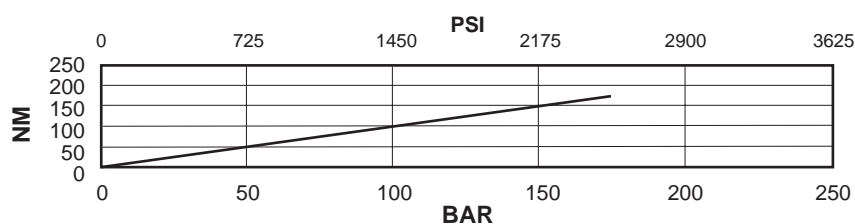

Oil viscosity: 25 c.St.(10W)
Temperature: 45°C
Inlet pressure: 0 BAR

Cartridge V02-21

flow / pressure

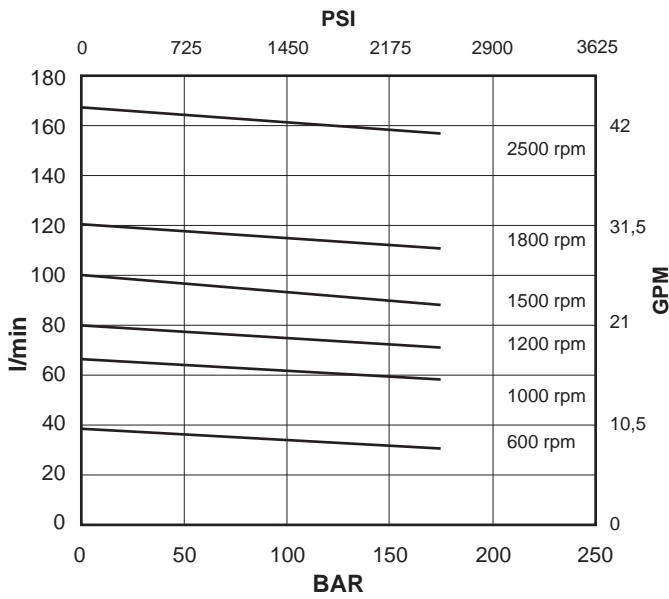

power / pressure

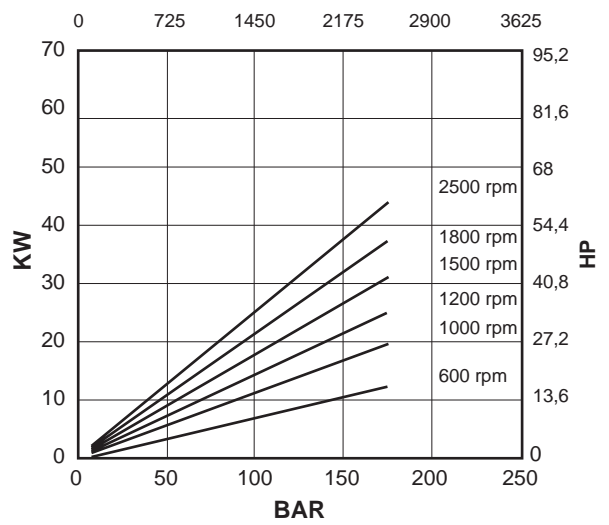

input torque / pressure

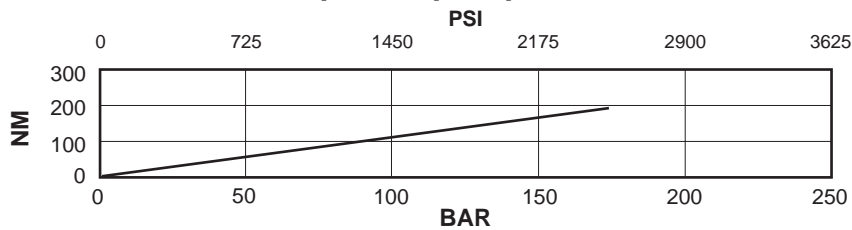

Oil viscosity: 25 c.St.(10W)
 Temperature: 45°C
 Inlet pressure: 0 BAR

Installation dimensions mm (inches)

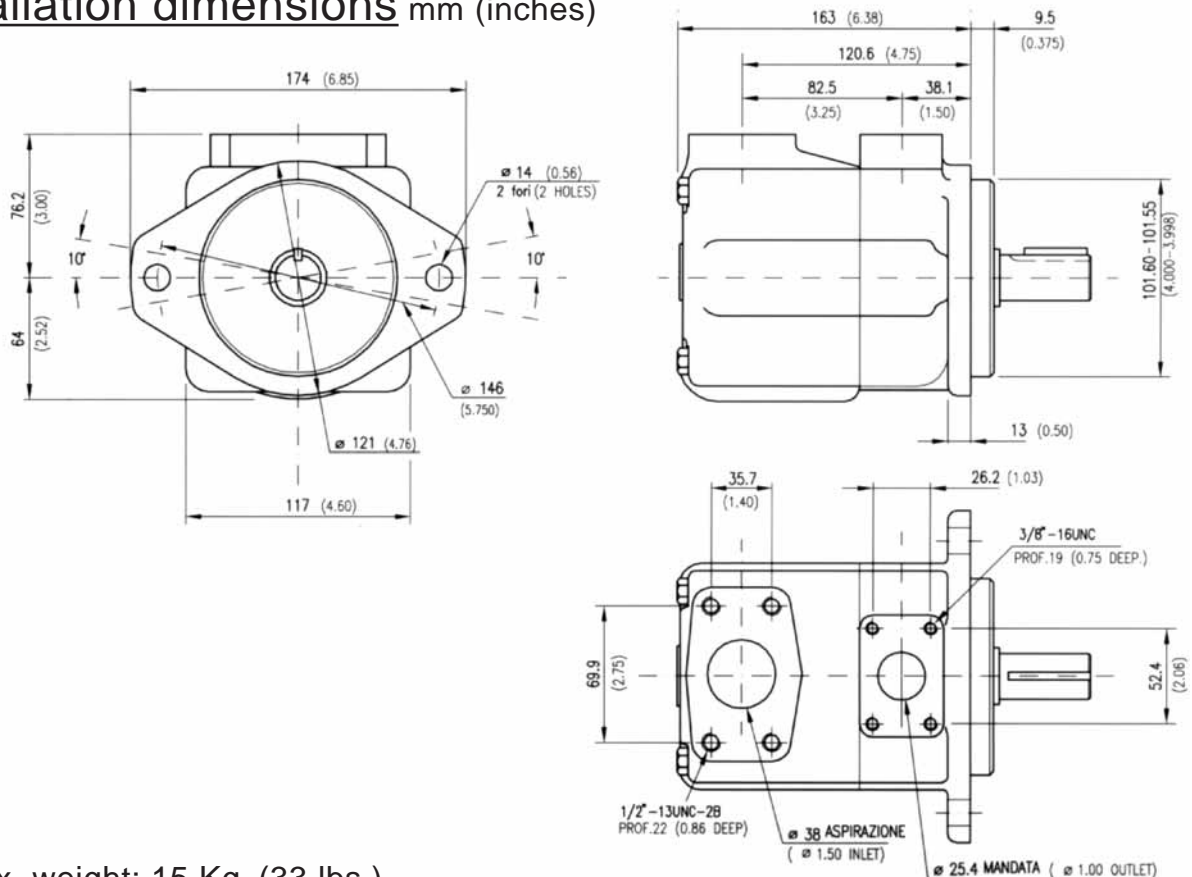

Approx. weight: 15 Kg. (33 lbs.)

Model code breakdown

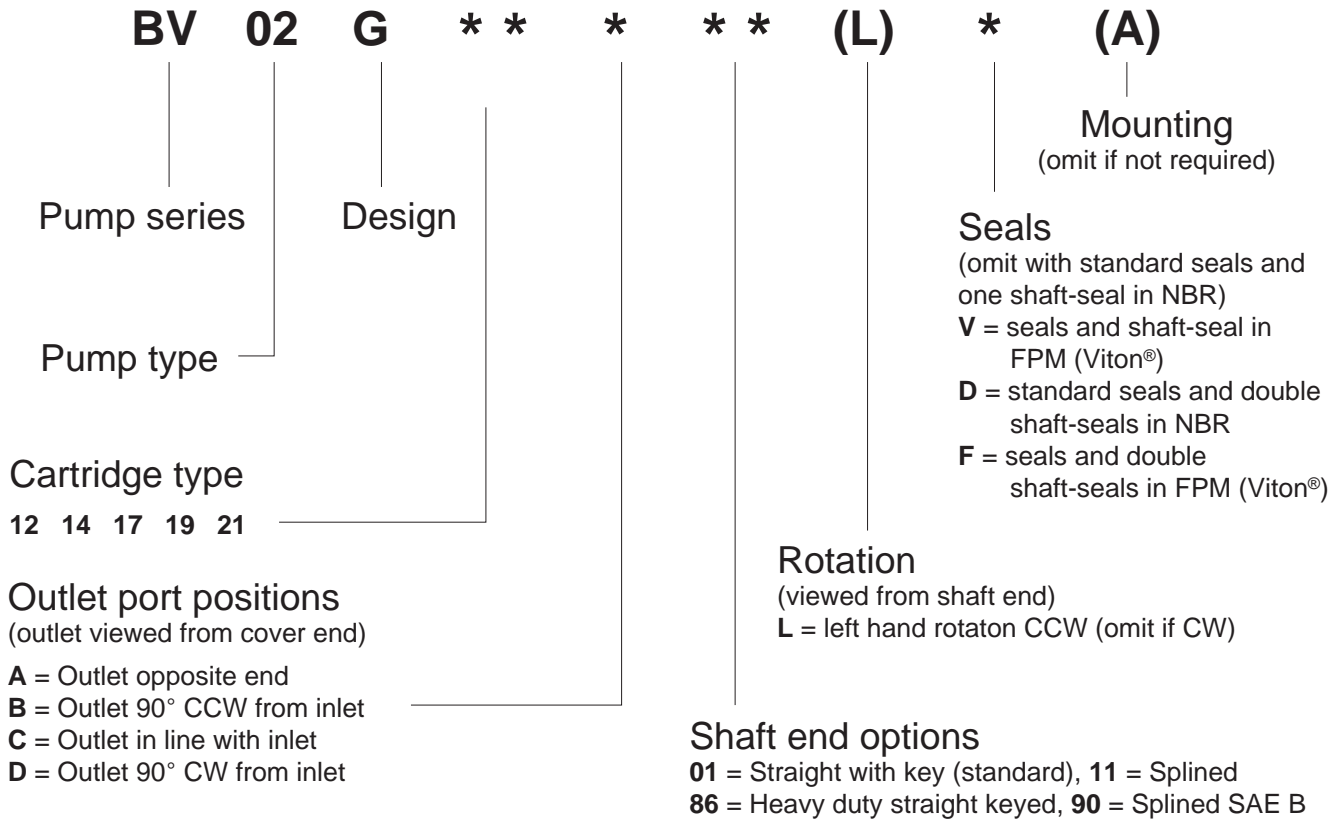

Shaft options mm (inches)

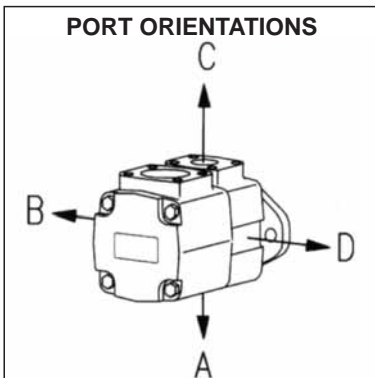
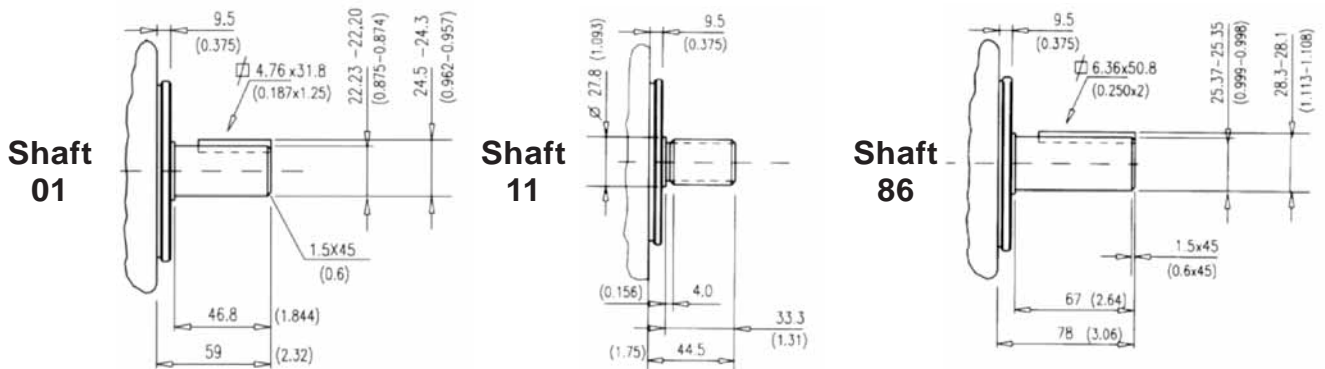

Spline data
(shaft 11 and shaft 90)

Spline	Involute side fit (ASA B5.15)	
Pressure angle	30°	
No. of teeth	13	
Pitch	16/32	
Major dia.	22.00 - 21.90	(0.866 - 0.862)
Pitch dia.	20.638	(0.8125)
Minor dia.	18.63 - 18.35	(0.733 - 0.722)
Wildhaber	11.67 - 11.70	(0.459 - 0.461)

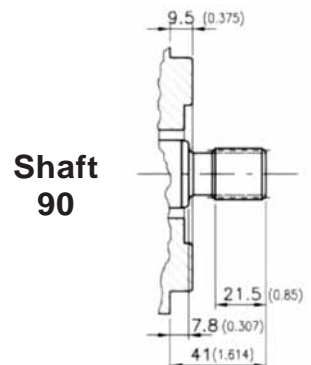

Id. codes of pump components

Cartridge			
Series	Model	Part No.	Pump rotat.
V02	12	V0212030	right hand
	14	V0214070	
	17	V0217110	
	19	V0219150	
	21	V0221190	
V02	12	V0212040	left hand
	14	V0214080	
	17	V0217120	
	19	V0219160	
	21	V0221200	

Shaft kit	
Model	Part No.
01	M8020601
11	M8020611
86	M8020686
90	M8020690

Shaft		Key	
Model	Part No.	Codice N°	
01	K0201000	M8010100	
11	K0211000	-	
86	K0286000	M8028600	
90	K0290000	-	

Body	
Part No.	
M8020010	

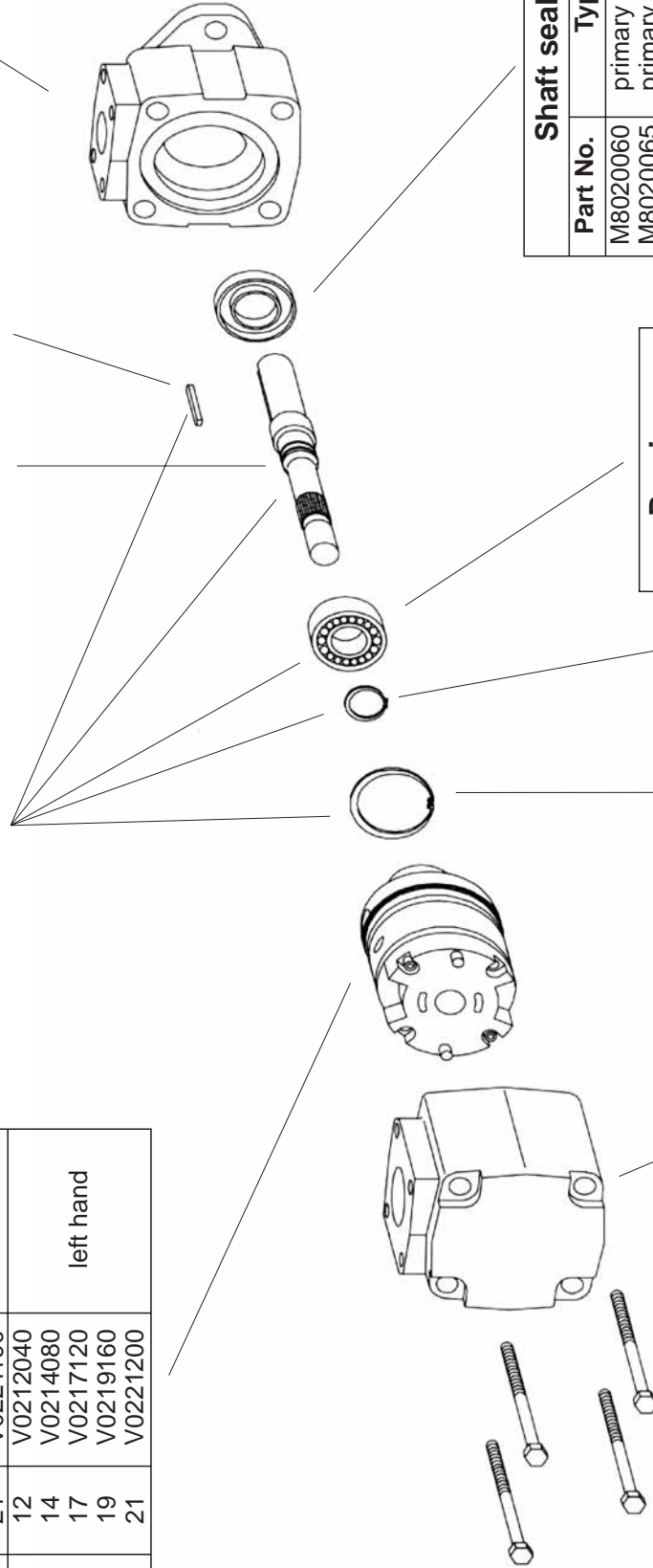

Shaft seal	
Part No.	Type
M8020060	primary in NBR
M8020065	primary in FPM
M8020061	secondary in NBR
M8020066	secondary in FPM

Bearing	
Part No.	
M8020030	

Seeger	
Part No.	
M8020050	

Seeger	
Part No.	
M8020040	

Cover	
Part No.	
M8020020	

Screw	
Part No.	
M8020070	
Torque to 102 Nm (910 lb. in.)	

Pump seal kit		
Part No.	Parts	Type
M8020500	seals + 1 shaft seal	NBR
M8020501	seals + 2 shaft seals	NBR
M8020503	seals + 1 shaft seal	FPM (Viton®)
M8020504	seals + 2 shaft seals	FPM (Viton®)

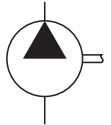
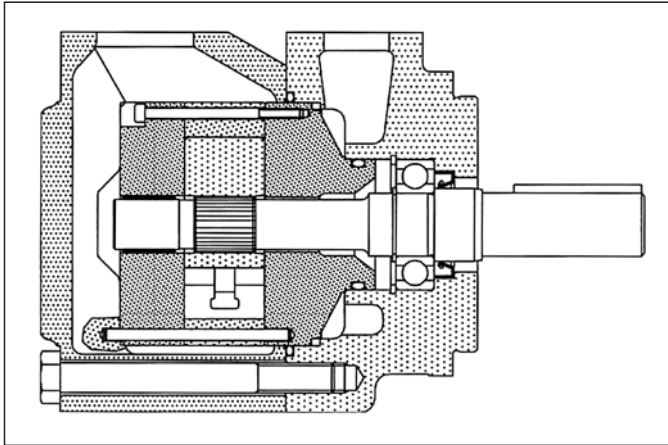

General description

Fixed displacement vane pump, hydraulically balanced, with capacity determined by the type of cartridge used and the speed of rotation. The pump is available in five versions with capacities from 80 to 140 l/min (*from 21 to 38 gpm*) at 1200 rpm and 7 bar.

Technical characteristics

Cartridge model	Geometric displacement		Rated capacity at 1200 rpm 7 bar		Rated capacity at 1500 rpm 7 bar		Maximum pressure with mineral oil		Speed range rpm	
	cm ³ /g	(in ³ /r)	l/min	(gpm)	l/min	(gpm)	bar	(psi)	min	max
V04-21	69,0	(4.2)	79,5	(21)	101,4	(26.8)	175	(2538)	600	1800
V04-25	81,6	(5)	94,0	(25)	120,1	(31.7)	175	(2538)	600	1800
V04-30	97,7	(6)	113,8	(30)	141,2	(37.3)	175	(2538)	600	1800
V04-35	112,7	(6.9)	131,6	(35)	167,2	(44.1)	175	(2538)	600	1800
V04-38	121,6	(7.4)	139,9	(38)	177,3	(46.8)	175	(2538)	600	1800

Hydraulic fluids: antiwear high quality mineral oils or fire resistant fluid having same lubrication capacities of the mineral oil.

Viscosity range (*with mineral oil*): from 13 to 860 cSt. (*13 to 54 cSt. recommended*).

Filtration: for the inlet - 149 micron abs., for the return line - 25 micron abs. or better (*with synthetic fluids: for the return line - 10 micron abs. or better*).

Inlet pressure: (*with mineral oil*): from -0,17 to +1,4 bar (*-2.5 to + 20 psi*)

Operating temperature: with mineral oil -10°C +70°C (*+30° C to +60° C recommended*), with water based fluids +15°C to +50°C.

Drive: direct and coaxial by means of a flexible coupling.

Main operating data

max pressure / hydraulic fluid

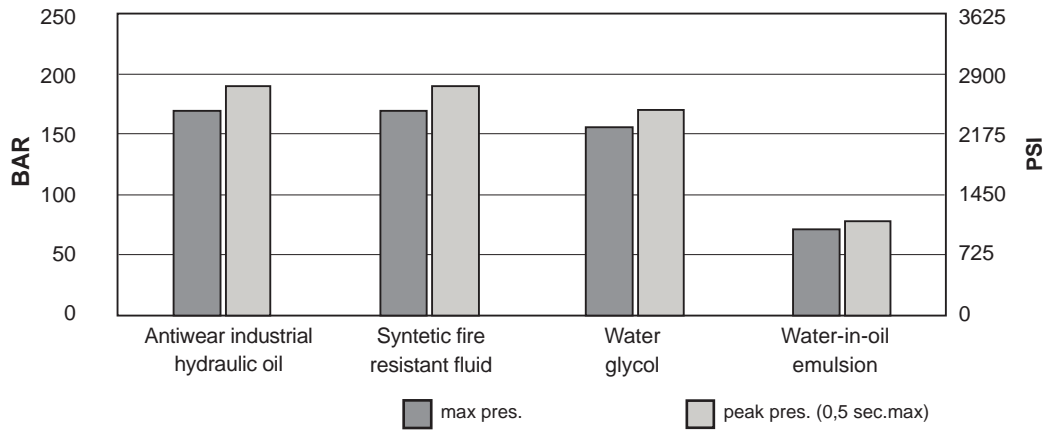

max speed / hydraulic fluid (with 0 bar in the intake pipe)

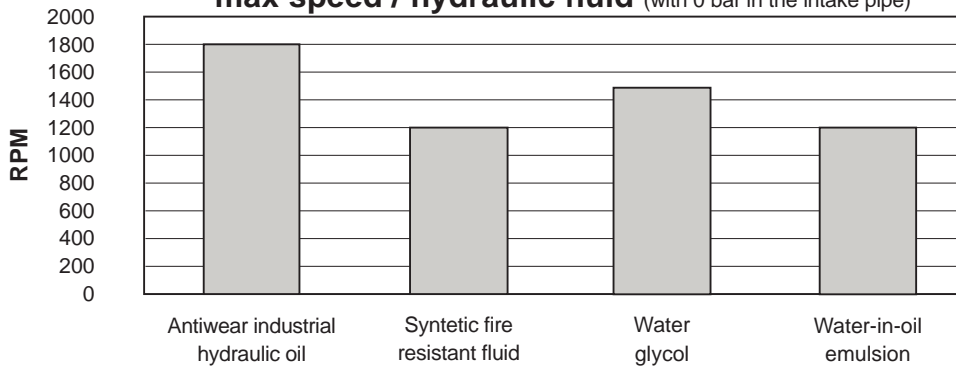

If the intake pressure is not zero bar, use the graph below to find the percentage correction factor to apply to the maximum speed

max speed / intake pipe pressure

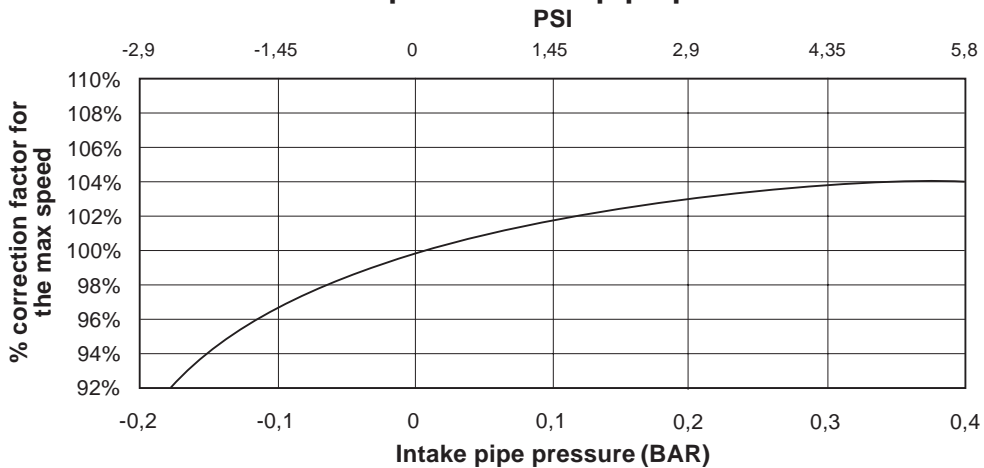

Sound level at 138 bar (2000 psi)

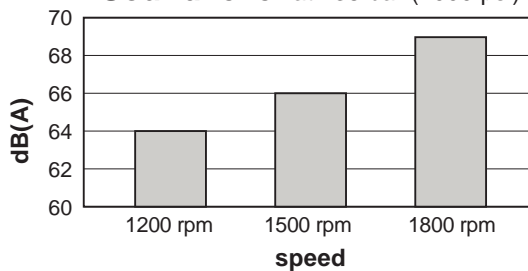

Cartridge V04-21

flow / pressure

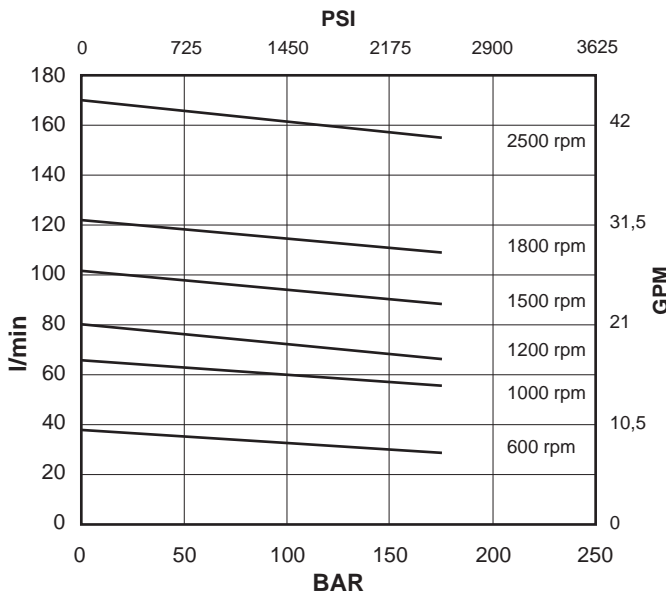

power / pressure

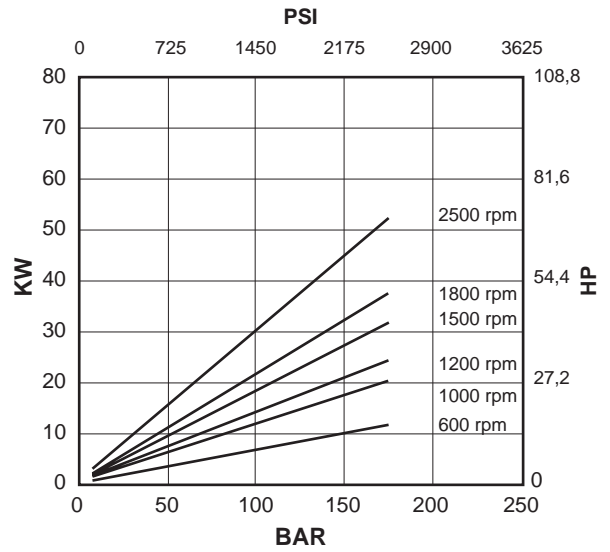

input torque / pressure

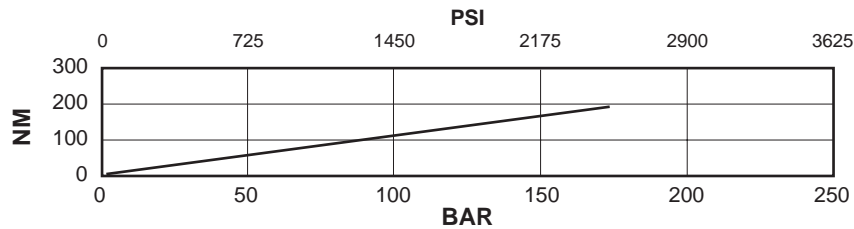

Oil viscosity: 25 c.St.(10W)
Temperature: 45°C
Inlet pressure: 0 BAR

Cartridge V04-25

flow / pressure

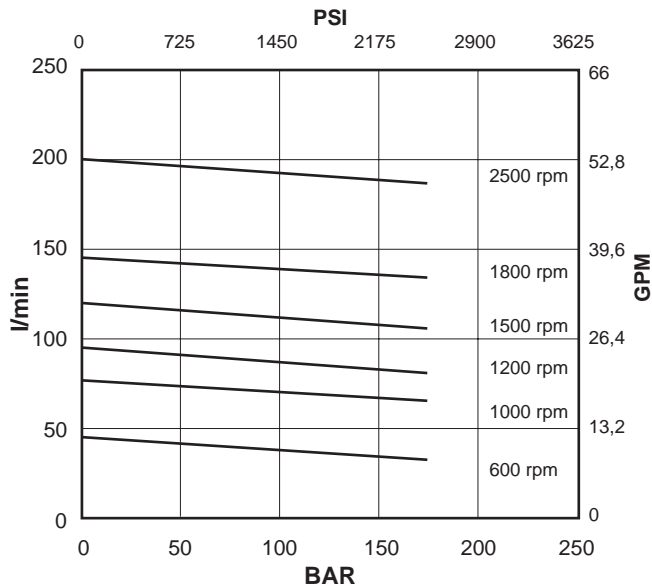

power / pressure

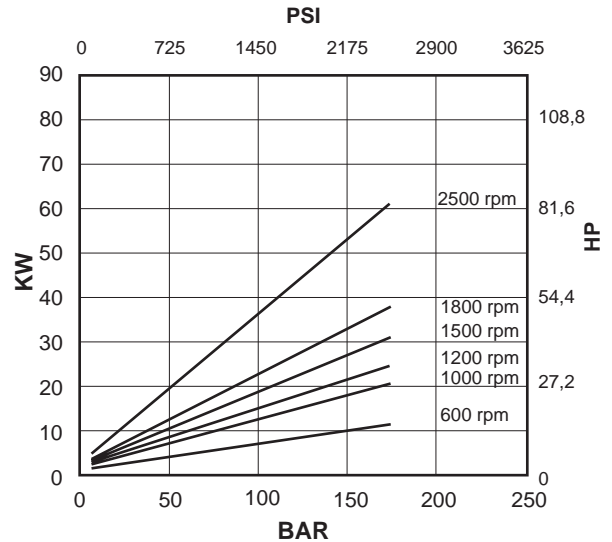

input torque / pressure

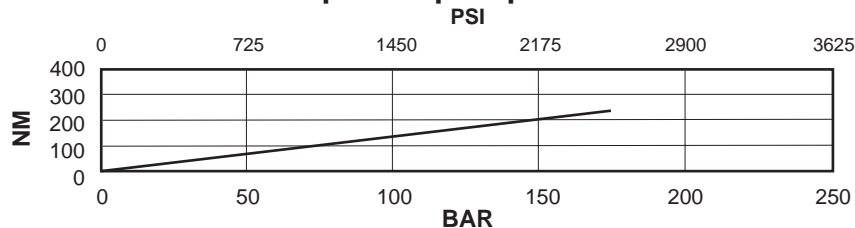

Oil viscosity: 25 c.St.(10W)
Temperature: 45°C
Inlet pressure: 0 BAR

Cartridge V04-30

flow / pressure

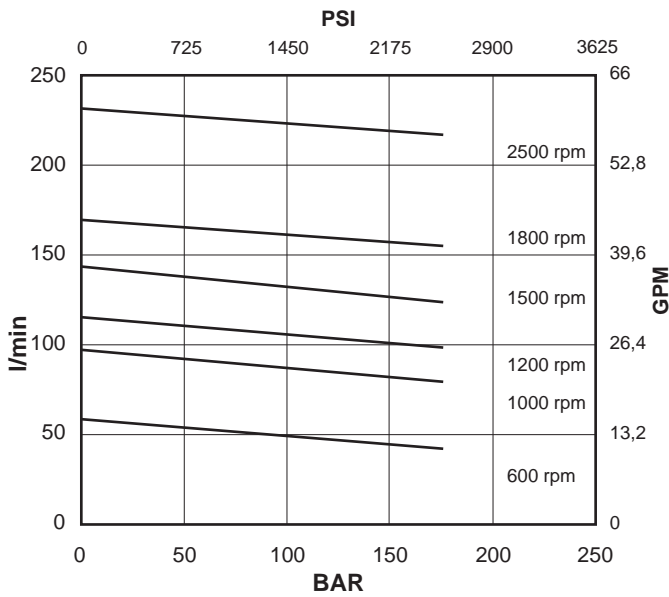

power / pressure

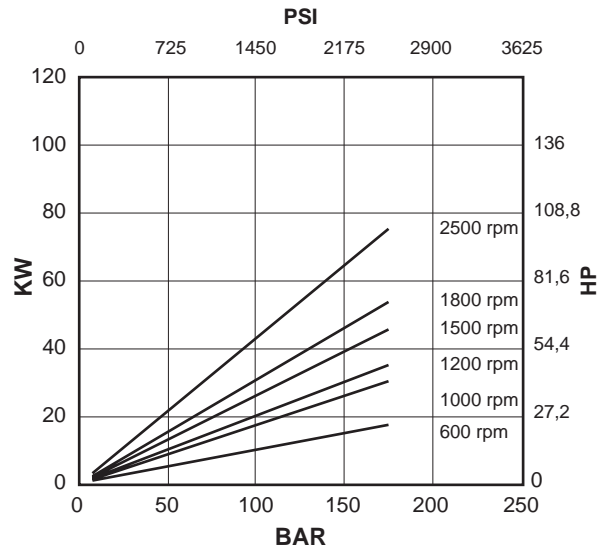

input torque / pressure

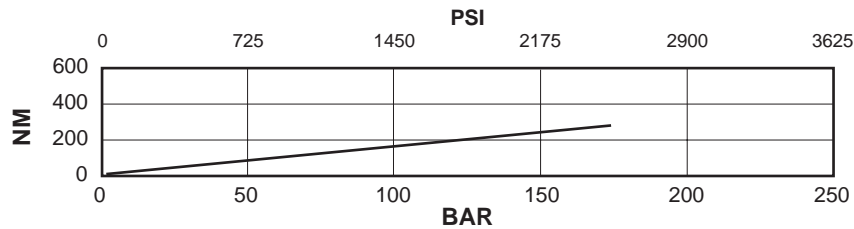

Oil viscosity: 25 c.St.(10W)
Temperature: 45°C
Inlet pressure: 0 BAR

Cartridge V04-35

flow / pressure

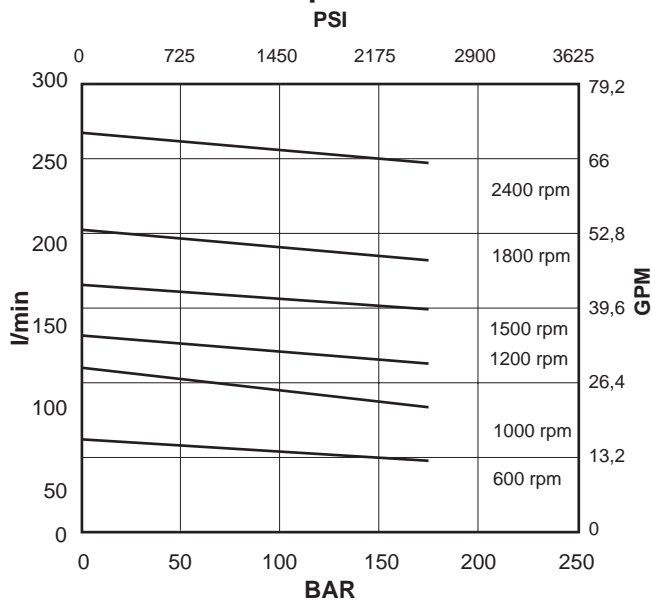

power / pressure

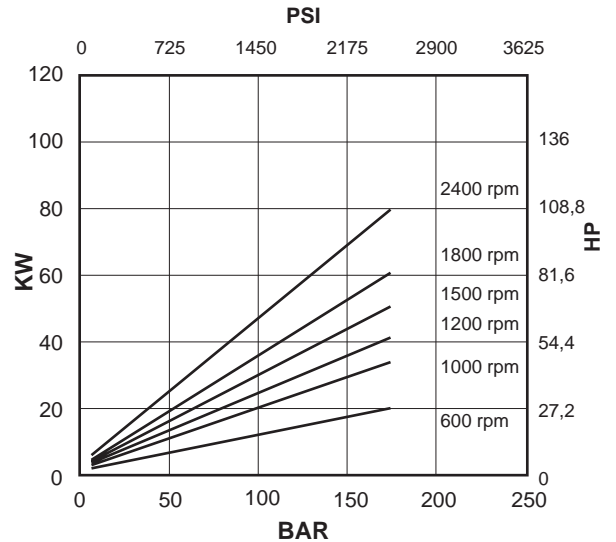

input torque / pressure

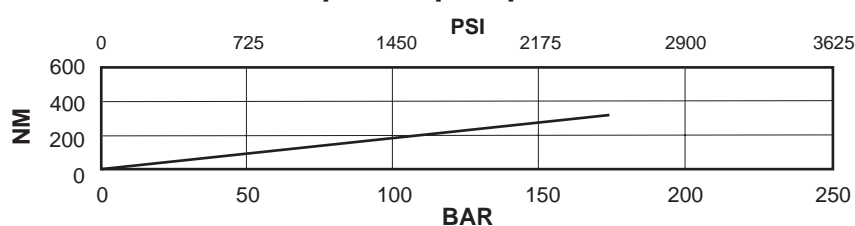

Oil viscosity: 25 c.St.(10W)
Temperature: 45°C
Inlet pressure: 0 BAR

Cartridge V04-38

flow / pressure

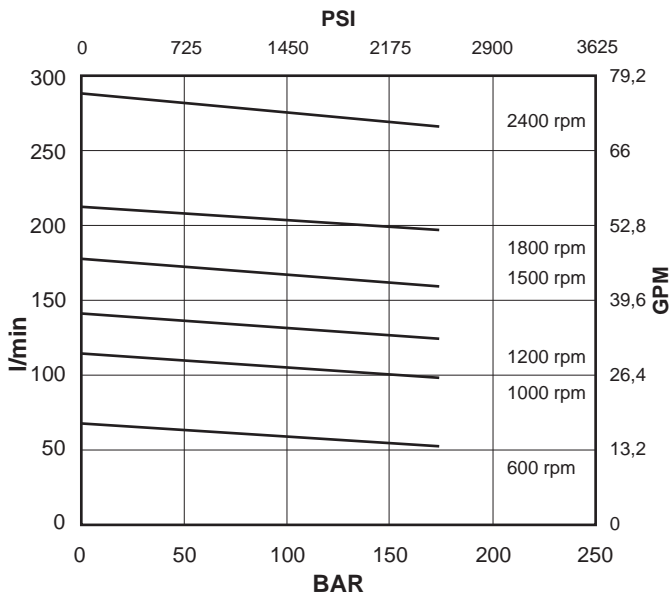

power / pressure

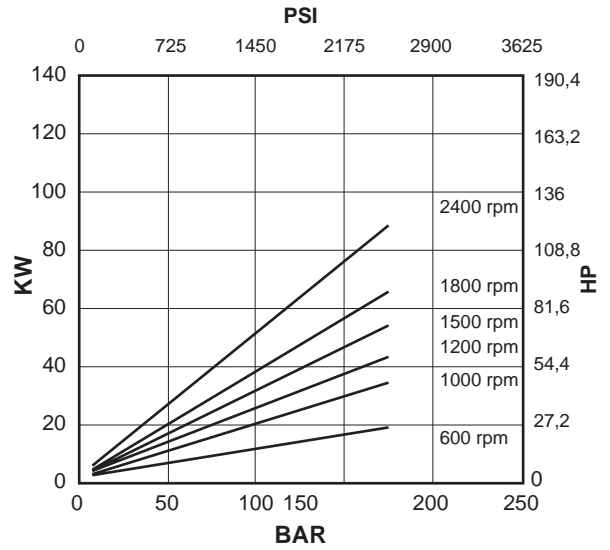

input torque / pressure

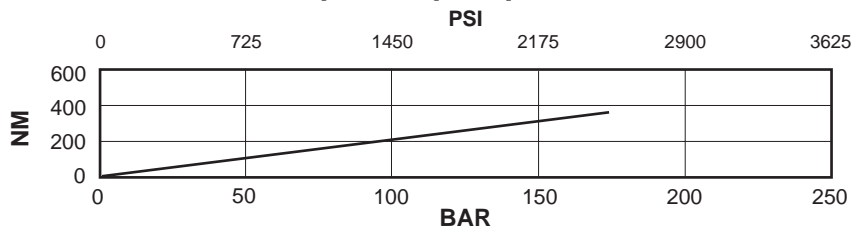

Oil viscosity: 25 c.St.(10W)
Temperature: 45°C
Inlet pressure: 0 BAR

Installation dimensions mm (inches)

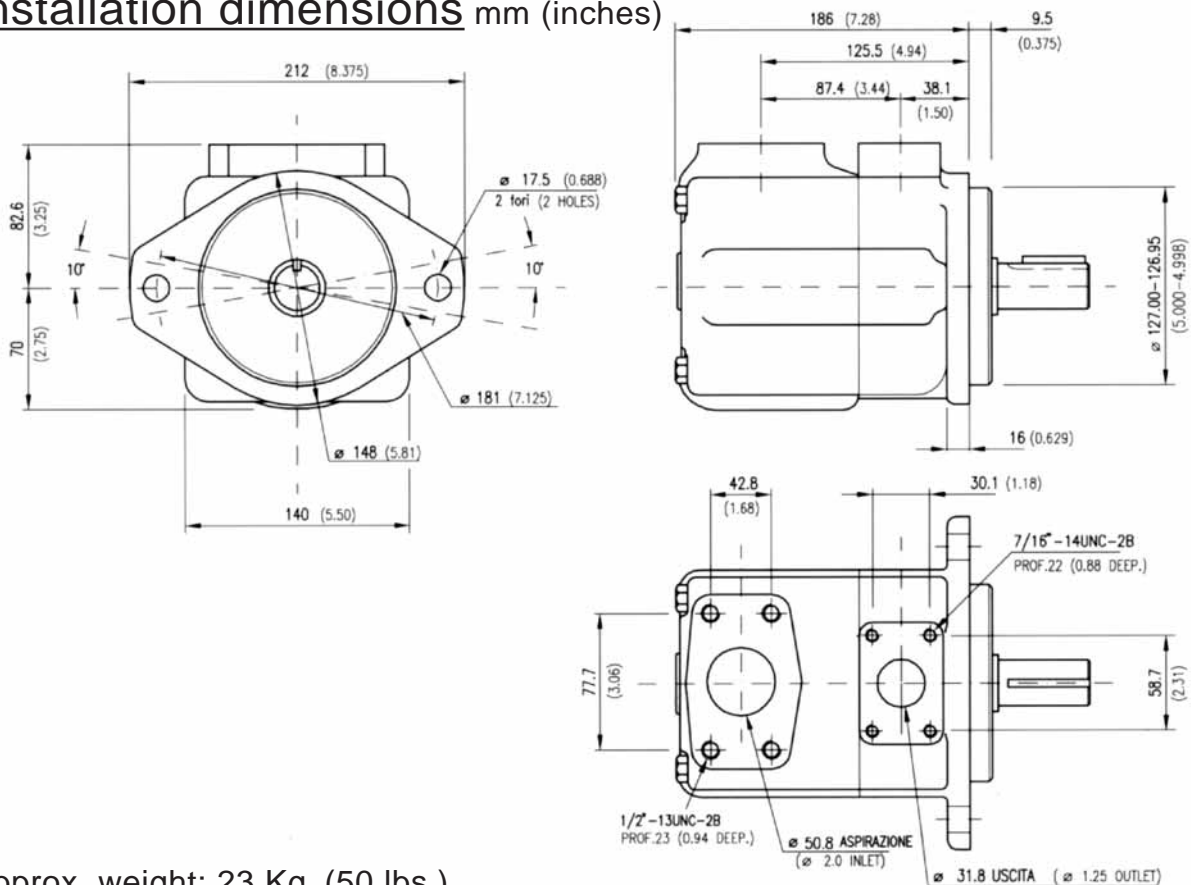

Approx. weight: 23 Kg. (50 lbs.)

Model code breakdown

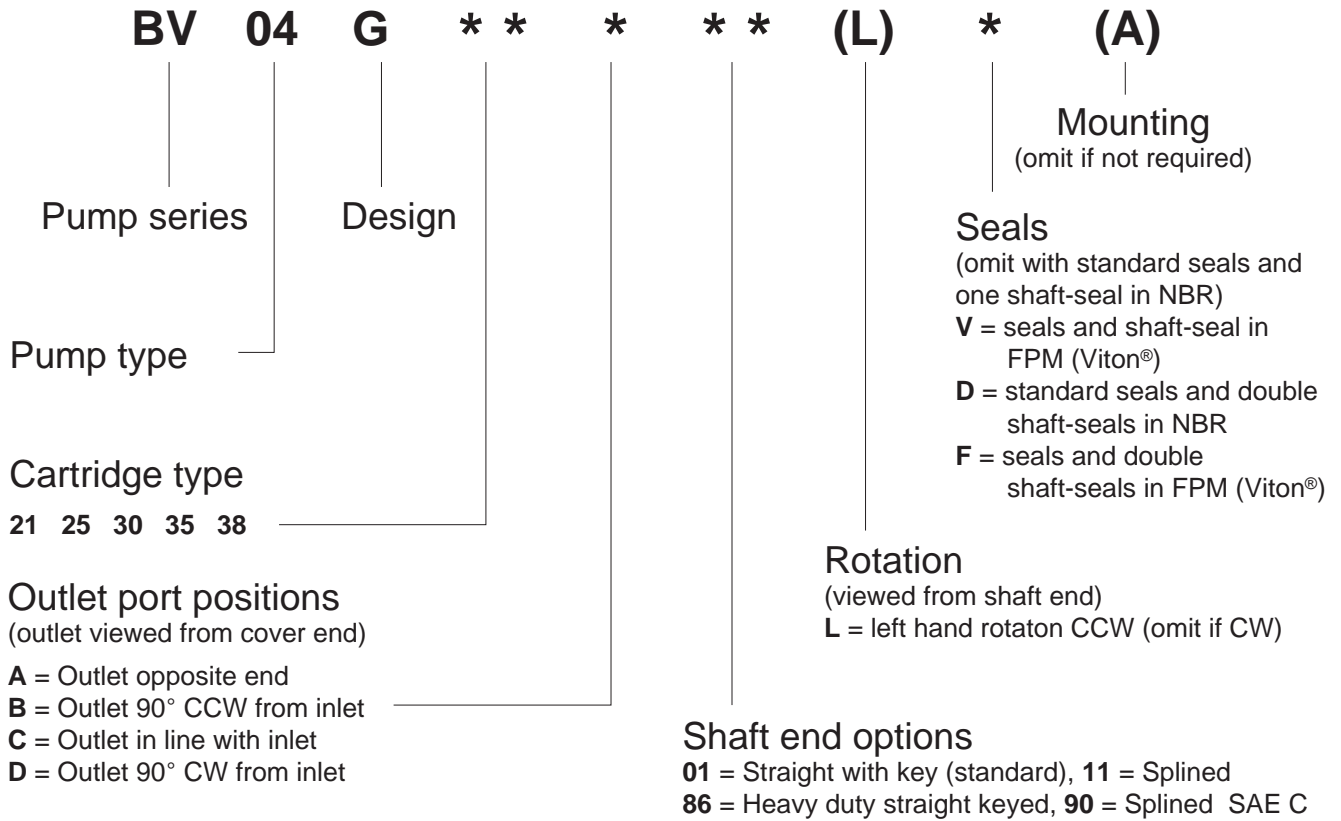

Shaft options mm (inches)

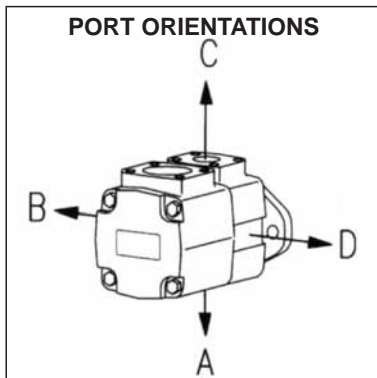
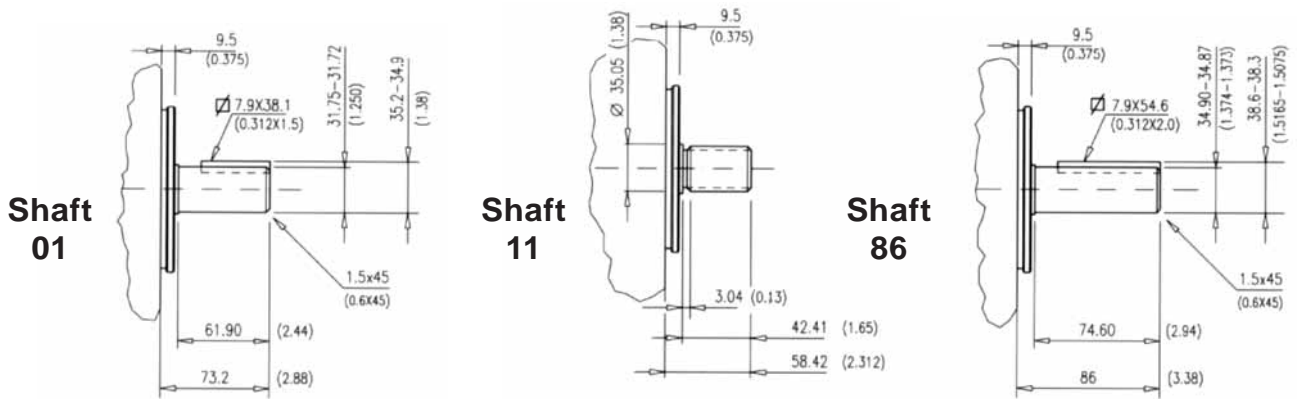

Spline data
(shaft 11 and shaft 90)

Spline	Involute side fit (ASA B5.15)	
Pressure angle	30°	
No. of teeth	14	
Pitch	12/24	
Major dia.	31.60 - 31.50	(1.244 - 1.240)
Pitch dia.	29.634	(1.1667)
Minor dia.	26.99 - 26.66	(1.0627 - 1.05)
Wildhaber	15.68 - 15.73	(0.617 - 0.619)

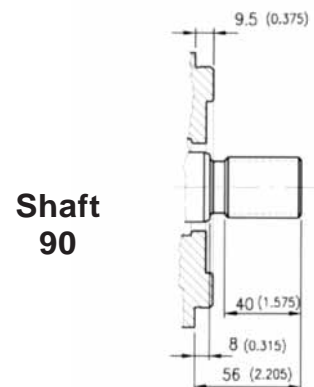

Id. codes of pump components

Cartridge			
Series	Model	Part No.	Pump rotat.
V04	21	V0421030	right hand
	25	V0425070	
	30	V0430110	
	35	V0435150	
	38	V0438190	
V04	21	V0421040	left hand
	25	V0425080	
	30	V0430120	
	35	V0435160	
	38	V0438200	

Shaft kit	
Model	Part No.
01	M8040601
11	M8040611
86	M8040686
90	M8040690

Shaft		Key	
Model	Part No.	Part No.	Part No.
01	K0401000	M8040100	
11	K0411000	-	
86	K0486000	M8048600	
90	K0490000	-	

Body	
Part No.	Part No.
M8040140	

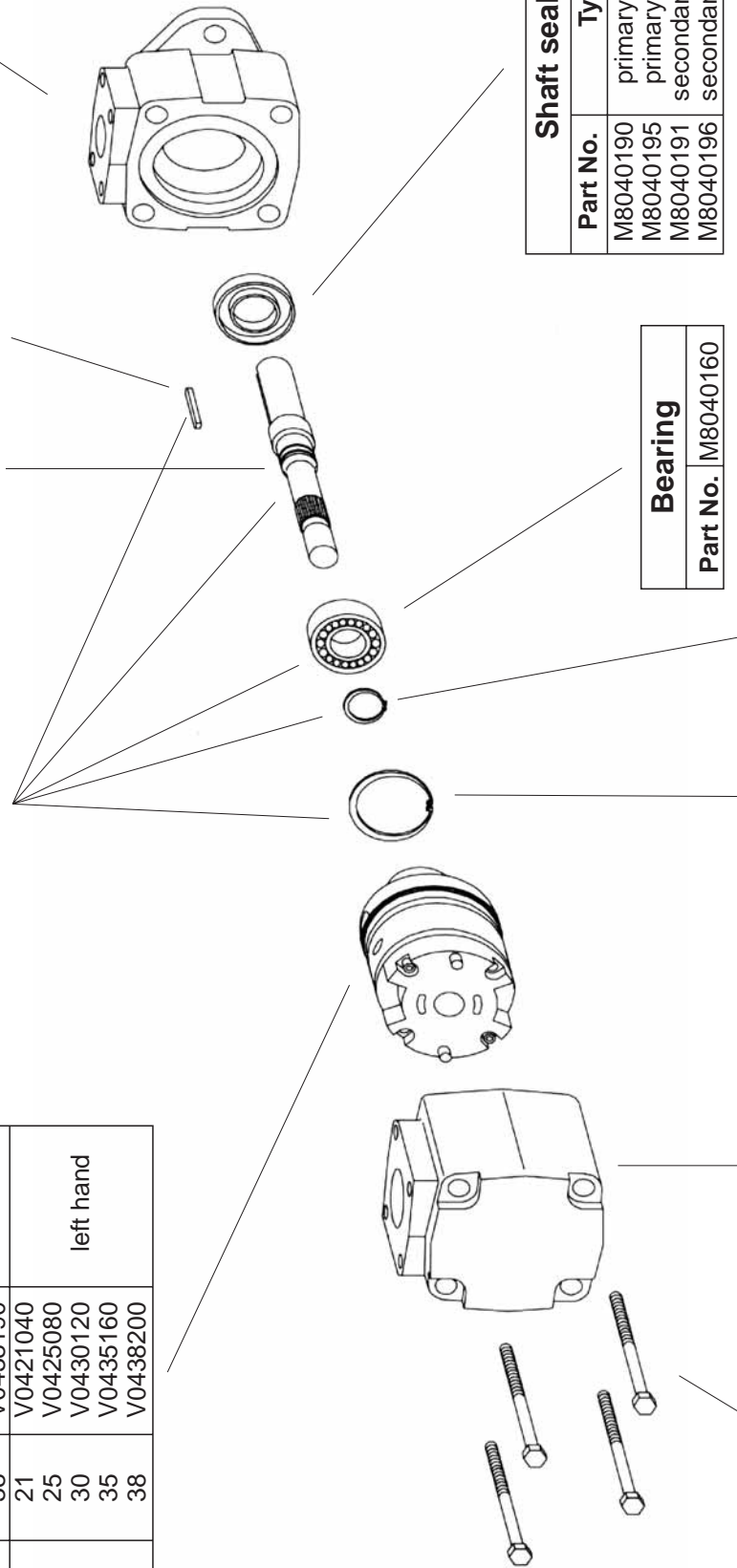

Shaft seal	
Part No.	Type
M8040190	primary in NBR
M8040195	primary in FPM
M8040191	secondary in NBR
M8040196	secondary in FPM

Bearing	
Part No.	Part No.
M8040160	

Seeger	
Part No.	Part No.
M8040180	

Seeger	
Part No.	Part No.
M8040170	

Cover	
Part No.	Part No.
M8040150	

Screw	
Part No.	Part No.
M8040200	
Torque to 225 Nm (2010 lb. in.)	

Pump seal kit		
Part No.	Parts	Type
M8040500	seals + 1 shaft seal	NBR
M8040501	seals + 2 shaft seals	NBR
M8040503	seals + 1 shaft seal	FPM (Viton®)
M8040504	seals + 2 shaft seals	FPM (Viton®)

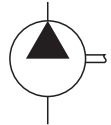
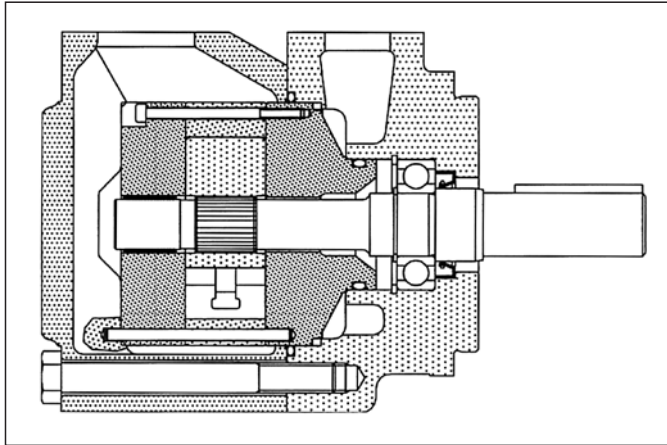

General description

Fixed displacement vane pump, hydraulically balanced, with capacity determined by the type of cartridge used and the speed of rotation. The pump is available in five versions with capacities from 164 to 230 l/min (from 42 to 60 gpm) at 1200 rpm and 7 bar.

Technical characteristics

Cartridge model	Geometric displacement		Rated capacity at 1200 rpm 7 bar		Rated capacity at 1500 rpm 7 bar		Maximum pressure with mineral oil		Speed range rpm	
	cm ³ /g	(in ³ /r)	l/min	(gpm)	l/min	(gpm)	bar	(psi)	min	max
V05-42	138,6	(8.46)	164	(42)	203,4	(53.7)	175	(2538)	600	1800
V05-47	153,5	(9.4)	180	(47)	222,7	(58.8)	175	(2538)	600	1800
V05-50	162,2	(9.9)	189	(50)	234	(61.8)	175	(2538)	600	1800
V05-57	183,4	(11.2)	217	(57)	267	(71.2)	175	(2538)	600	1800
V05-60	193,4	(11.8)	230	(60)	285	(75.3)	175	(2538)	600	1800

Hydraulic fluids: antiwear high quality mineral oils or fire resistant fluid having same lubrication capacities of the mineral oil.

Viscosity range (with mineral oil): from 13 to 860 cSt. (13 to 54 cSt. recommended).

Filtration: for the inlet - 149 micron abs., for the return line - 25 micron abs. or better (with synthetic fluids: for the return line - 10 micron abs. or better).

Inlet pressure: (with mineral oil): from -0,17 to +1,4 bar (-2.5 to + 20 psi)

Operating temperature: with mineral oil -10°C +70°C (+30°C to +60°C recommended), with water based fluids +15°C to +50°C.

Drive: direct and coaxial by means of a flexible coupling.

Main operating data

max pressure / hydraulic fluid

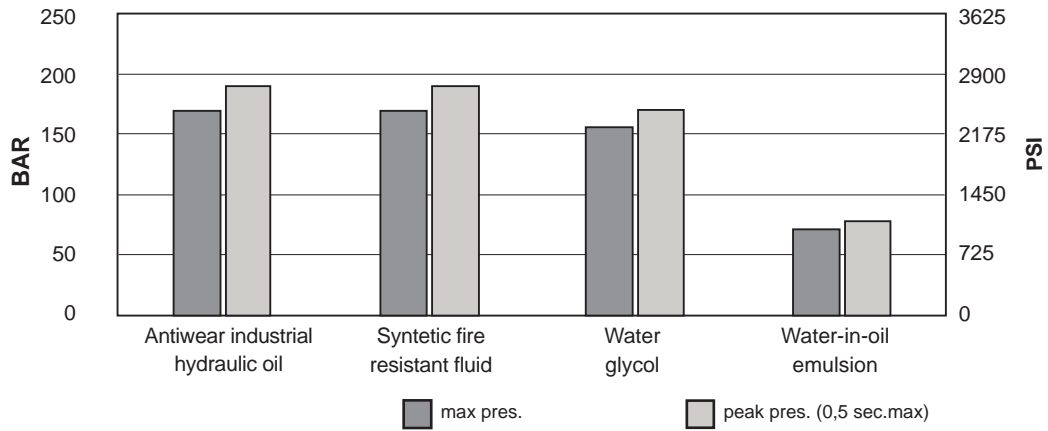

max speed / hydraulic fluid (with 0 bar in the intake pipe)

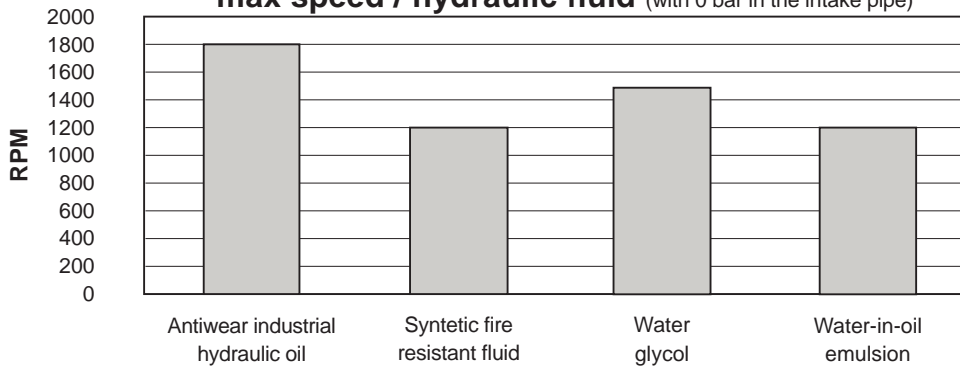

If the intake pressure is not zero bar, use the graph below to find the percentage correction factor to apply to the maximum speed

max speed / intake pipe pressure

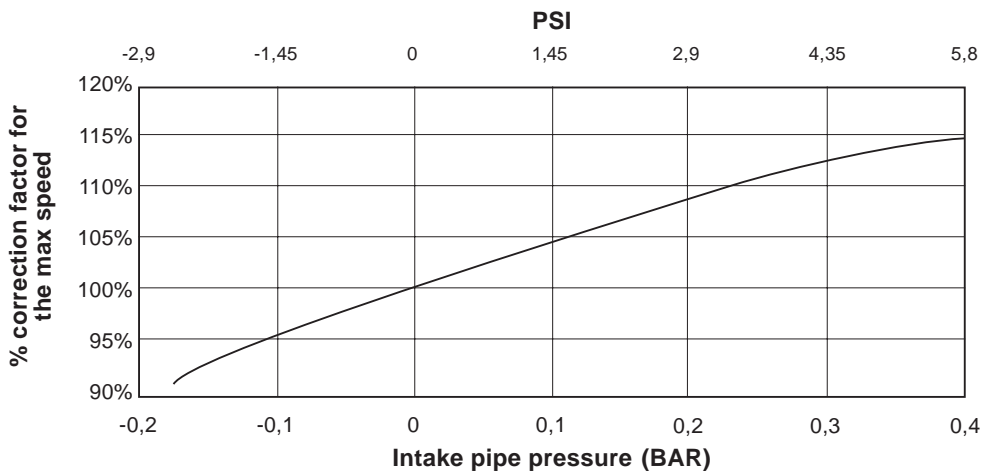

Sound level at 138 bar (2000 psi)

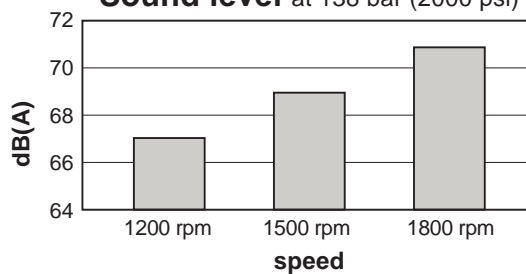

Cartridge V05-42

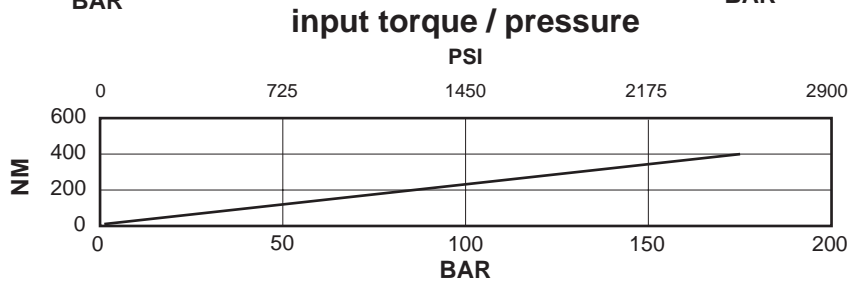
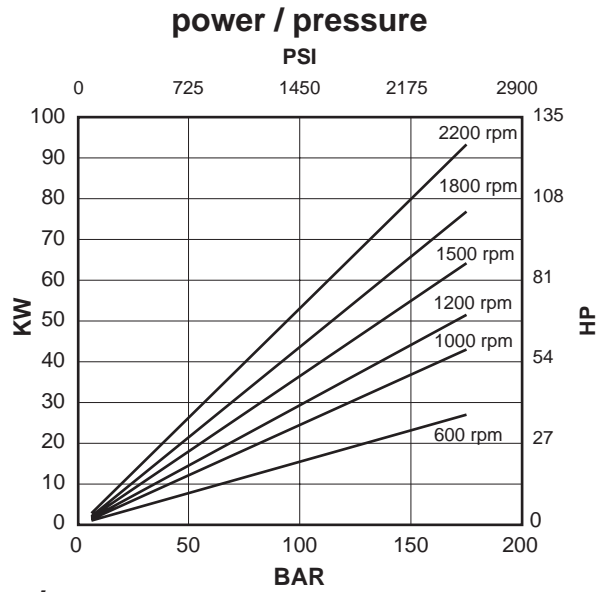
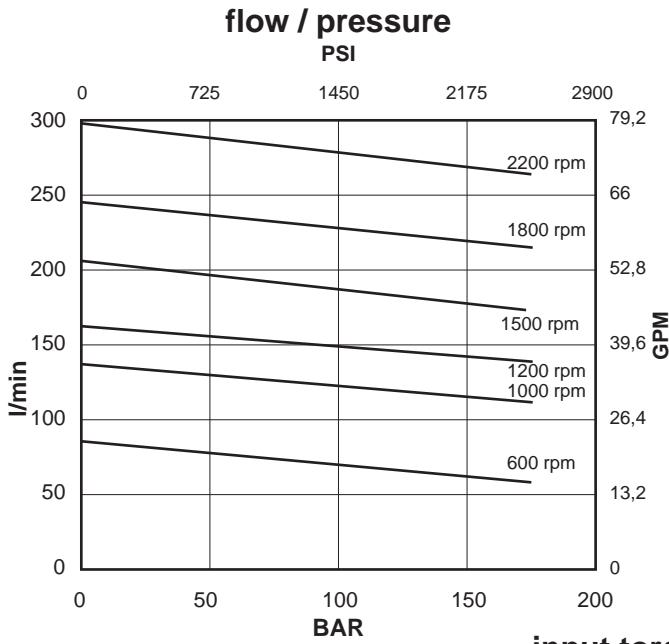

Oil viscosity: 25 c.St.(10W)
 Temperature: 45°C
 Inlet pressure: 0 BAR

Cartridge V05-47

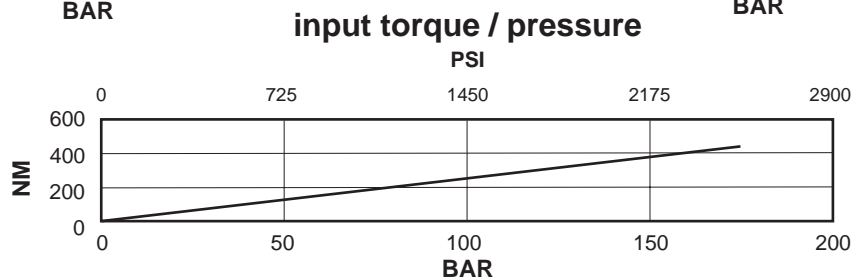
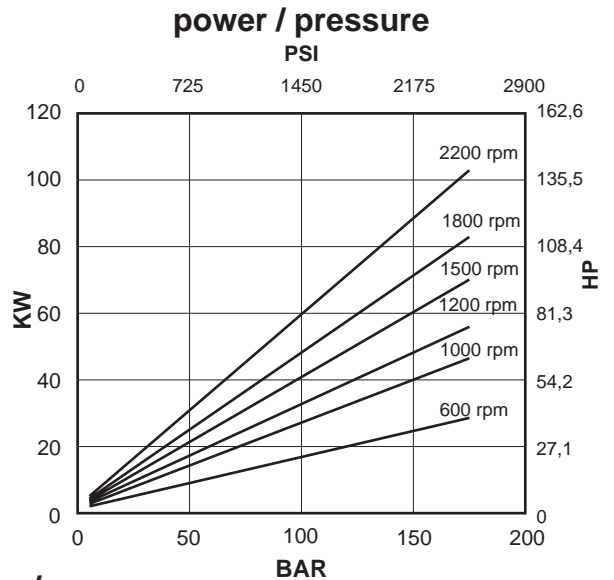
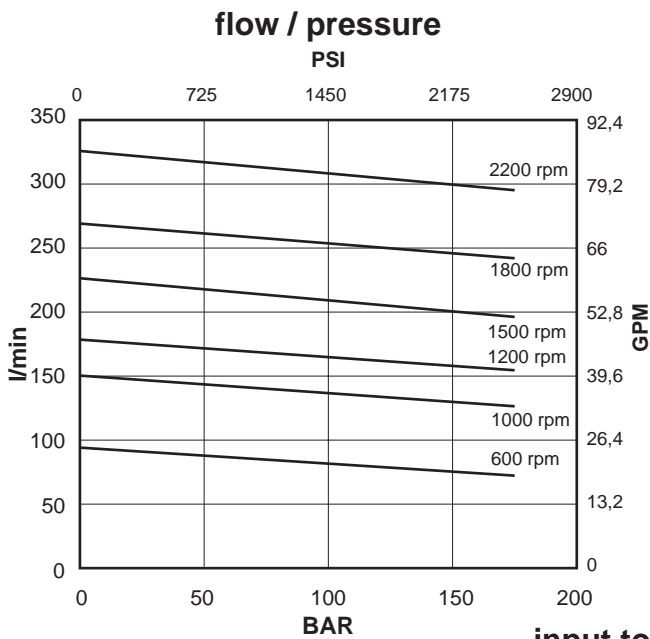

Oil viscosity: 25 c.St.(10W)
 Temperature: 45°C
 Inlet pressure: 0 BAR

Cartridge V05-50

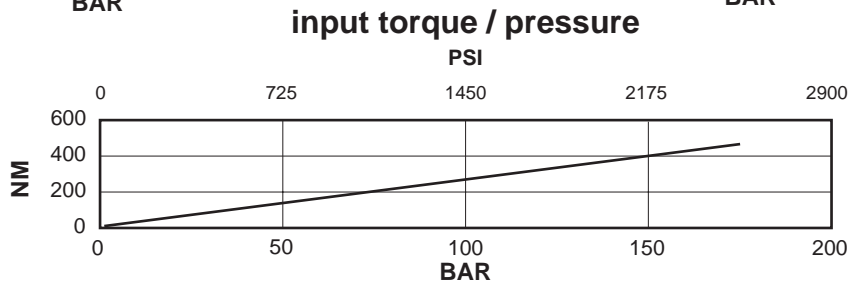
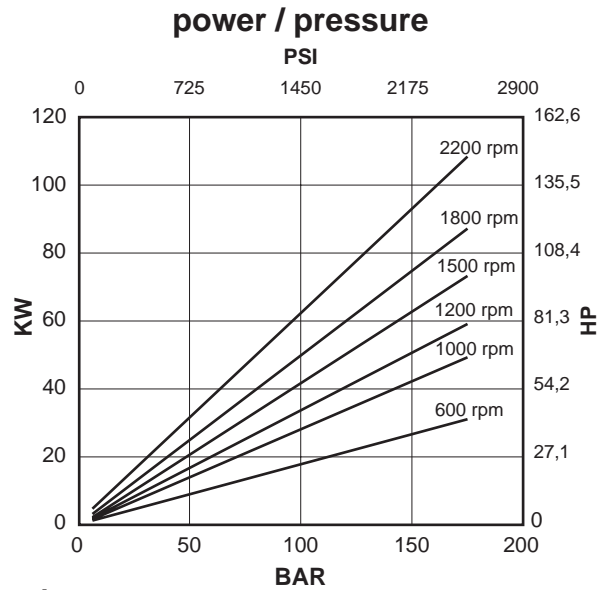
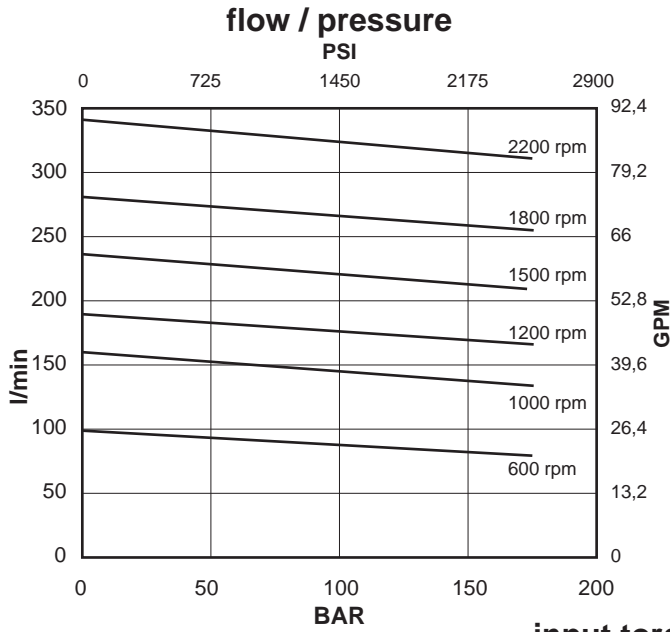

Oil viscosity: 25 c.St.(10W)
 Temperature: 45°C
 Inlet pressure: 0 BAR

Cartridge V05-57

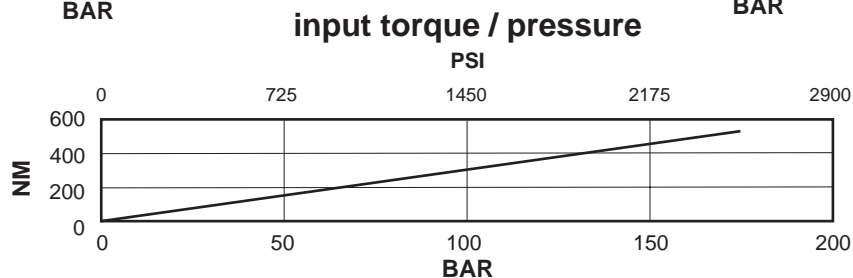
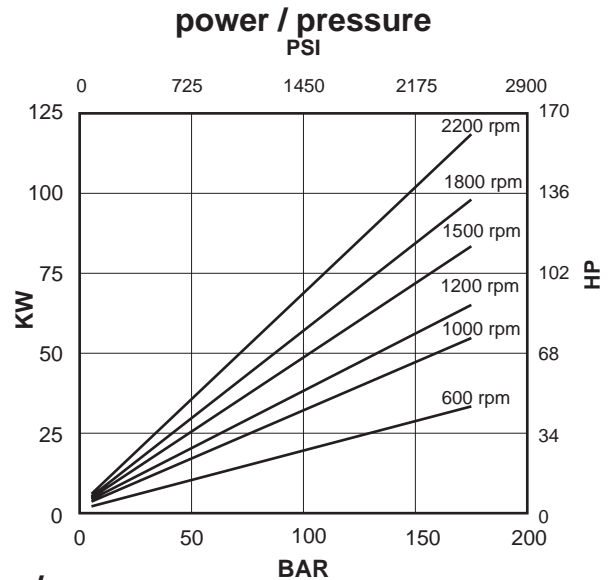
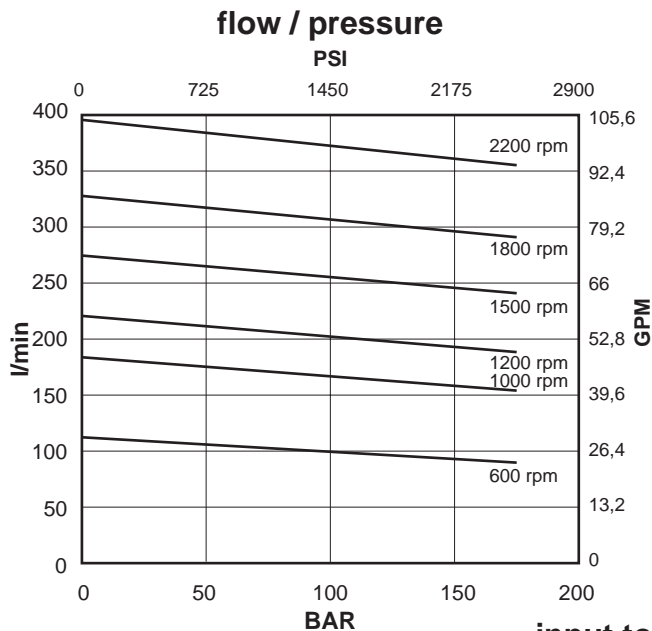

Oil viscosity: 25 c.St.(10W)
 Temperature: 45°C
 Inlet pressure: 0 BAR

Cartridge V05-60

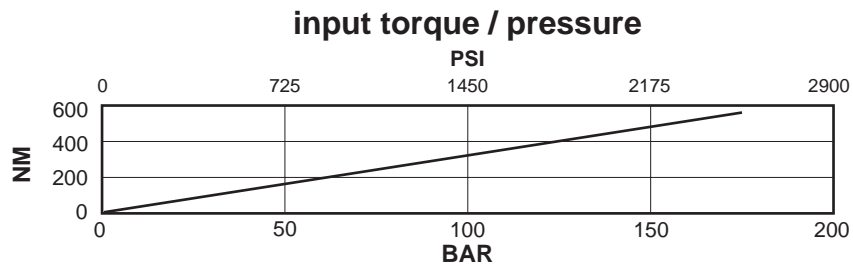
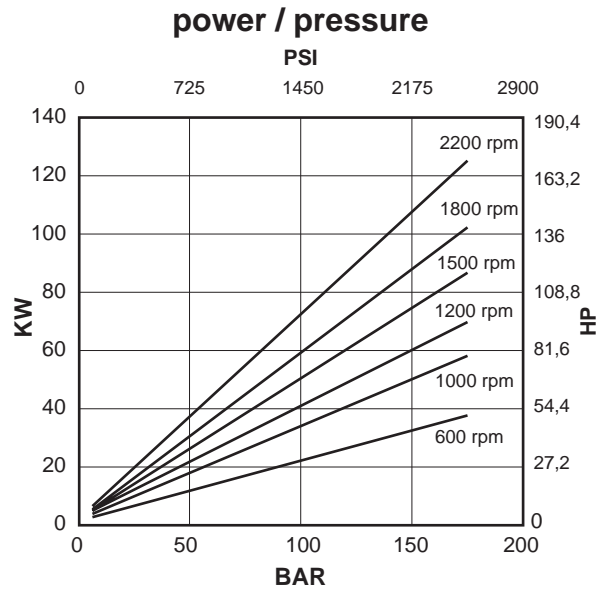
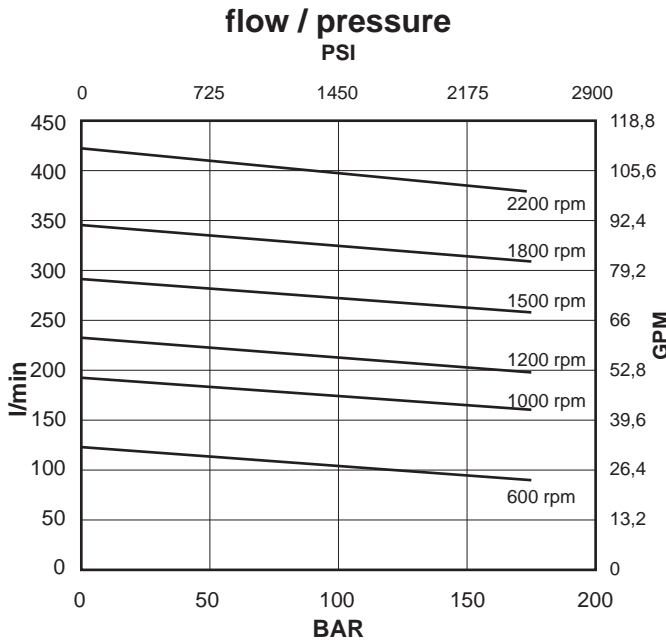

Oil viscosity: 25 c.St.(10W)
 Temperature: 45°C
 Inlet pressure: 0 BAR

Installation dimensions mm (inches)

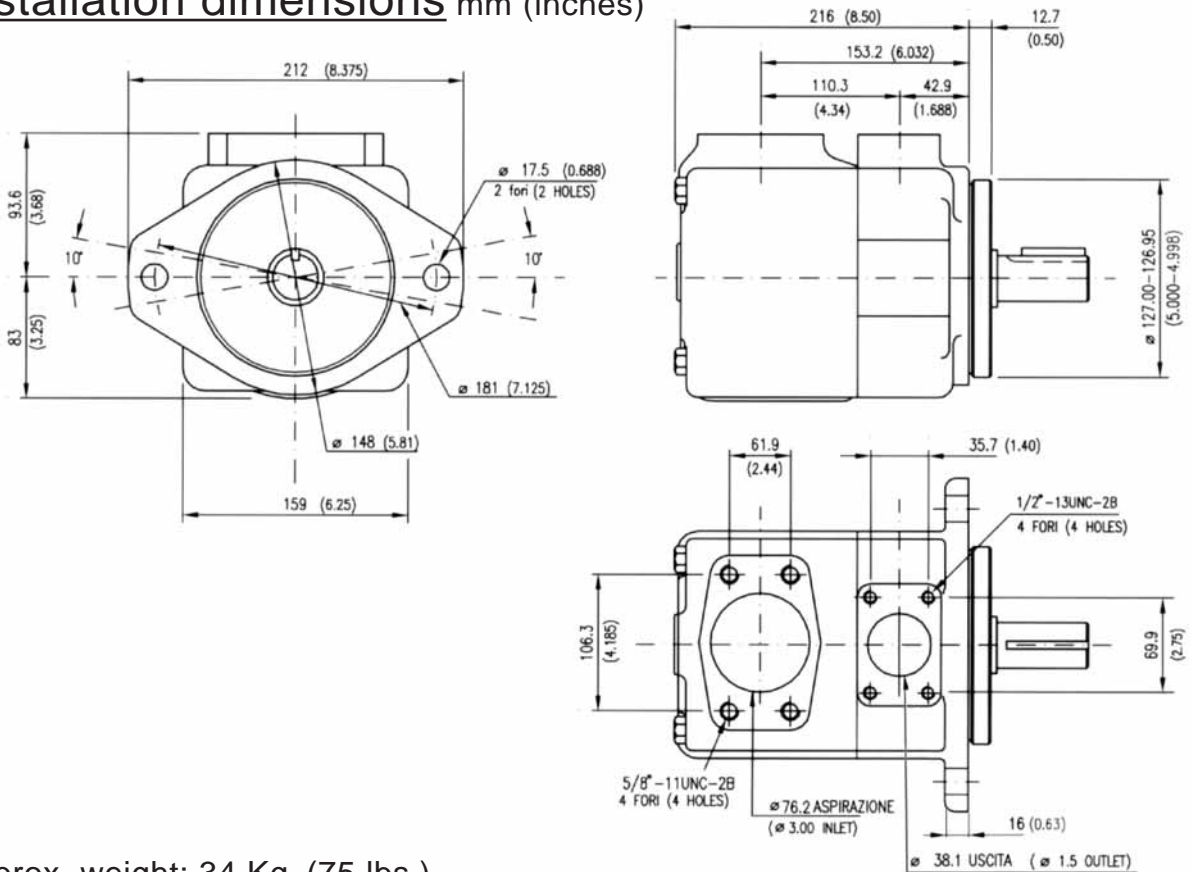

Approx. weight: 34 Kg. (75 lbs.)

Model code breakdown

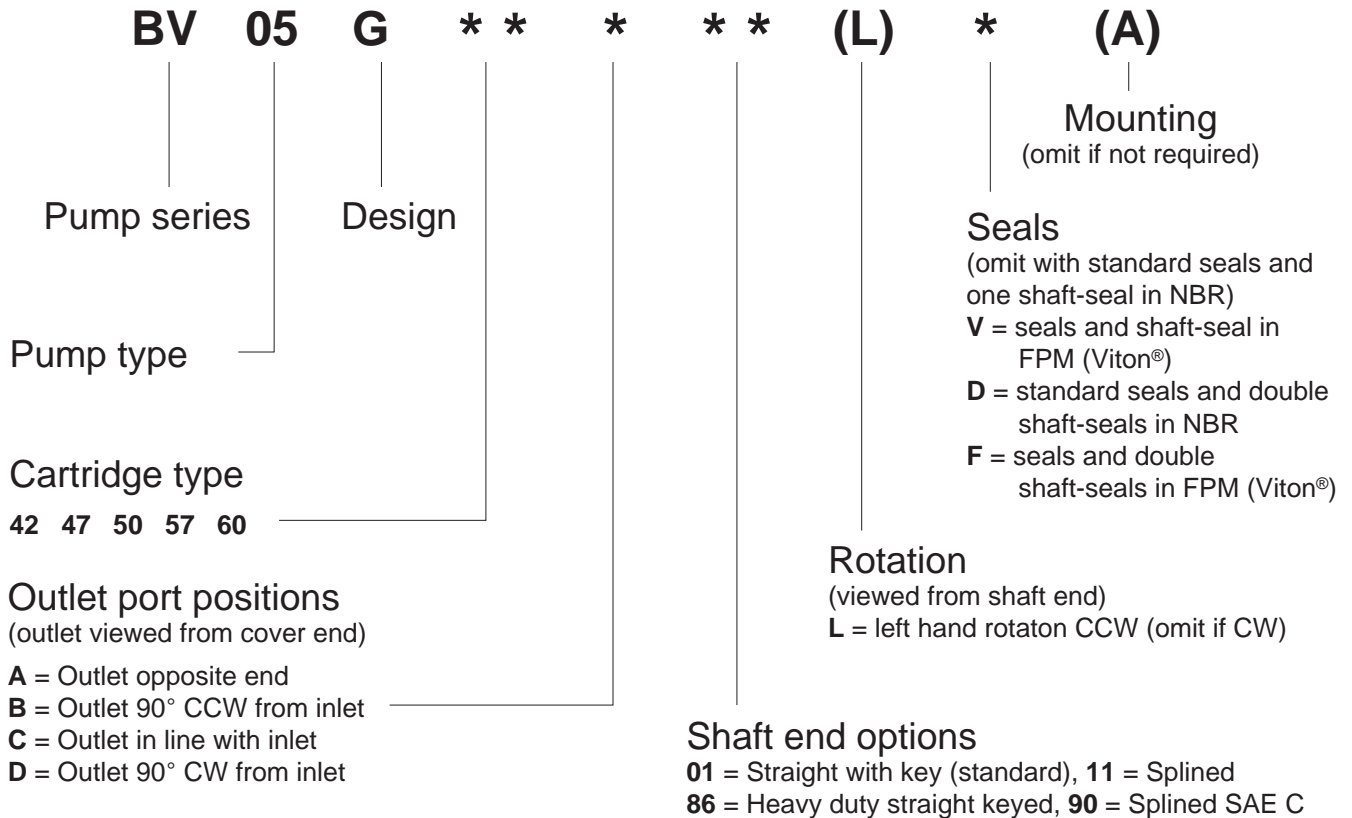

Shaft options mm (inches)

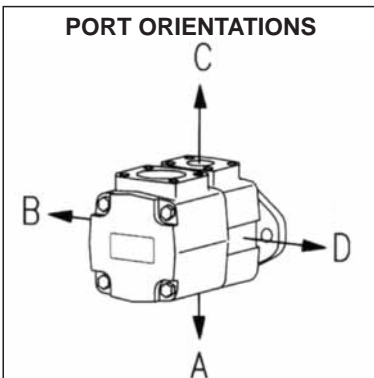
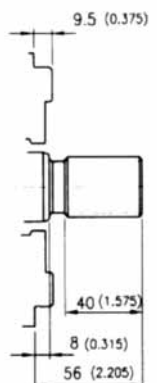
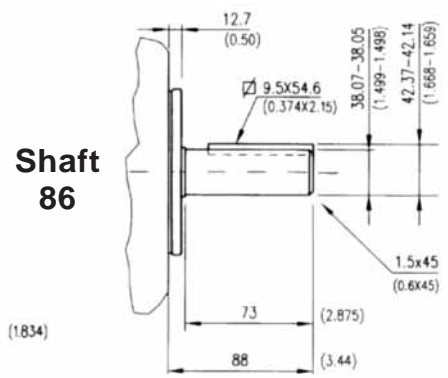
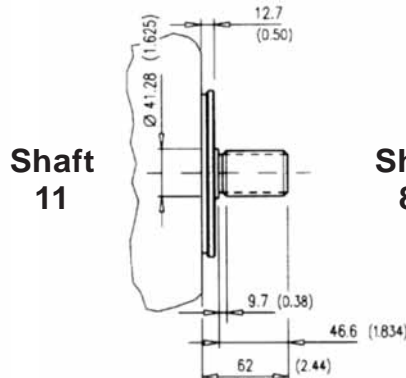
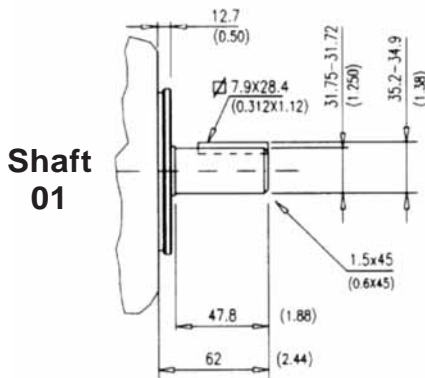

Spline data
(shaft 11 and shaft 90)
Involute side fit (ASA B5.15)

Spline	
Pressure angle	30°
No. of teeth	14
Pitch	12/24
Major dia.	31.60 - 31.50 (1.244 - 1.240)
Pitch dia.	29.634 (1.1667)
Minor dia.	26.99 - 26.66 (1.0627 - 1.05)
Wildhaber	15.68 - 15.73 (0.617 - 0.619)

Id. codes of pump components

Cartridge			
Series	Model	Part No.	Pump rotat.
V05	42	V0542010	right hand
	47	V0547030	
	50	V0550050	
	57	V0557070	
	60	V0560090	
V05	42	V0542020	left hand
	47	V0547040	
	50	V0550060	
	57	V0557080	
	60	V0560100	

Shaft kit	
Model	Part No.
01	M8050601
11	M8050611
86	M8050686
90	M8050690

Shaft		Key	
Model	Part No.	Part No.	Part No.
01	K0501000	M8050100	
11	K0511000	-	
86	K0586000	M80586600	
90	K0590000	-	

Body	
Part No.	M8050250

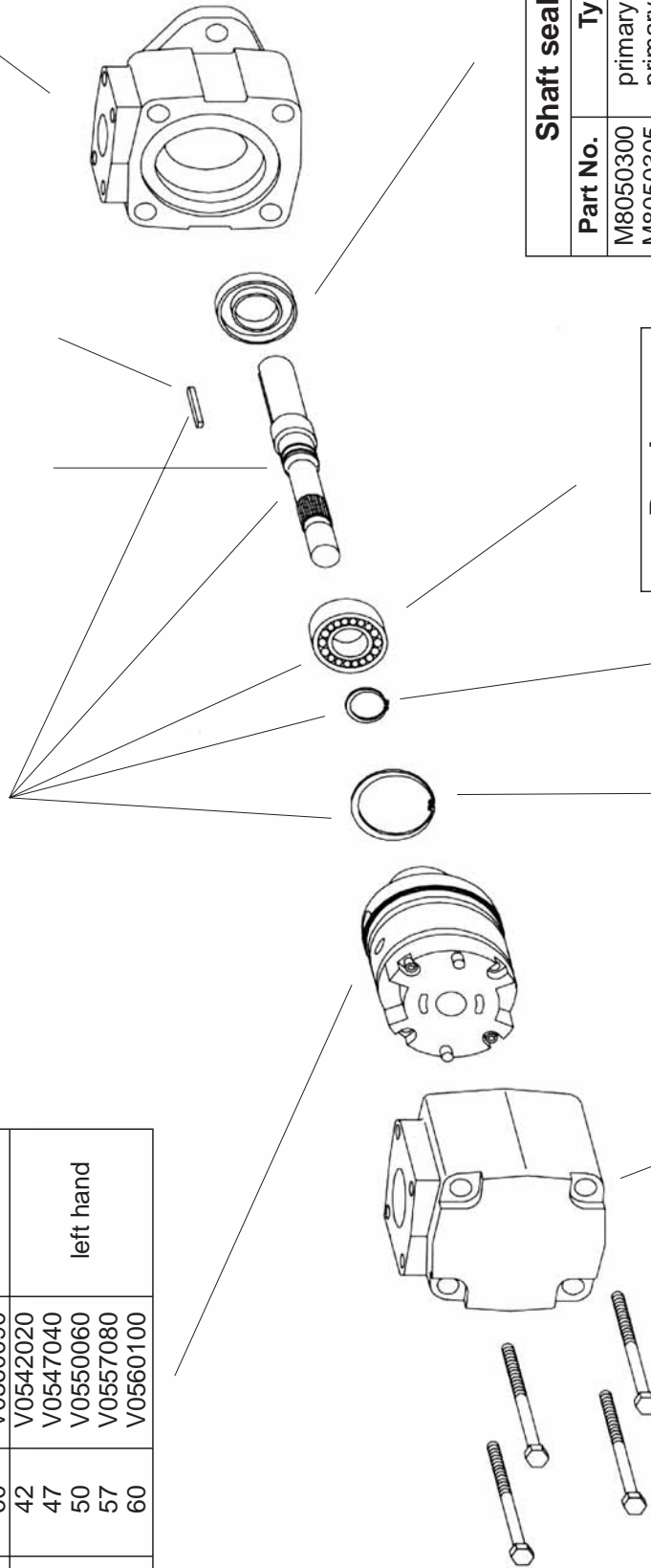

Shaft seal	
Part No.	Type
M8050300	primary in NBR
M8050305	primary in FPM
M8050301	secondary in NBR
M8050306	secondary in FPM

Bearing	
Part No.	M8050270

Seeger	
Part No.	M8050290

Seeger	
Part No.	M8050280

Cover	
Part No.	M8050260

Screw	
Part No.	M8050310
Torque to 398 Nm (3550 lb. in.)	

Pump seal kit		
Part No.	Parts	Type
M8050500	seals + 1 shaft seal	NBR
M8050501	seals + 2 shaft seals	NBR
M8050503	seals + 1 shaft seal	FPM (Viton®)
M8050504	seals + 2 shaft seals	FPM (Viton®)

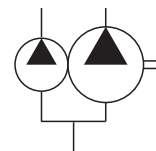
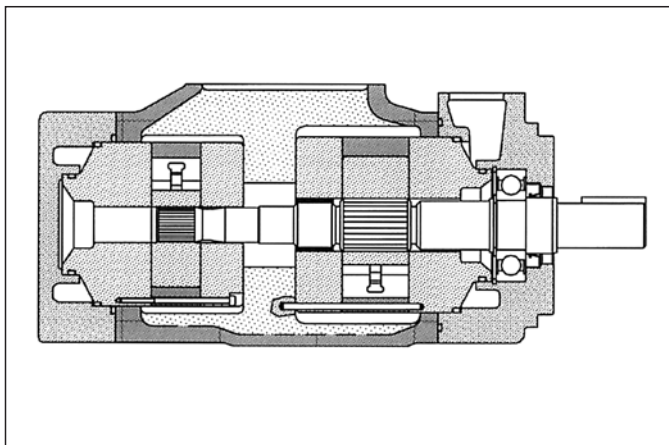

General description

Fixed displacement vane pump, hydraulically balanced, with capacity determined by the cartridges used and the speed of rotation. The pump is available in several versions with rated capacities from 55 to 134 l/min (*from 14 to 35 gpm*) at 1200 rpm and 7 bar.

Technical characteristics

Cartridge model	Geometric displacement		Rated capacity at 1200 rpm 7 bar		Rated capacity at 1500 rpm 7 bar		Maximum pressure with mineral oil		Speed range rpm	
	cm ³ /g	(in ³ /r)	l/min	(gpm)	l/min	(gpm)	bar	(psi)	min	max
shaft end										
V02-12	40,1	(2.45)	46,9	(12)	58,8	(15.5)	175	(2538)	600	1800
V02-14	45,4	(2.77)	52,7	(14)	65,7	(17.4)	175	(2538)	600	1800
V02-17	55,2	(3.37)	64,2	(17)	80,2	(21.2)	175	(2538)	600	1800
V02-19	60,1	(3.66)	71,1	(19)	88,7	(23.4)	175	(2538)	600	1800
V02-21	67,5	(4.12)	79,3	(21)	99,8	(26.4)	175	(2538)	600	1800
cover end										
V01-02	7,2	(0.44)	8,3	(2)	10,4	(2.8)	210	(3050)	600	2700
V01-05	18,0	(1.10)	20,8	(5)	26,1	(6.9)	210	(3050)	600	2700
V01-08	27,4	(1.67)	31,8	(8)	39,4	(10.4)	210	(3050)	600	2700
V01-09	30,1	(1.83)	35,1	(9)	44,1	(11.7)	210	(3050)	600	2700
V01-11	36,4	(2.22)	42,4	(11)	52,6	(13.9)	210	(3050)	600	2700
V01-12	39,5	(2.41)	46,9	(12)	58,7	(15.5)	160	(2300)	600	2700
V01-14	45,9	(2.79)	54,9	(14)	69,6	(18.4)	140	(2030)	600	2700

Hydraulic fluids: antiwear high quality mineral oils or fire resistant fluid having same lubrication capacities of the mineral oil.

Viscosity range (with mineral oil): from 13 to 860 cSt. (*13 to 54 cSt. recommended*).

Filtration: for the inlet - 149 micron abs., for the return line - 25 micron abs. or better (*with synthetic fluids: for the return line - 10 micron abs. or better*).

Inlet pressure: (*with mineral oil*): from -0,17 to +1,4 bar (*-2.5 to + 20 psi*)

Operating temperature: with mineral oil -10°C +70°C (*+30° C to +60° C recommended*), with water based fluids +15°C to +50°C.

Drive: direct and coaxial by means of a flexible coupling.

Main operating data

max pressure / hydraulic fluid

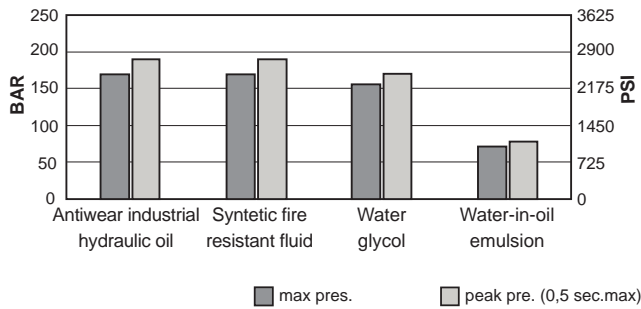

max speed / hydraulic fluid (with 0 bar in the intake pipe)

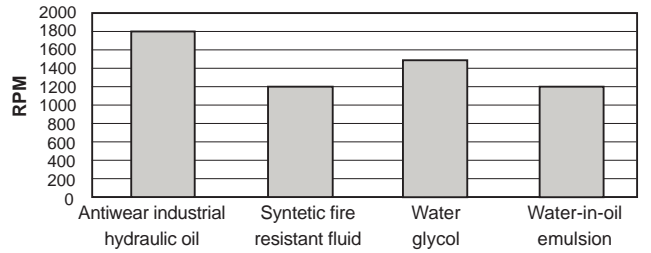

If the intake pressure is not zero bar, use the graph below to find the percentage correction factor to apply to the maximum speed

max speed / intake pipe pressure

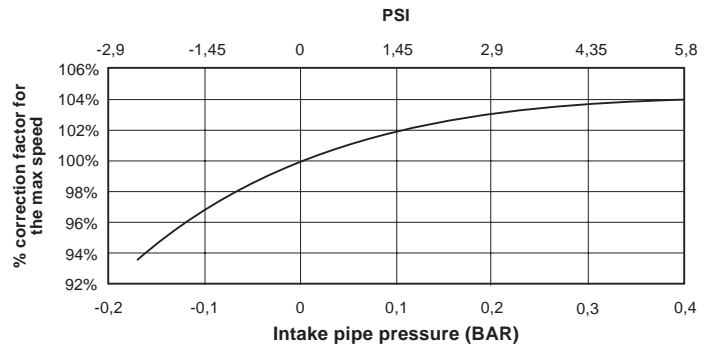

Sound level at 138 bar (2000 psi)

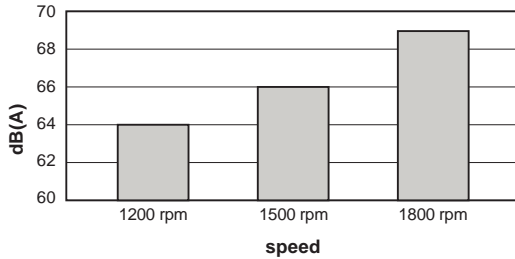

flow / pressure

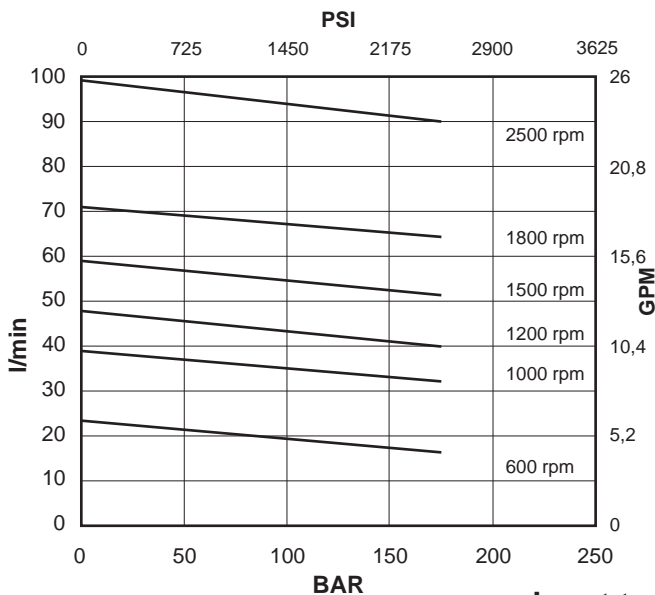

Shaft end cartridge V02-12

power / pressure

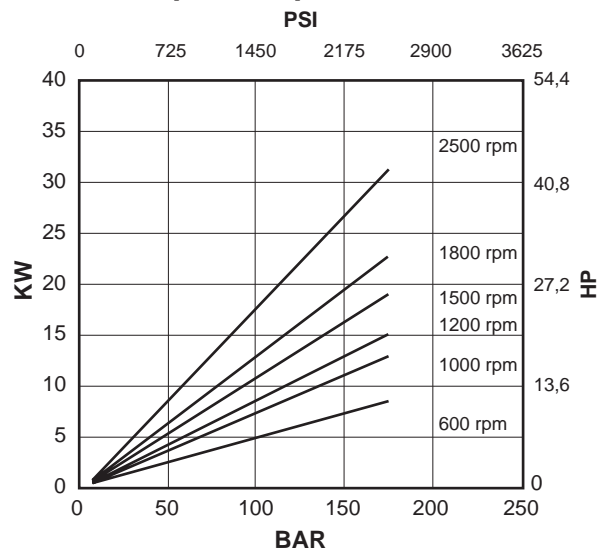

input torque / pressure

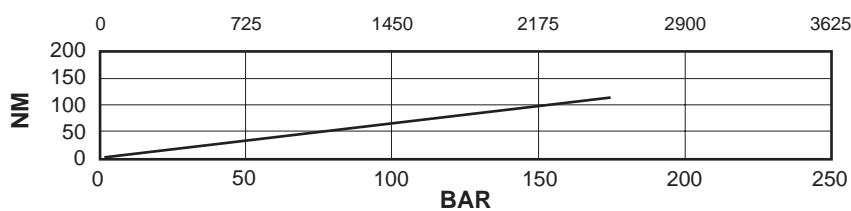

Oil viscosity: 25 c.St.(10W)
Temperature: 45°C
Inlet pressure: 0 BAR

Shaft end cartridge V02-14

flow / pressure

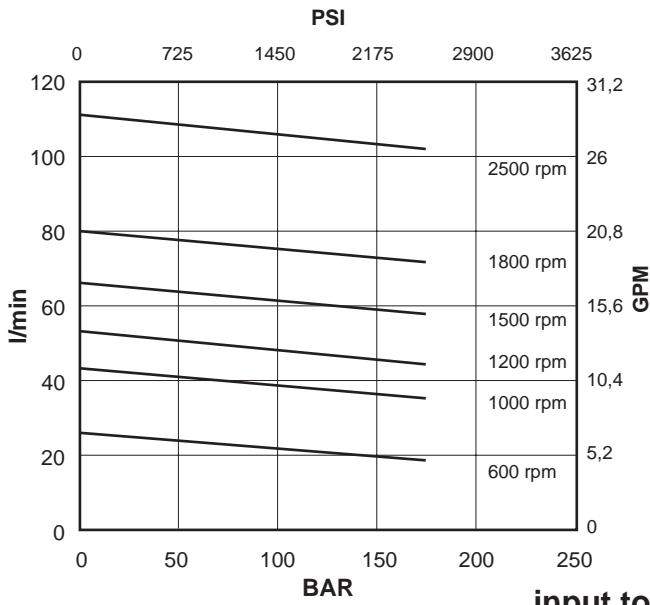

power / pressure

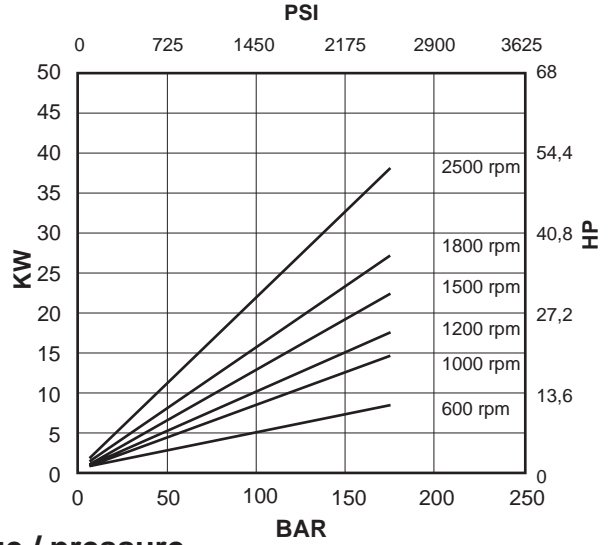

input torque / pressure

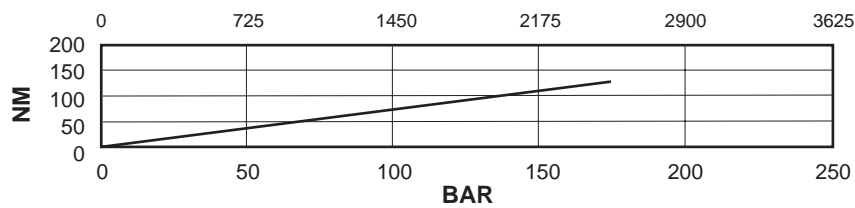

Oil viscosity: 25 c.St.(10W)
Temperature: 45°C
Inlet pressure: 0 BAR

Shaft end cartridge V02-17

flow / pressure

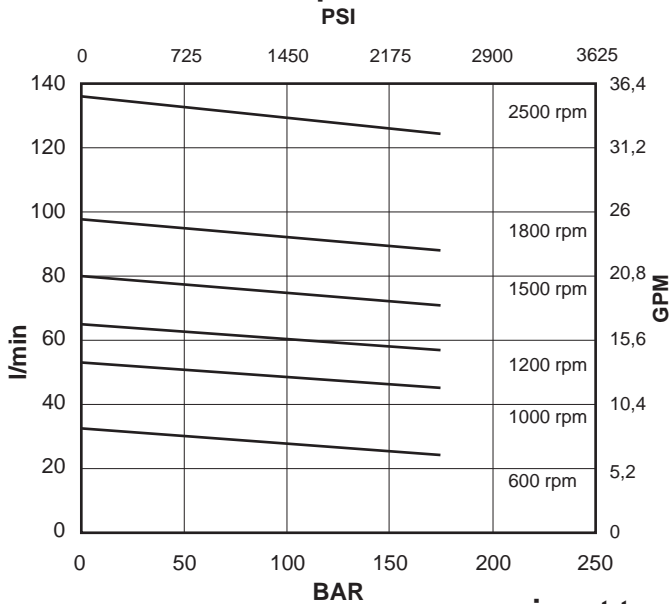

power / pressure

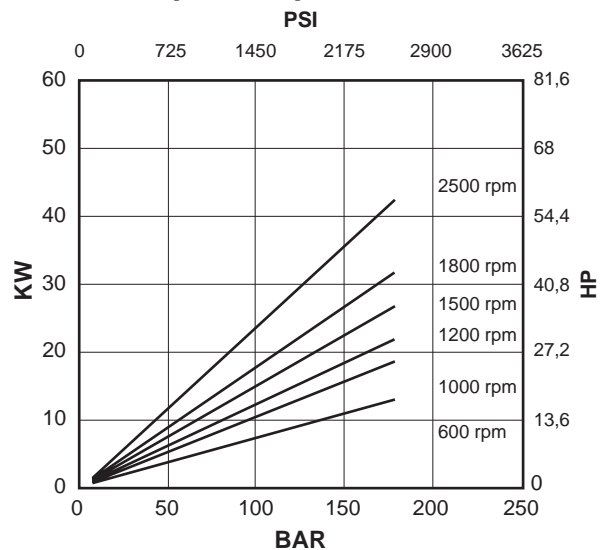

input torque / pressure

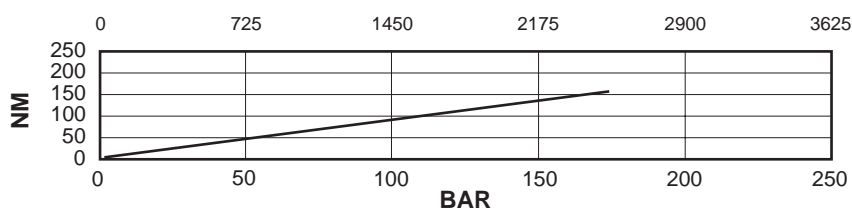

Oil viscosity: 25 c.St.(10W)
Temperature: 45°C
Inlet pressure: 0 BAR

Shaft end cartridge V02-19

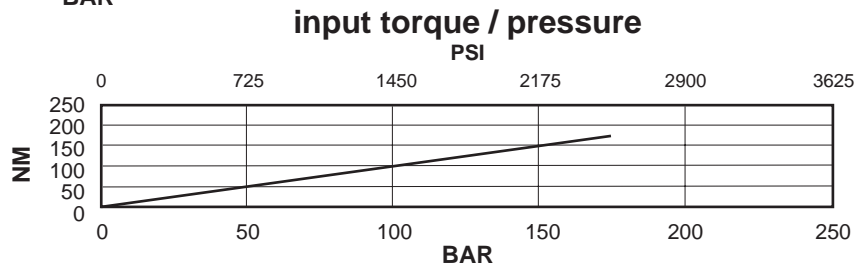
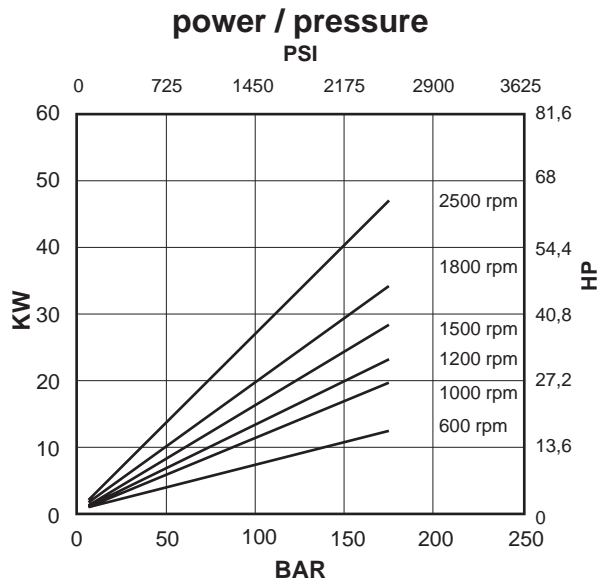
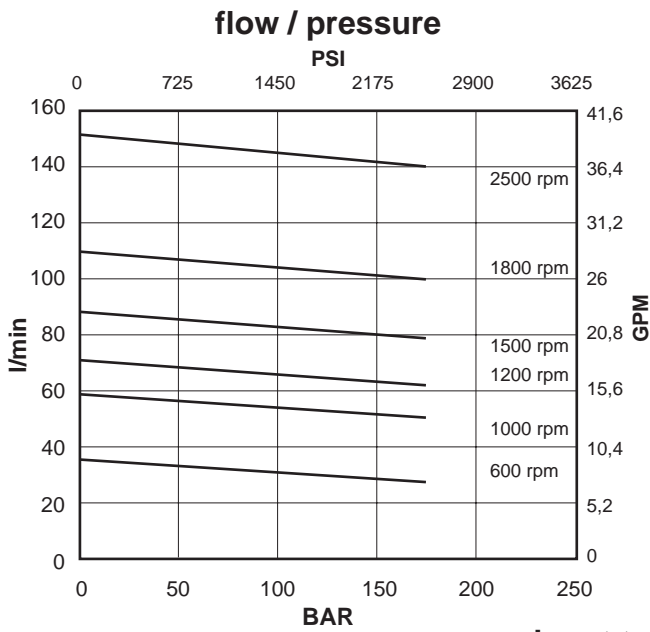

Oil viscosity: 25 c.St.(10W)
 Temperature: 45°C
 Inlet pressure: 0 BAR

Shaft end cartridge V02-21

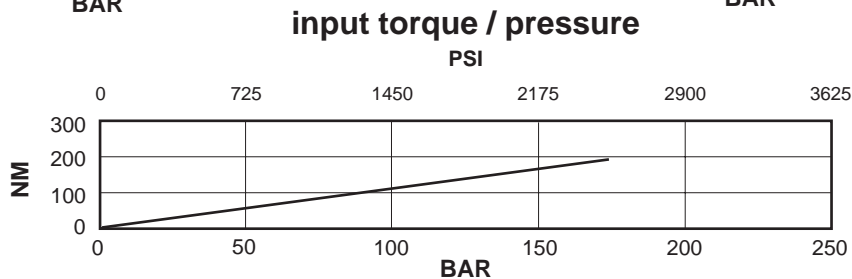
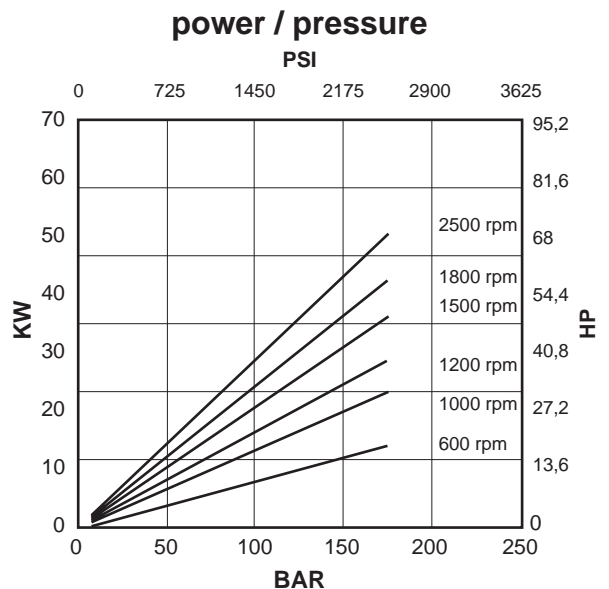
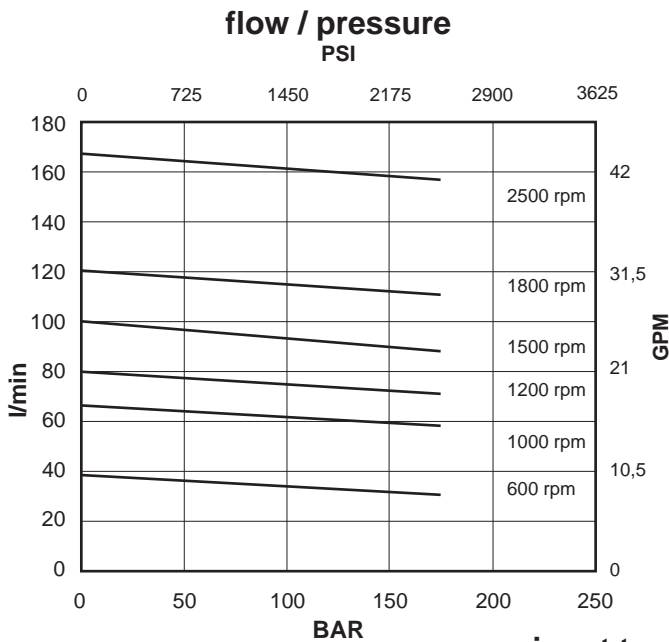

Oil viscosity: 25 c.St.(10W)
 Temperature: 45°C
 Inlet pressure: 0 BAR

Cartridge V01-02

flow / pressure

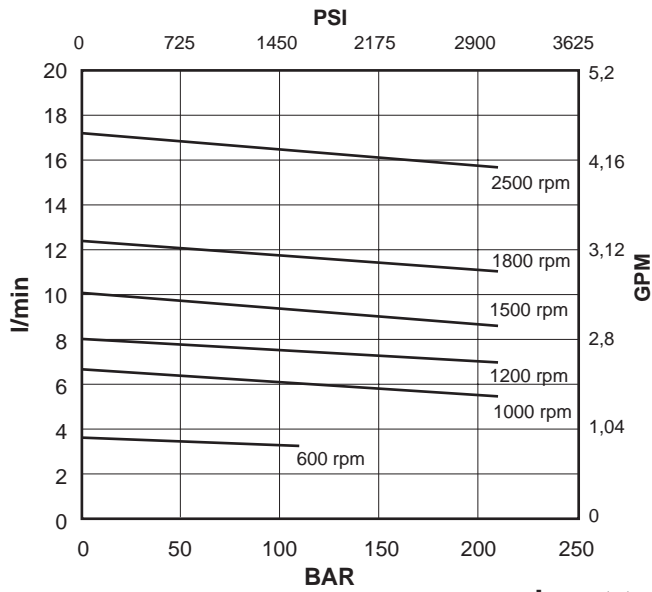

power / pressure

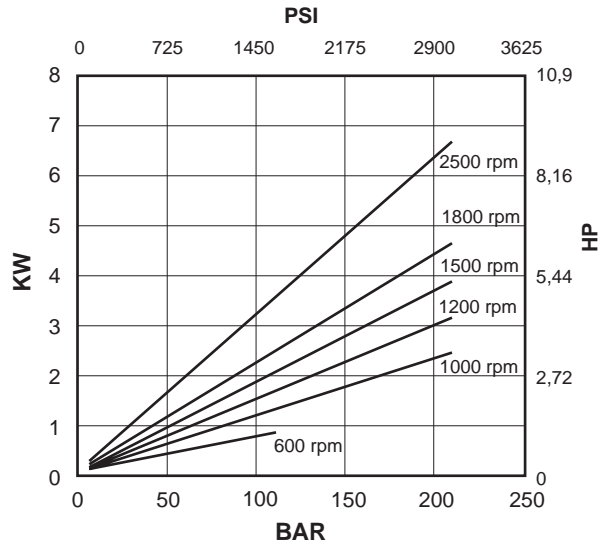

input torque / pressure

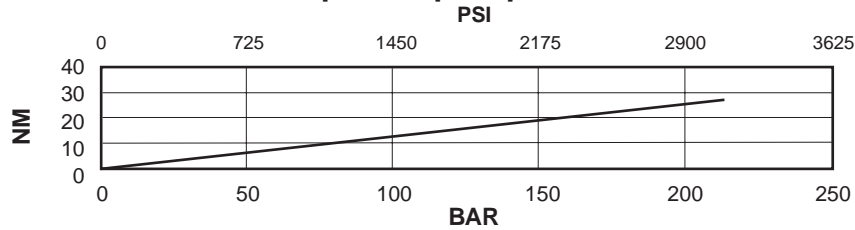

Oil viscosity: 25 c.St.(10W)
Temperature: 45°C
Inlet pressure: 0 BAR

Cartridge V01-05

flow / pressure

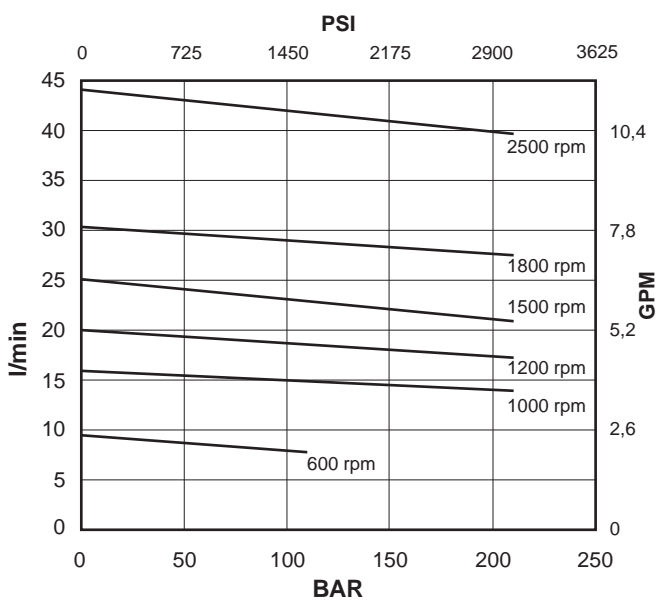

power / pressure

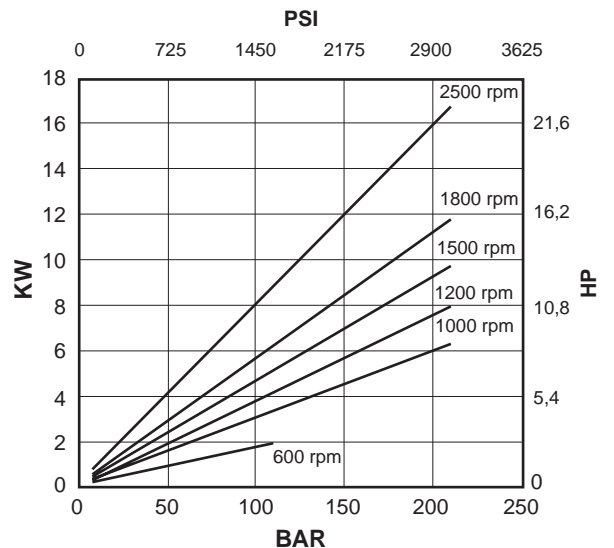

input torque / pressure

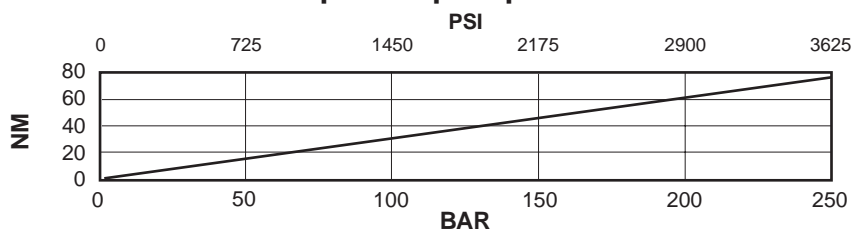

Oil viscosity: 25 c.St.(10W)
Temperature: 45°C
Inlet pressure: 0 BAR

Cartridge V01-08

flow / pressure

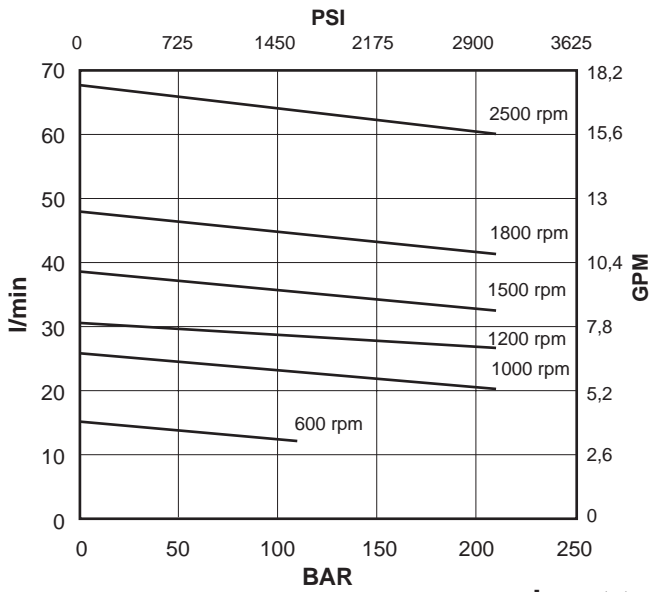

power / pressure

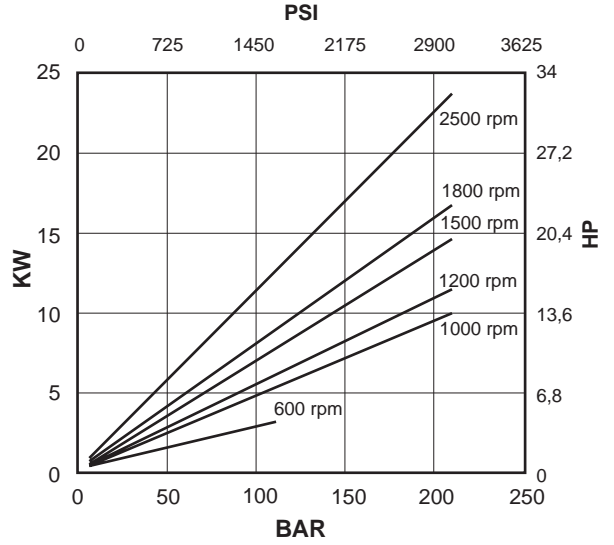

input torque / pressure

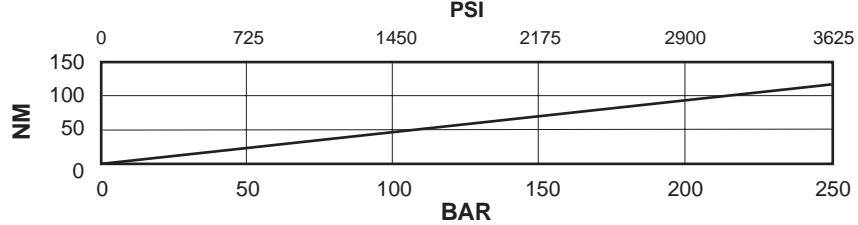

Oil viscosity: 25 c.St.(10W)
Temperature: 45°C
Inlet pressure: 0 BAR

Cartridge V01-09

flow / pressure

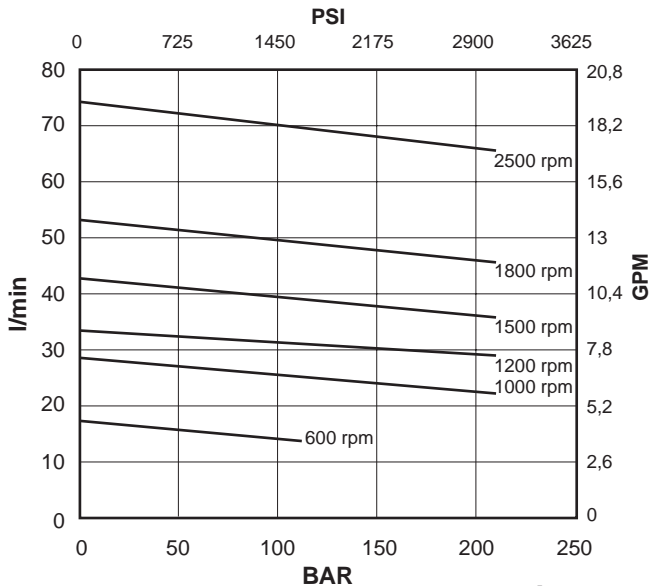

power / pressure

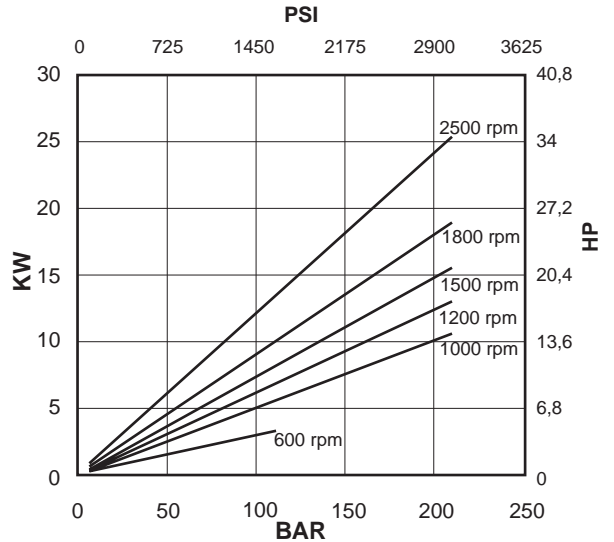

input torque / pressure

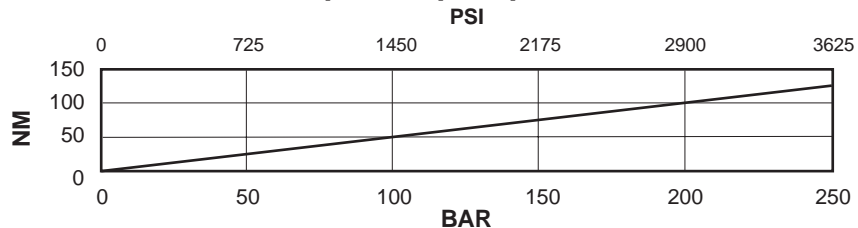

Oil viscosity: 25 c.St.(10W)
Temperature: 45°C
Inlet pressure: 0 BAR

Cover end cartridge V01-11

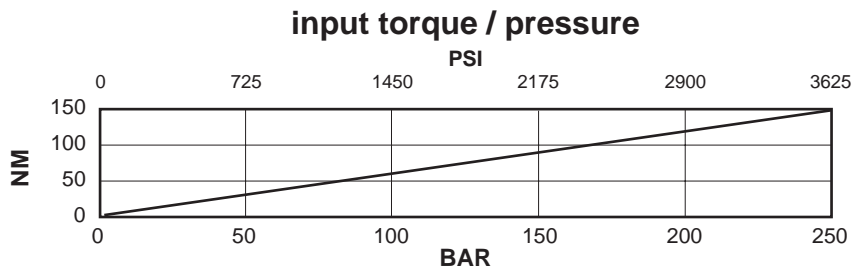
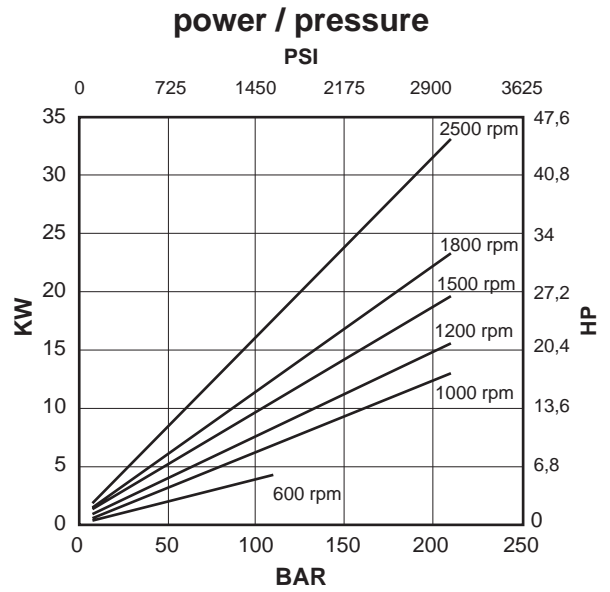
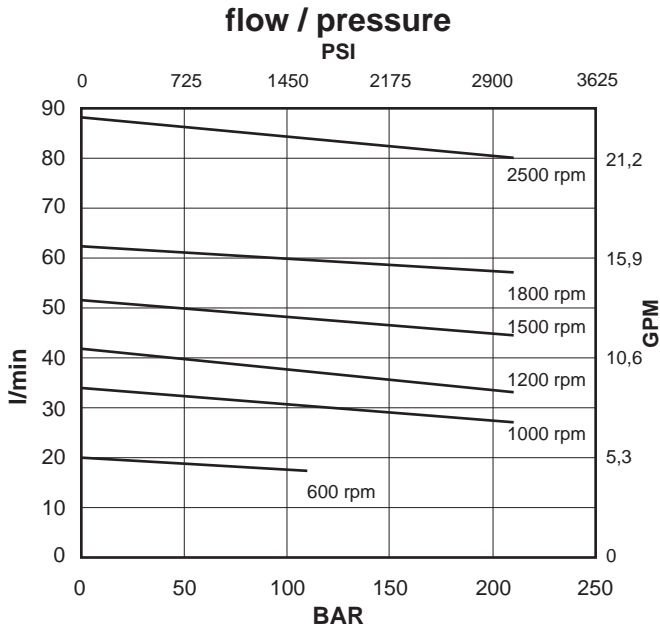

Oil viscosity: 25 c.St.(10W)
 Temperature: 45°C
 Inlet pressure: 0 BAR

Cover end cartridge V01-12

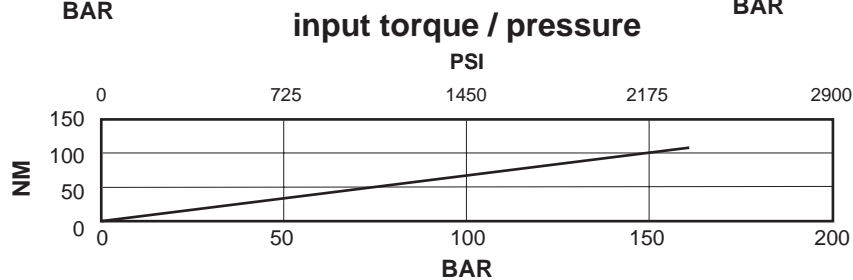
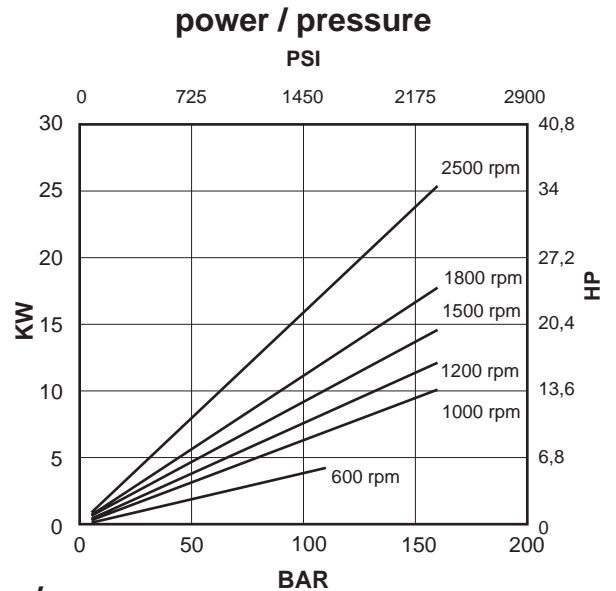
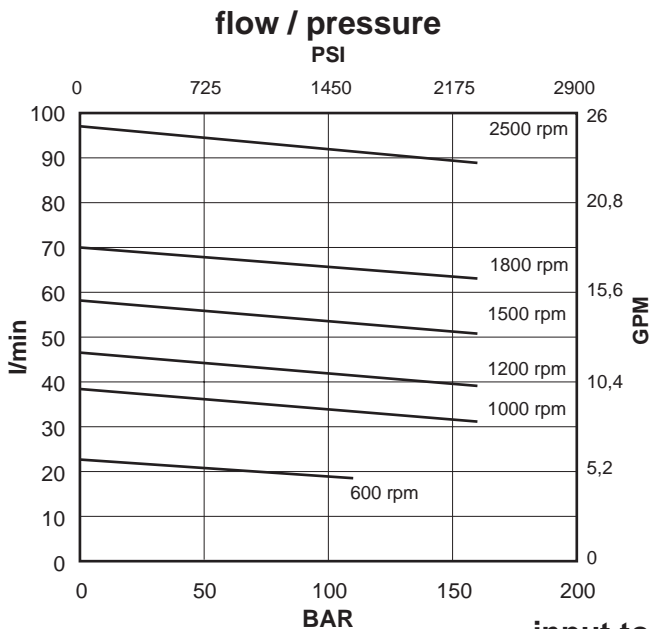

Oil viscosity: 25 c.St.(10W)
 Temperature: 45°C
 Inlet pressure: 0 BAR

Cover end cartridge V01-14

flow / pressure

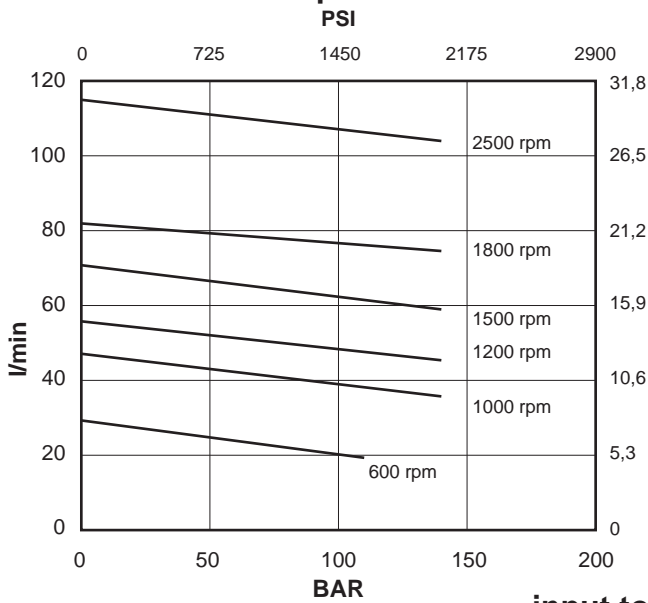

power / pressure

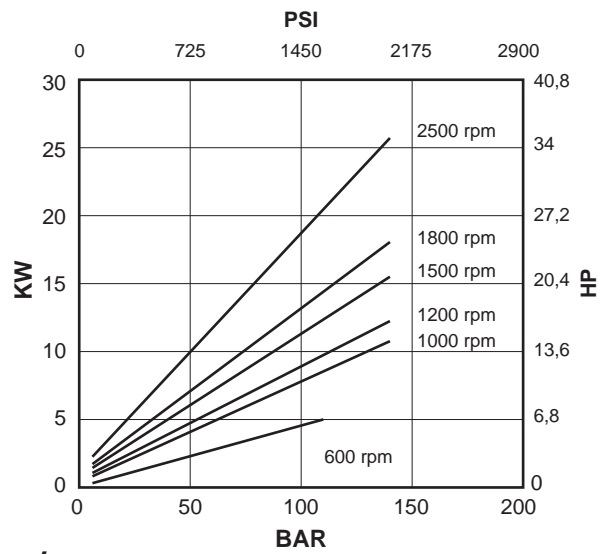

input torque / pressure

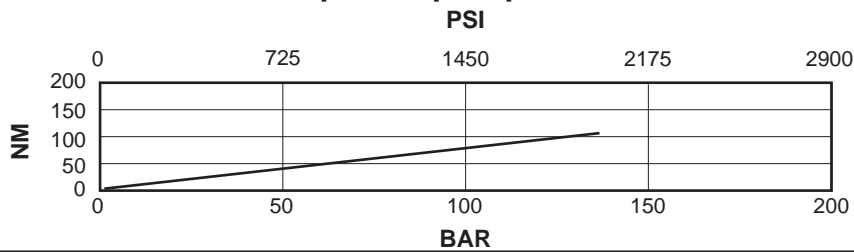

Oil viscosity: 25 c.St.(10W)
Temperature: 45°C
Inlet pressure: 0 BAR

Installation dimensions mm (inches)

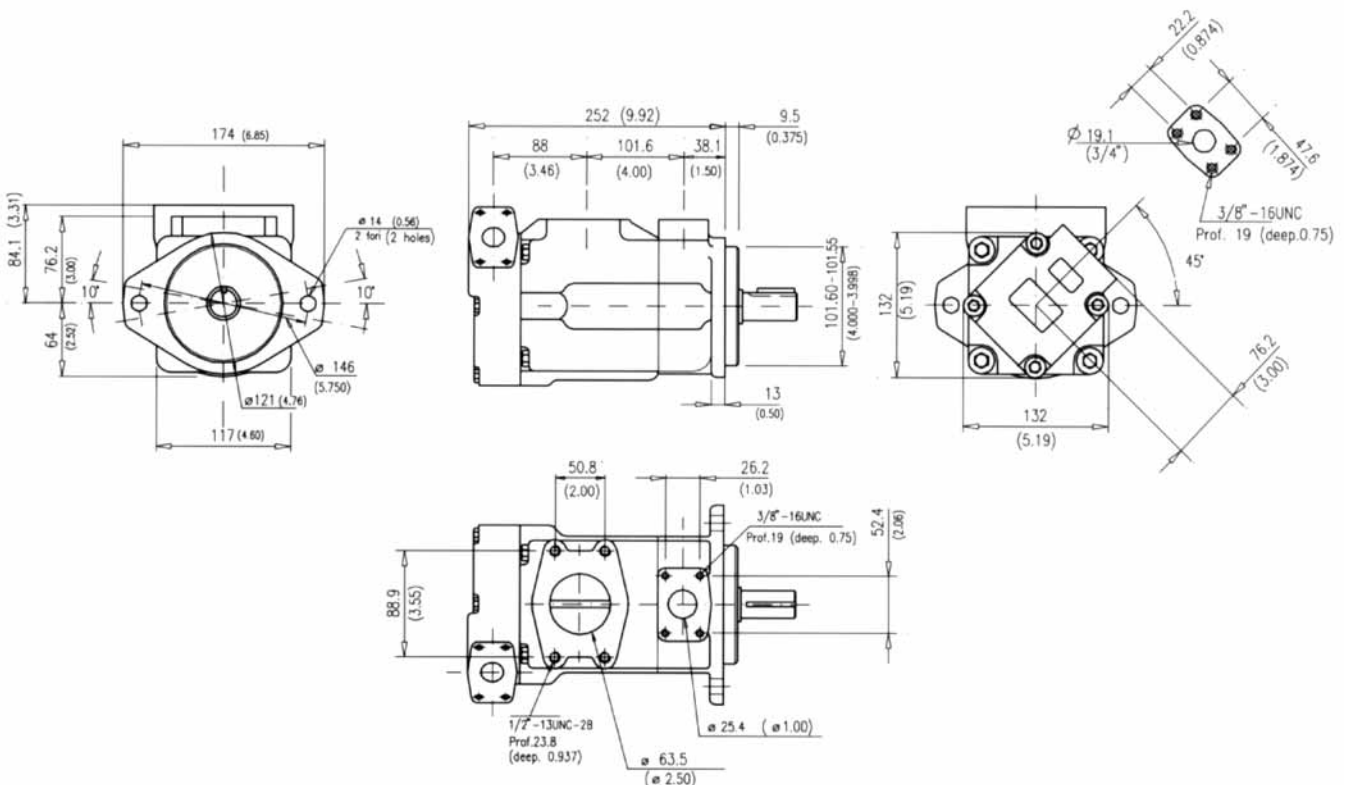

Approx. weight: 20,5 Kg. (45 lbs.)

Model code breakdown

BV	21	G	**	**	*	*	**	(L)	*	(A)	
Pump series		Design								Mounting (omit if not required)	
Pump type											
Cartridge types											
-shaft end		12	14	17	19	21					
-cover end		02	05	08	09	11	12	14			
Body outlet port positions (outlet viewed from cover end)											
A = Outlet opposite end											
B = Outlet 90° CCW from inlet											
C = Outlet in line with inlet											
D = Outlet 90° CW from inlet											
Cover outlet port positions (outlet viewed from cover end)											
A = Outlet 135° CCW from inlet											
B = Outlet 45° CCW from inlet											
C = Outlet 45° CW from inlet											
D = Outlet 135° CW from inlet											
Shaft end options											
01 = Straight with key (standard), 11 = Splined											
86 = Heavy duty straight keyed, 90 = Splined SAE B											
Seals (omit with standard seals and one shaft-seal in NBR)											
V = seals and shaft-seal in FPM (Viton®)											
D = standard seals and double shaft-seals in NBR											
F = seals and double shaft-seals in FPM (Viton®)											
Rotation (viewed from shaft end)											
L = left hand rotation CCW (omit if CW)											

Shaft options mm (inches)

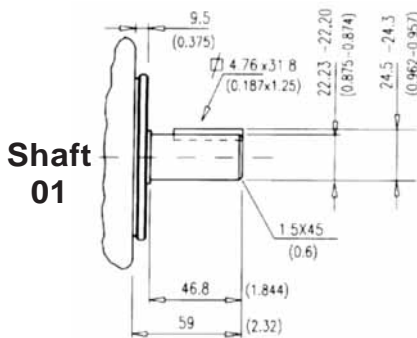

max. torque capability : 320Nm (2800 lb.in.)

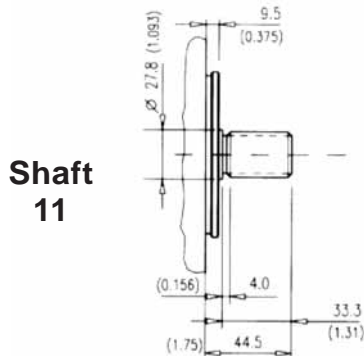

max. torque capability : 320Nm (2800 lb.in.)

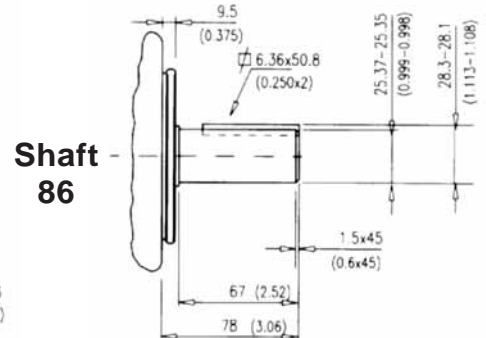

max torque capability: 400 Nm (3560 lb. in.)

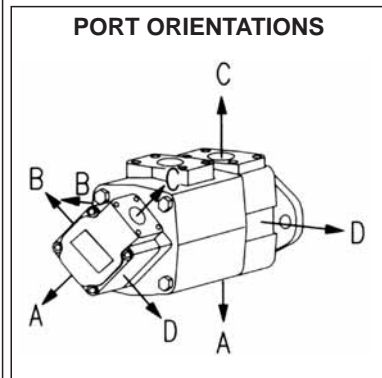

Spline data
(shaft 11 and shaft 90)

Spline	Involute side fit (ASA B5.15)	
Pressure angle	30°	
No. of teeth	13	
Pitch	16/32	
Major dia.	22.00 - 21.90	(0.866 - 0.862)
Pitch dia.	20.638	(0.8125)
Minor dia.	18.63 - 18.35	(0.733 - 0.722)
Wildhaber	11.67 - 11.70	(0.459 - 0.461)

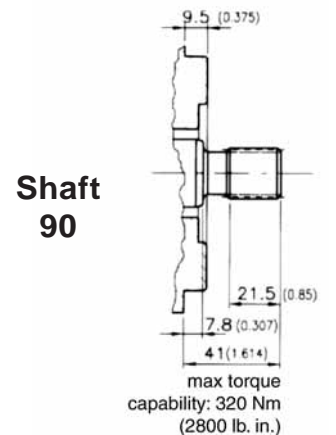

max torque capability: 320 Nm (2800 lb. in.)

Id. codes of pump components

cover end		Cartridges				Pump rotation
		shaft end				
Series	Model	Part No.	Series	Model	Part No.	
V01	02	V0102000	V02	12	V0212030	right hand
	05	V0105010		14	V0214070	
	08	V0108030		17	V0217110	
	09	V0109050		19	V0219150	
	11	V0111070		21	V0221190	
	12	V0112090				
	14	V0114110				
V01	02	V0102005	V02	12	V0212040	left hand
	05	V0105020		14	V0214080	
	08	V0108040		17	V0217120	
	09	V0109060		19	V0219160	
	11	V0111080		21	V0221200	
	12	V0112100				
	14	V0114120				

Shaft kit		Shaft		Key		Body	
Model	Part No.	Model	Part No.	Part No.	Part No.	Part No.	Part No.
01	M8210601	01	K2101000	M8010100	M8020010		
11	M8210611	11	K2111000	-			
86	M8210686	86	K2186000	M8028600			
90	M8210690	90	K2190000	-			

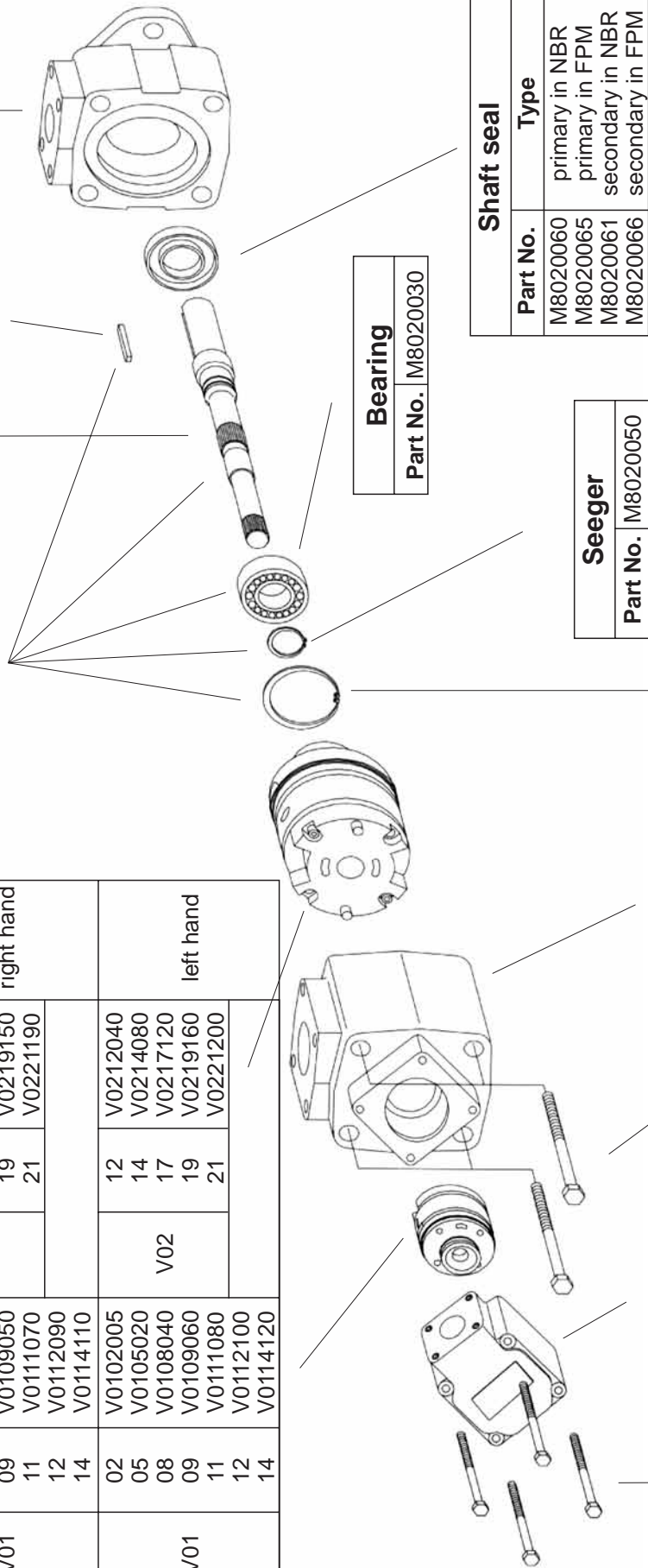

Shaft seal	
Part No.	Type
M8020060	primary in NBR
M8020065	primary in FPM
M8020061	secondary in NBR
M8020066	secondary in FPM

Bearing	
Part No.	
M8020030	

Seeger	
Part No.	
M8020050	

Inlet body	
Part No.	
M8020110	

Cover	
Part No.	
M8020120	

Screw	
Part No.	
M8020130	
Torque to 102 Nm (910 lb. in.)	

Screw	
Part No.	
M8020420	
Torque to 70 Nm (624 lb. in.)	

Pump seal kit		
Part No.	Parts	Type
M8210500	seals + 1 shaft seal	NBR
M8210501	seals + 2 shaft seals	NBR
M8210503	seals + 1 shaft seal	FPM (Viton®)
M8210504	seals + 2 shaft seals	FPM (Viton®)

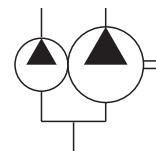
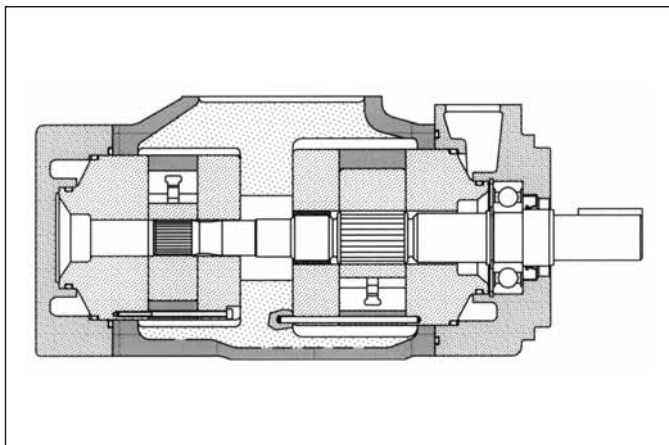

General description

Fixed displacement vane pump, hydraulically balanced, with capacity determined by the cartridges used and the speed of rotation. The pump is available in several versions with rated capacities from 87 to 195 l/min (from 23 to 52 gpm) at 1200 rpm and 7 bar.

Technical characteristics

Cartridge model	Geometric displacement		Rated capacity at 1200 rpm 7 bar		Rated capacity at 1500 rpm 7 bar		Maximum pressure with mineral oil		Speed range rpm	
	cm ³ /g	(in ³ /r)	l/min	(gpm)	l/min	(gpm)	bar	(psi)	min	max
shaft end										
V04-21	69,0	(4.2)	79,5	(21)	101,4	(26.8)	175	(2538)	600	1800
V04-25	81,6	(5)	94,0	(25)	120,1	(31.7)	175	(2538)	600	1800
V04-30	97,7	(6)	113,8	(30)	141,2	(37.3)	175	(2538)	600	1800
V04-35	112,7	(6.9)	131,6	(35)	167,2	(44.1)	175	(2538)	600	1800
V04-38	121,6	(7.4)	139,9	(38)	177,3	(46.8)	175	(2538)	600	1800
cover end										
V01-02	7,2	(0.44)	8,3	(2)	10,4	(2.8)	210	(3050)	600	2700
V01-05	18,0	(1.10)	20,8	(5)	26,1	(6.9)	210	(3050)	600	2700
V01-08	27,4	(1.67)	31,8	(8)	39,4	(10.4)	210	(3050)	600	2700
V01-09	30,1	(1.83)	35,1	(9)	44,1	(11.7)	210	(3050)	600	2700
V01-11	36,4	(2.22)	42,4	(11)	52,6	(13.9)	210	(3050)	600	2700
V01-12	39,5	(2.41)	46,9	(12)	58,7	(15.5)	160	(2300)	600	2700
V01-14	45,9	(2.79)	54,9	(14)	69,6	(18.4)	140	(2030)	600	2700

Hydraulic fluids: antiwear high quality mineral oils or fire resistant fluid having same lubrication capacities of the mineral oil.

Viscosity range (with mineral oil): from 13 to 860 cSt. (13 to 54 cSt. recommended).

Filtration: for the inlet - 149 micron abs., for the return line - 25 micron abs. or better (with synthetic fluids: for the return line - 10 micron abs. or better).

Inlet pressure: (with mineral oil): from -0,17 to +1,4 bar (-2.5 to + 20 psi)

Operating temperature: with mineral oil -10°C +70°C (+30°C to +60°C recommended), with water based fluids +15°C to +50°C.

Drive: direct and coaxial by means of a flexible coupling.

Main operating data

max pressure / hydraulic fluid

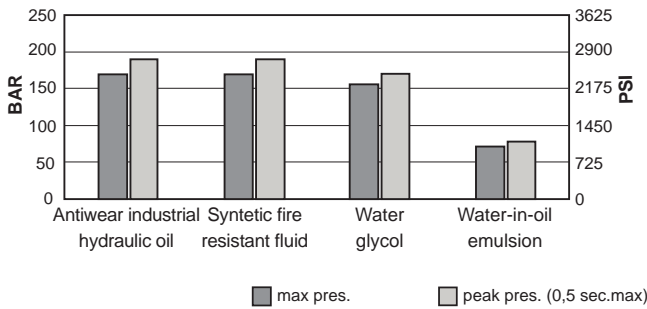

max speed / hydraulic fluid (with 0 bar in the intake pipe)

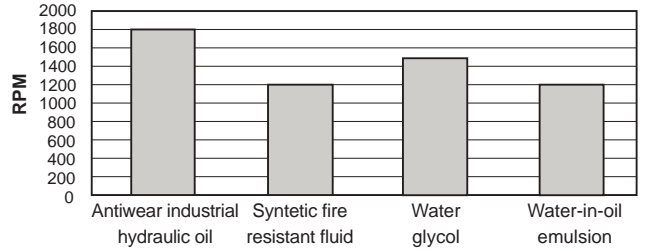

If the intake pressure is not zero bar, use the graph below to find the percentage correction factor to apply to the maximum speed

max speed / intake pipe pressure

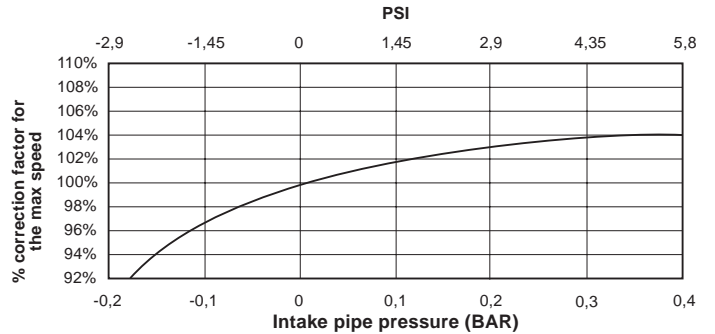

Sound level at 138 bar (2000 psi)

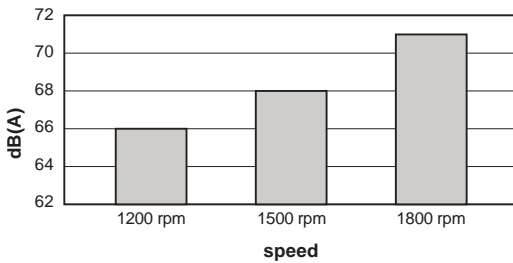

Shaft end cartridge V04-21

flow / pressure

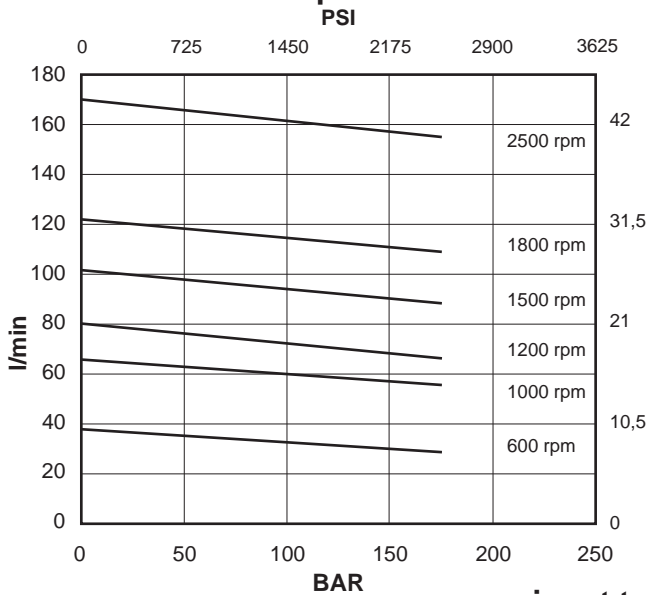

power / pressure

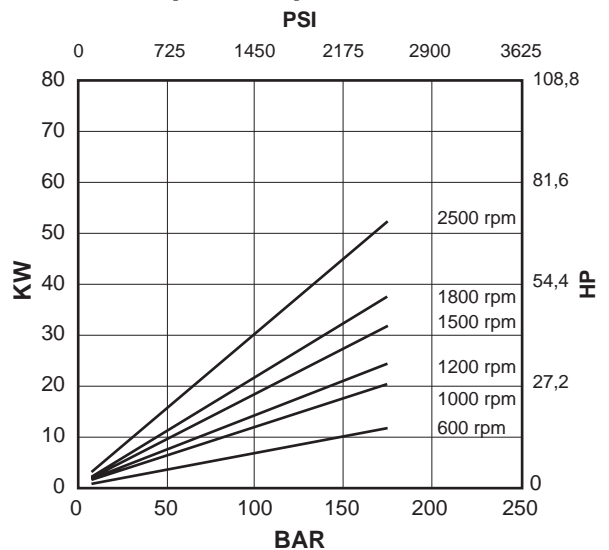

input torque / pressure

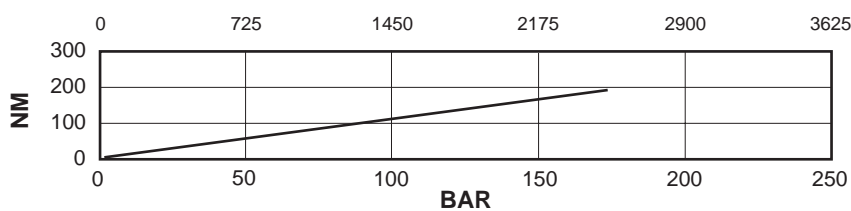

Oil viscosity: 25 c.St.(10W)
Temperature: 45°C
Inlet pressure: 0 BAR

Shaft end cartridge V04-25

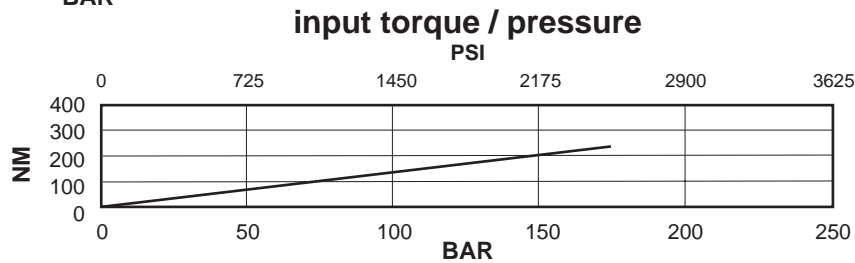
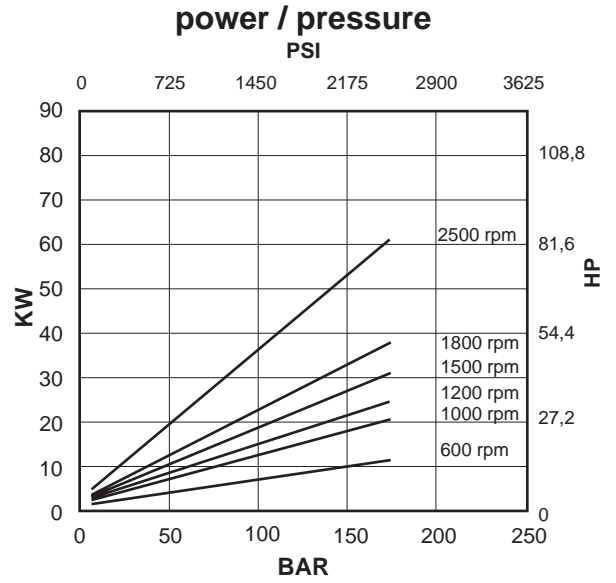
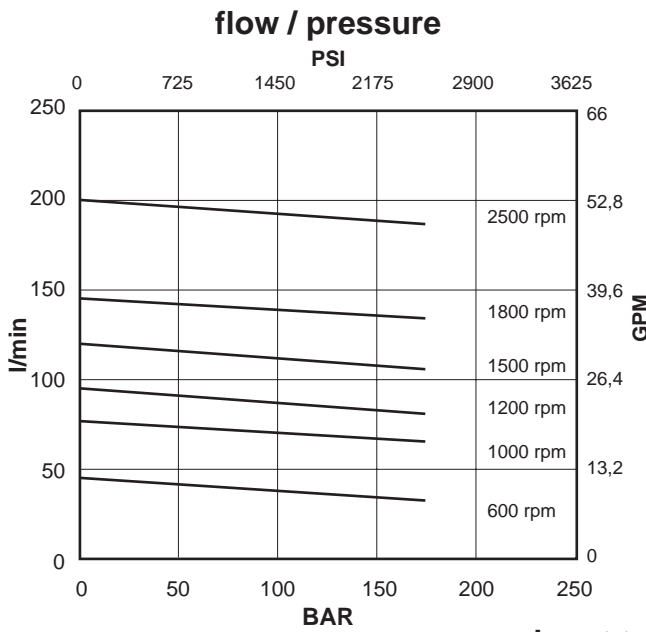

Oil viscosity: 25 c.St.(10W)
 Temperature: 45°C
 Inlet pressure: 0 BAR

Shaft end cartridge V04-30

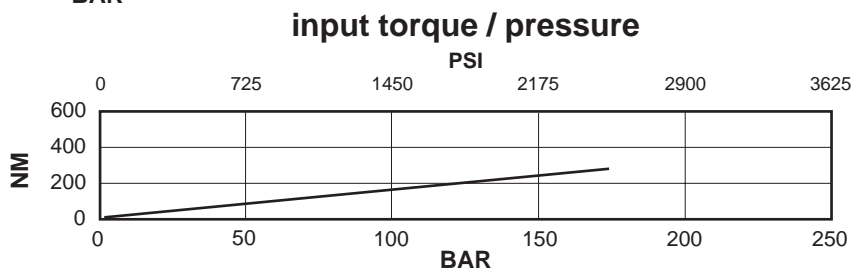
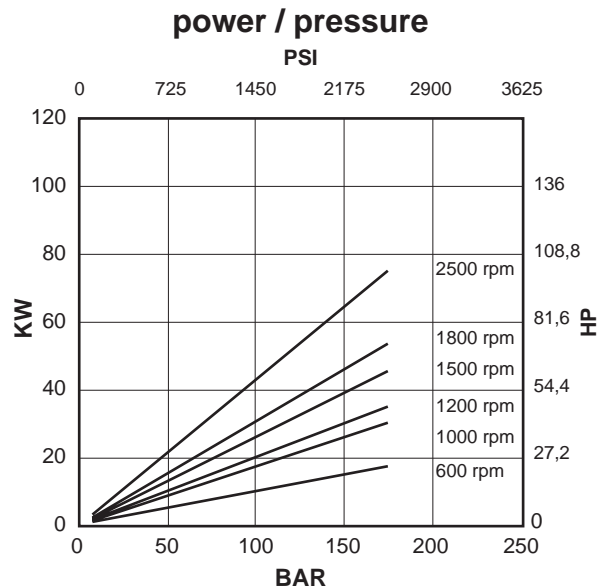
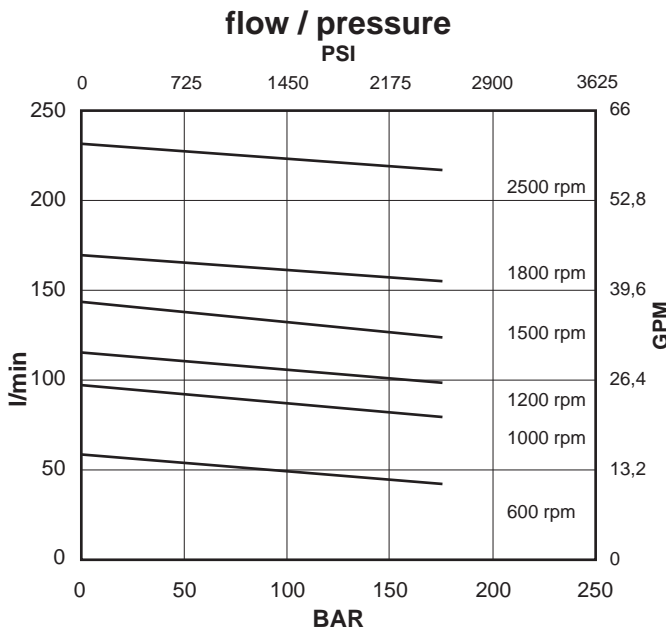

Oil viscosity: 25 c.St.(10W)
 Temperature: 45°C
 Inlet pressure: 0 BAR

Shaft end cartridge V04-35

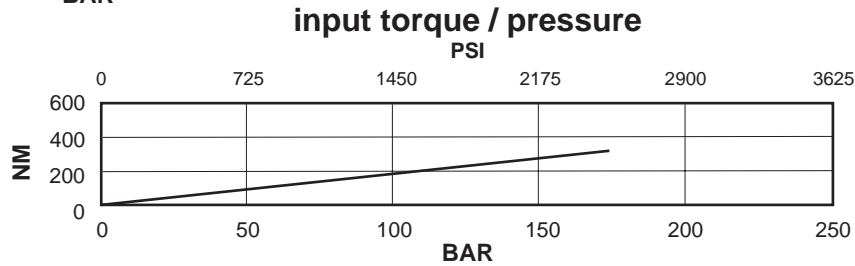
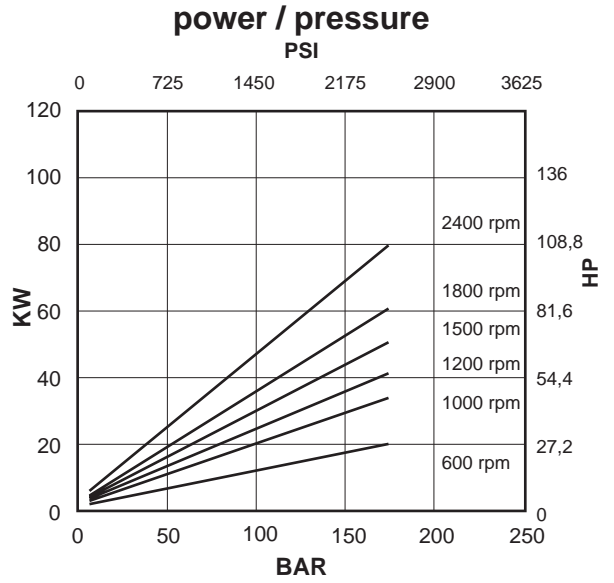
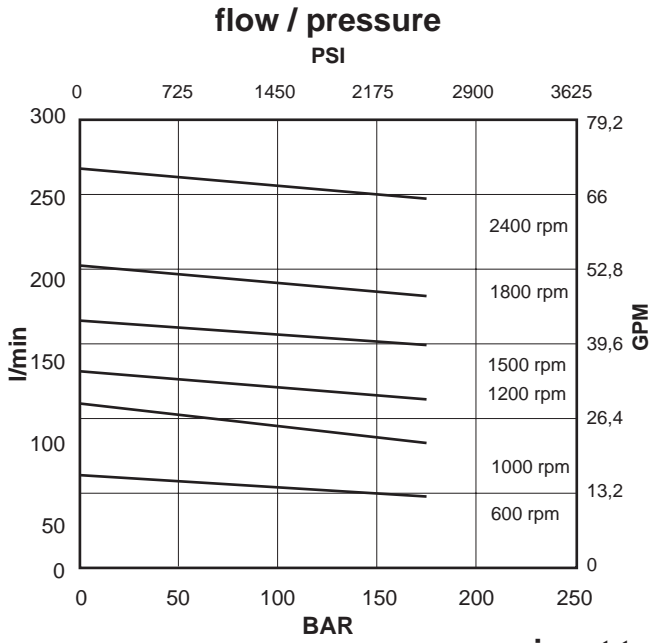

Oil viscosity: 25 c.St.(10W)
Temperature: 45°C
Inlet pressure: 0 BAR

Shaft end cartridge V04-38

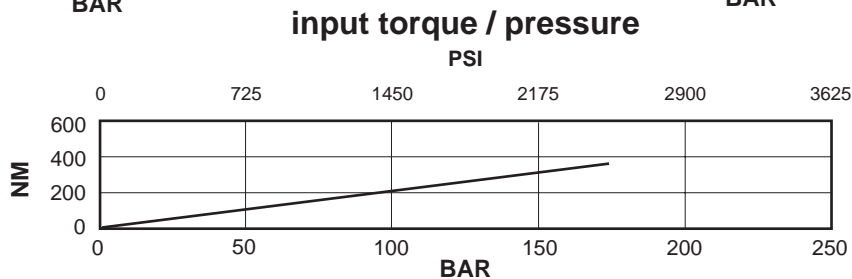
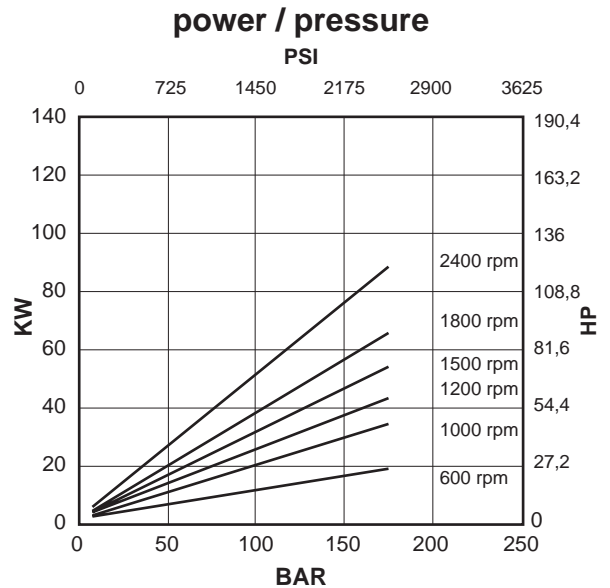
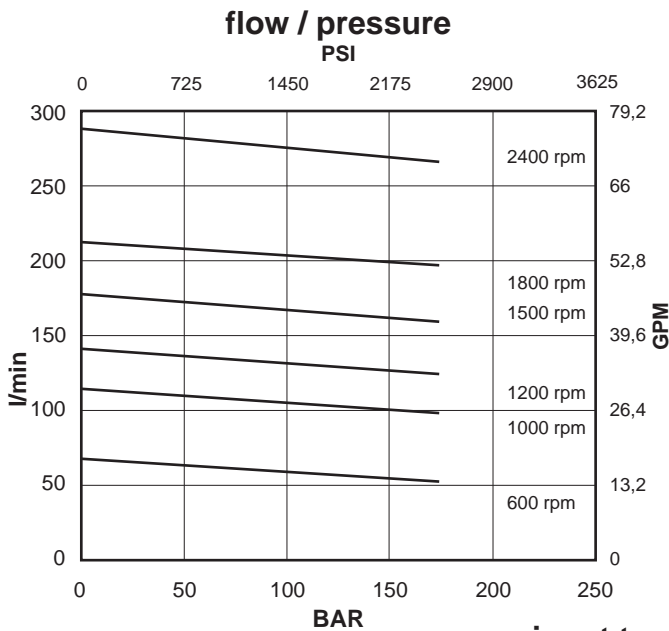

Oil viscosity: 25 c.St.(10W)
Temperature: 45°C
Inlet pressure: 0 BAR

Cartridge V01-02

flow / pressure

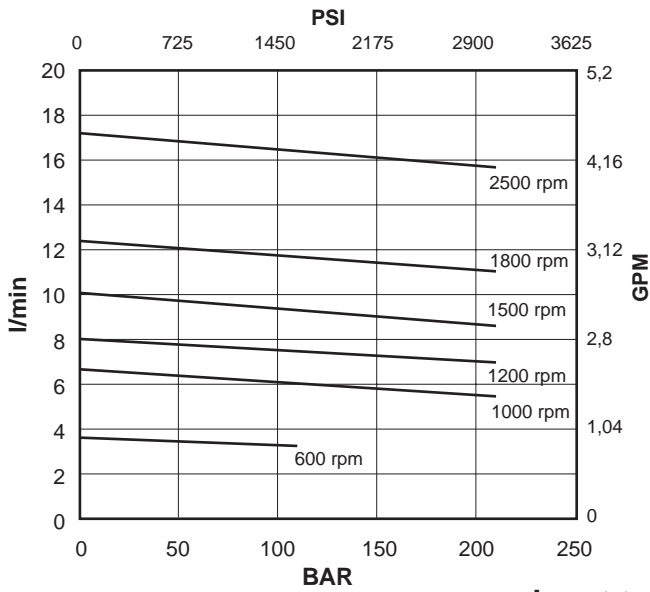

power / pressure

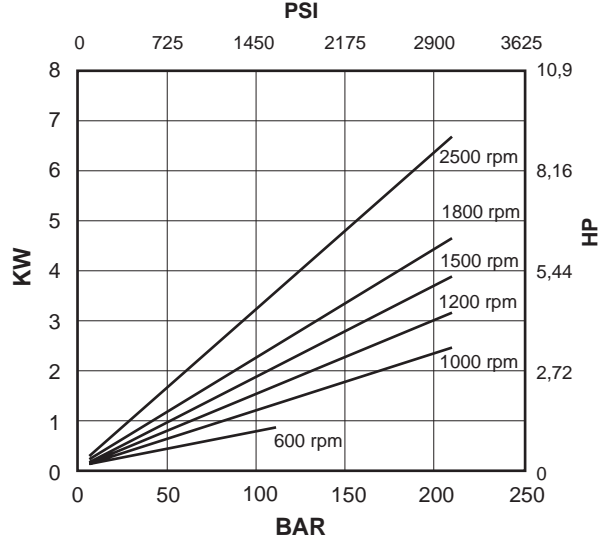

input torque / pressure

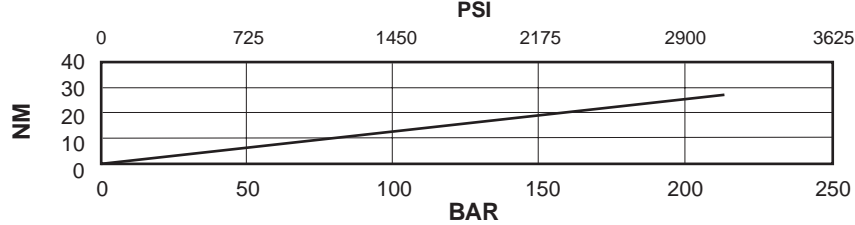

Oil viscosity: 25 c.St.(10W)
Temperature: 45°C
Inlet pressure: 0 BAR

Cartridge V01-05

flow / pressure

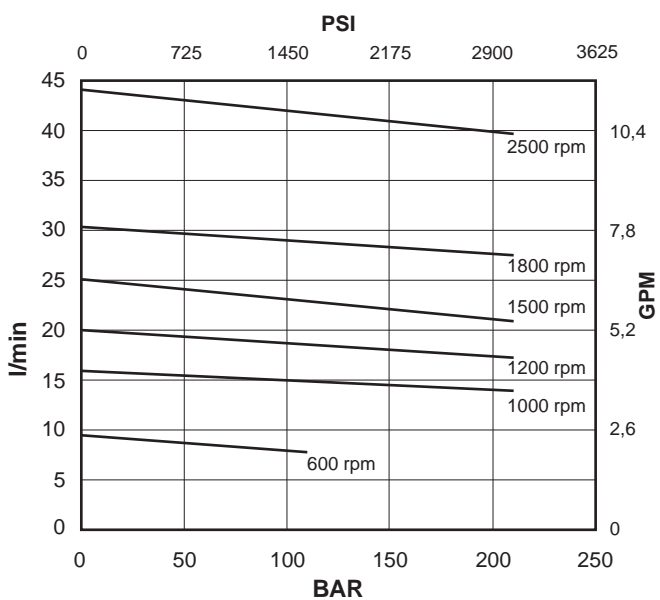

power / pressure

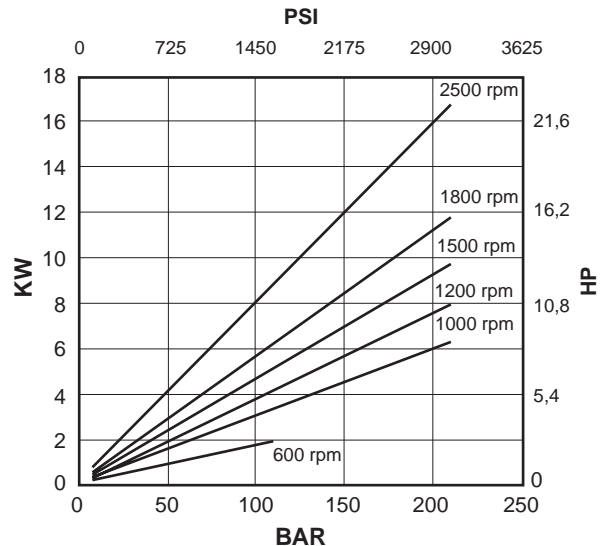

input torque / pressure

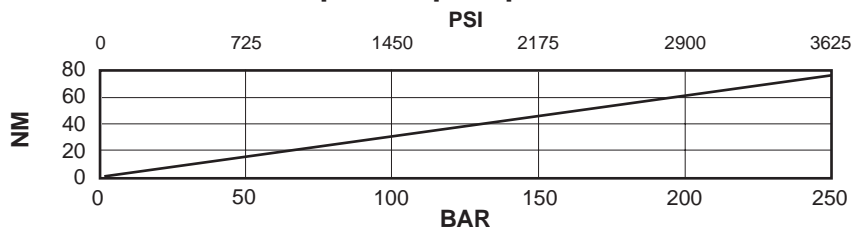

Oil viscosity: 25 c.St.(10W)
Temperature: 45°C
Inlet pressure: 0 BAR

Cartridge V01-08

flow / pressure

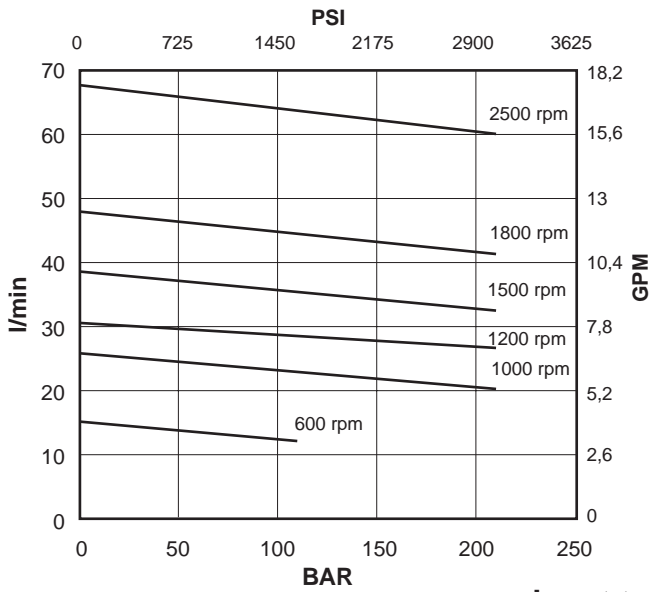

power / pressure

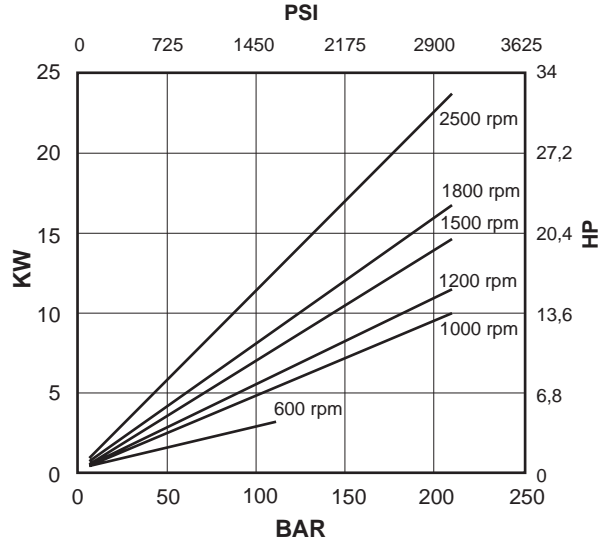

input torque / pressure

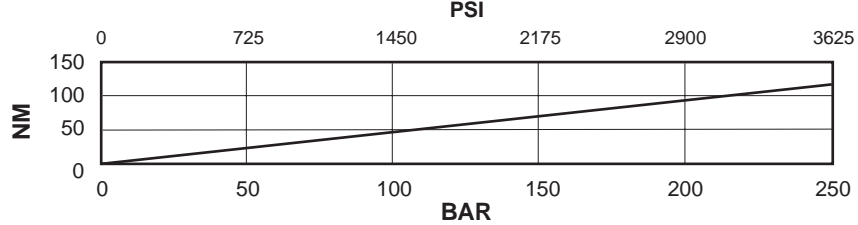

Oil viscosity: 25 c.St.(10W)
Temperature: 45°C
Inlet pressure: 0 BAR

Cartridge V01-09

flow / pressure

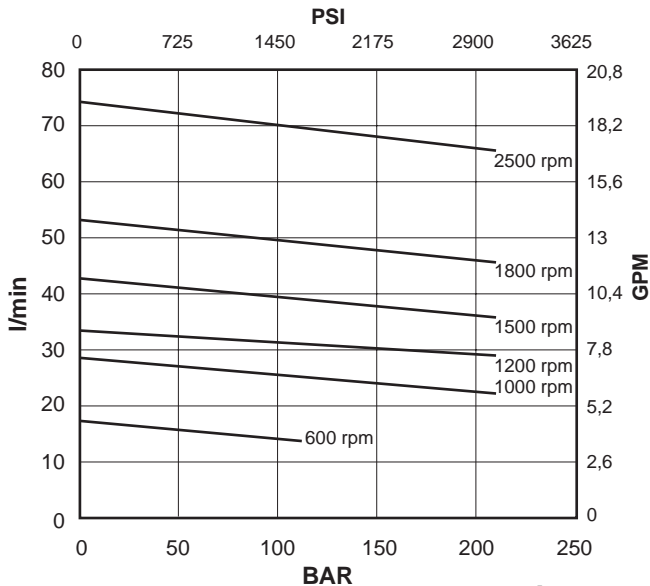

power / pressure

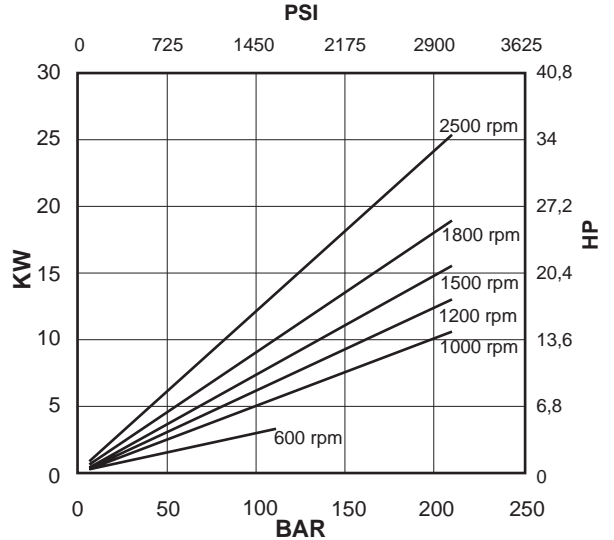

input torque / pressure

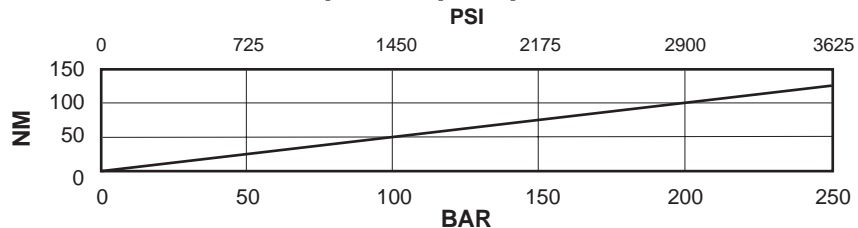

Oil viscosity: 25 c.St.(10W)
Temperature: 45°C
Inlet pressure: 0 BAR

Cover end cartridge V01-11

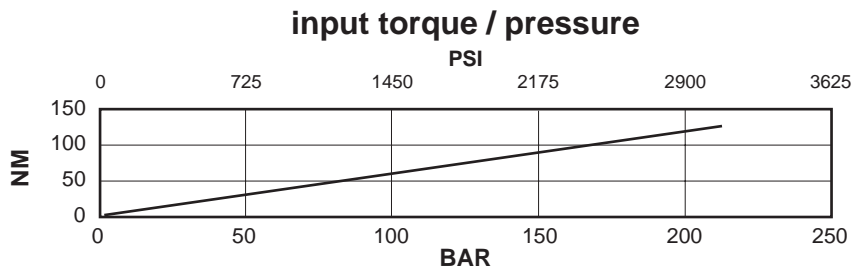
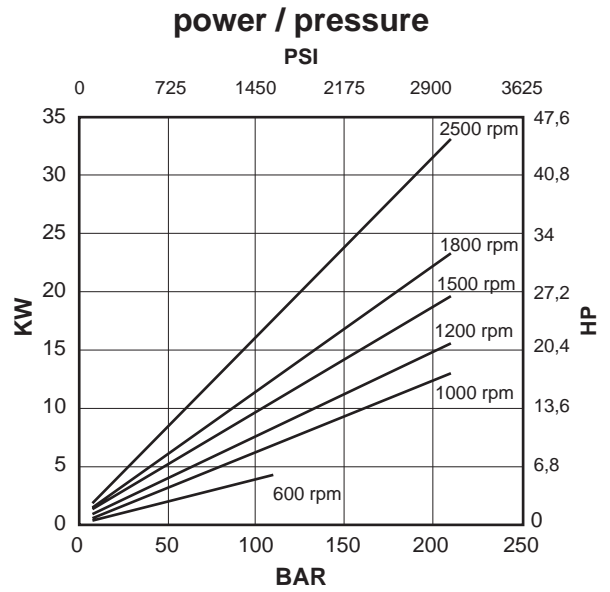
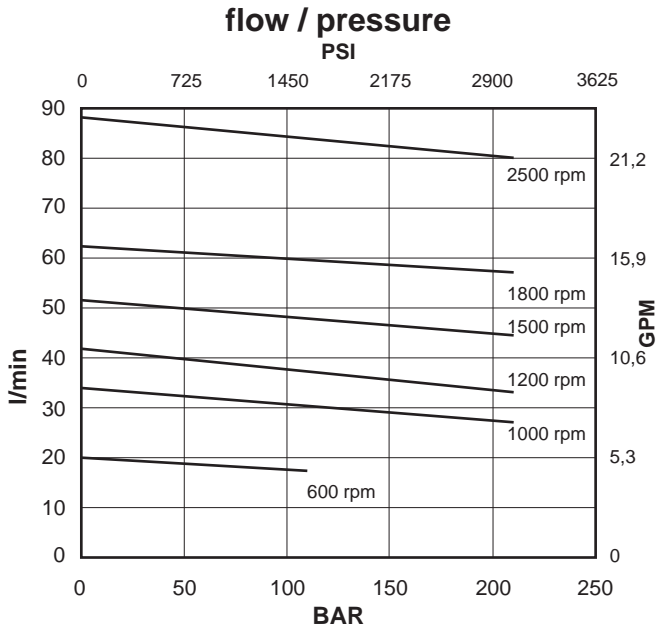

Oil viscosity: 25 c.St.(10W)
 Temperature: 45°C
 Inlet pressure: 0 BAR

Cover end cartridge V01-12

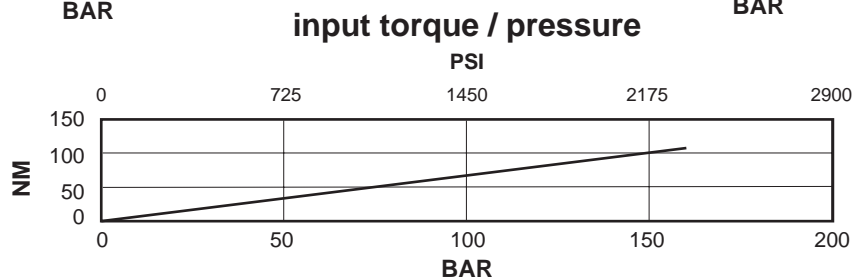
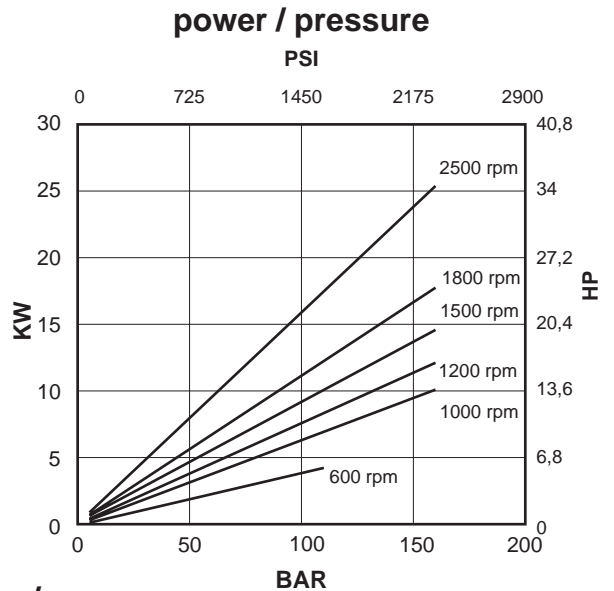
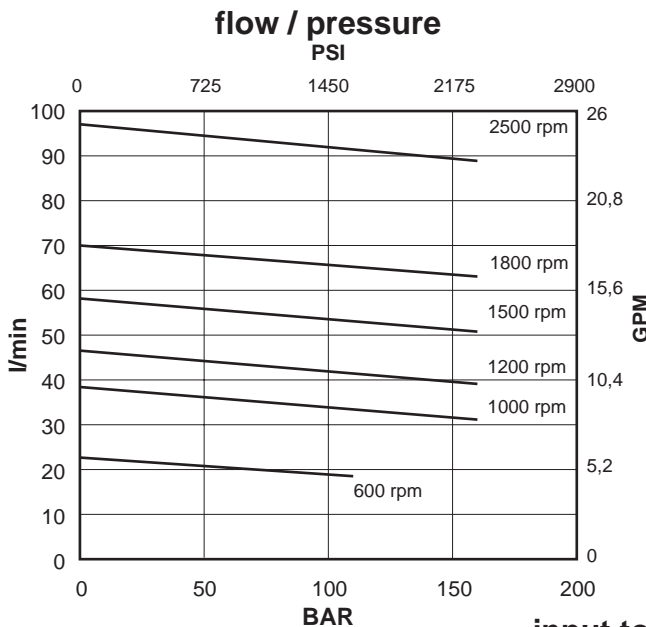

Oil viscosity: 25 c.St.(10W)
 Temperature: 45°C
 Inlet pressure: 0 BAR

Cover end cartridge V01-14

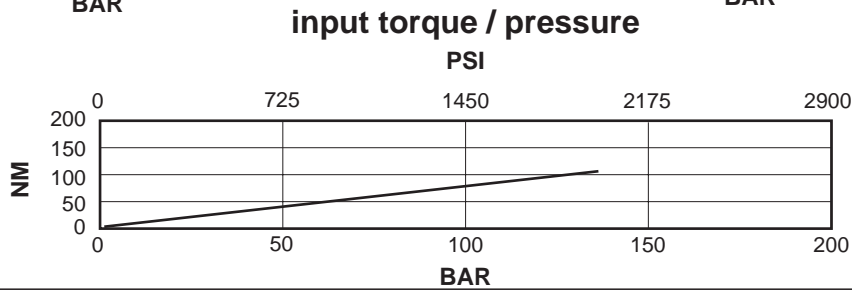
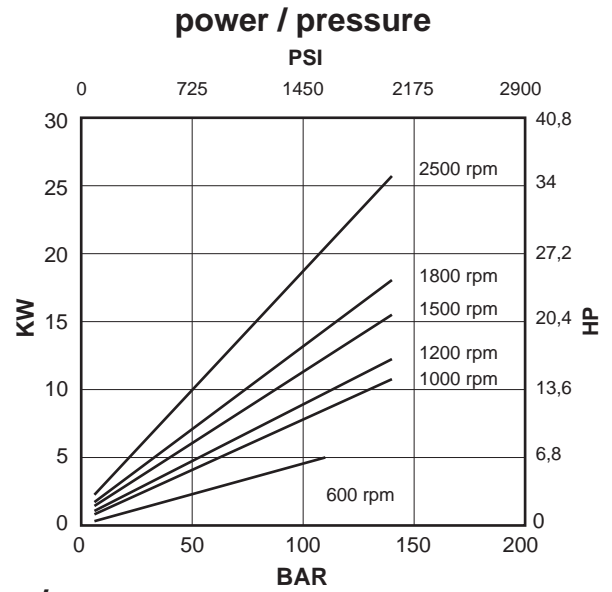
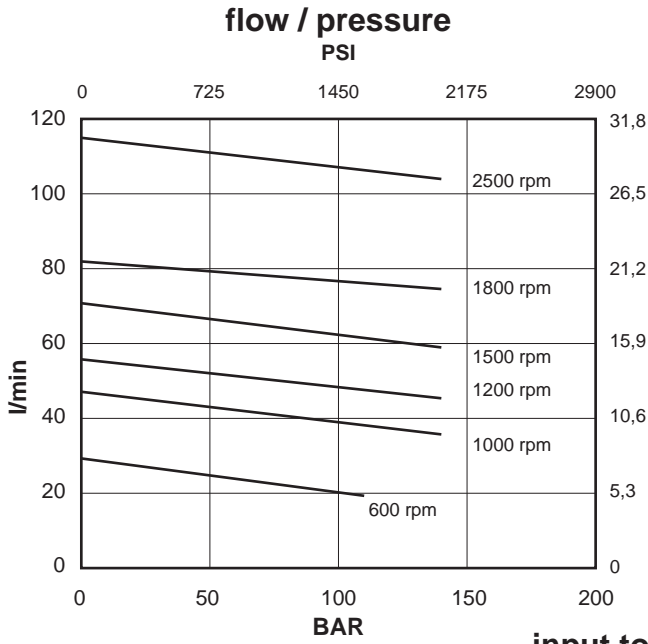

Oil viscosity: 25 c.St.(10W)
 Temperature: 45°C
 Inlet pressure: 0 BAR

Installation dimensions mm (inches)

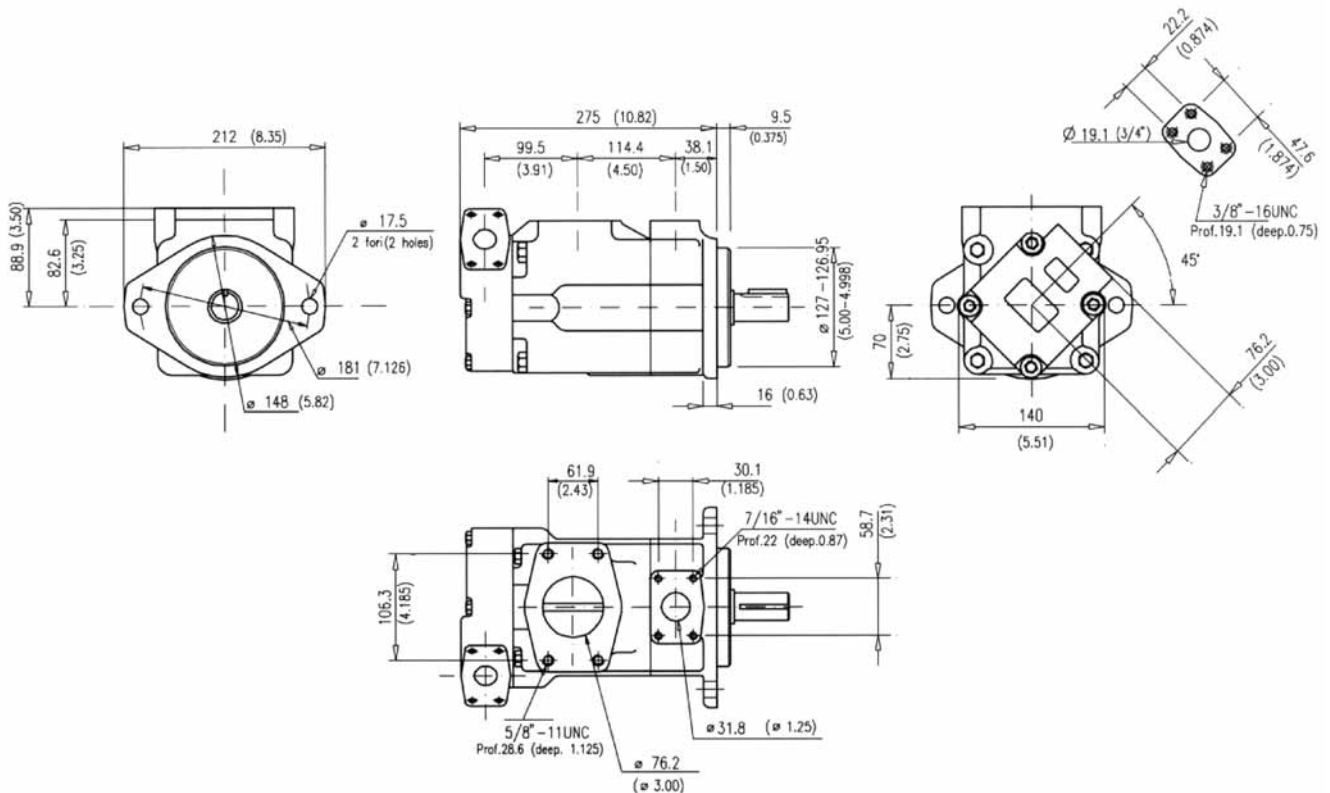

Approx. weight: 34 Kg. (75 lbs.)

Model code breakdown

<p>BV 41 G ** ** * * ** (L) * (A)</p> <p>Pump series</p> <p>Design</p> <p>Pump type</p> <p>Cartridge types</p> <p>-shaft end 21 25 30 35 38</p> <p>-cover end 02 05 08 09 11 12 14</p> <p>Body outlet port positions (outlet viewed from cover end)</p> <p>A = Outlet opposite end B = Outlet 90° CCW from inlet C = Outlet in line with inlet D = Outlet 90° CW from inlet</p> <p>Cover outlet port positions (outlet viewed from cover end)</p> <p>A = Outlet 135° CCW from inlet B = Outlet 45° CCW from inlet C = Outlet 45° CW from inlet D = Outlet 135° CW from inlet</p>	<p>Mounting (omit if not required)</p> <p>Seals (omit with standard seals and one shaft-seal in NBR)</p> <p>V = seals and shaft-seal in FPM (Viton®)</p> <p>D = standard seals and double shaft-seals in NBR</p> <p>F = seals and double shaft-seals in FPM (Viton®)</p> <p>Rotation (viewed from shaft end)</p> <p>L = left hand rotation CCW (omit if CW)</p>
---	---

Shaft end options

01 = Straight with key (standard), **11** = Splined
86 = Heavy duty straight keyed, **90** = Splined SAE C

Shaft options mm (inches)

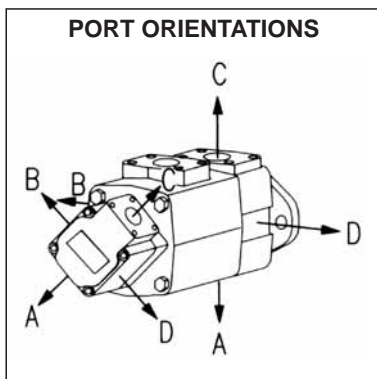
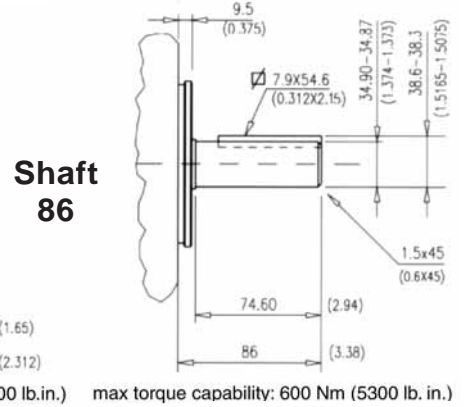
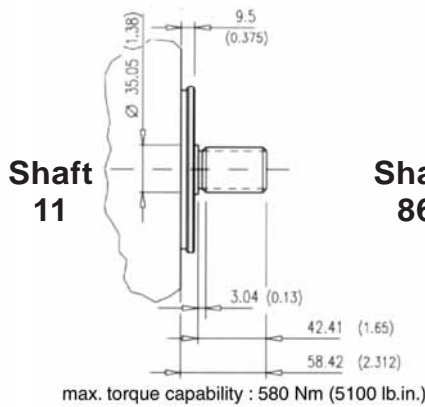
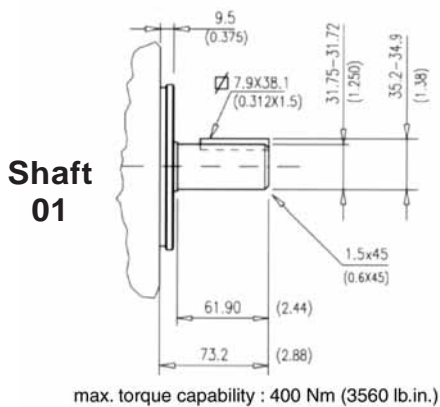

Spline data (shaft 11 and shaft 90)	
Involute side fit (ASA B5.15)	
Spline	
Pressure angle	30°
No. of teeth	14
Pitch	12/24
Major dia.	31.60 - 31.50 (1.244 - 1.240)
Pitch dia.	29.634 (1.1667)
Minor dia.	26.99 - 26.66 (1.0627 - 1.05)
Wildhaber	15.68 - 15.73 (0.617 - 0.619)

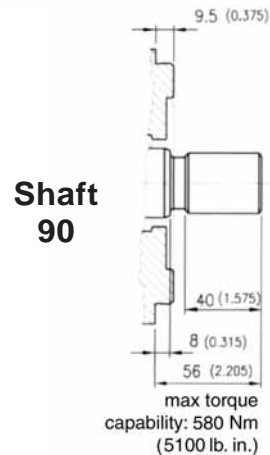

Id. codes of pump components

Cartridges				Pump rotation	
cover end		shaft end			
Series	Model	Part No.	Series	Model	Part No.
V01	02	V0102000	V04	21	V0421030
	05	V0105010		25	V0425070
	08	V0108030		30	V0430110
	09	V0109050		35	V0435150
	11	V0111070		38	V0438190
	12	V0112090			
	14	V0114110			
V01	02	V0102005	V04	21	V0421040
	05	V0105020		25	V0425080
	08	V0108040		30	V0430120
	09	V0109060		35	V0435160
	11	V0111080		38	V0438200
	12	V0112100			
	14	V0114120			

Shaft kit		Shaft		Key		Body	
Model	Part No.	Model	Part No.	Part No.	Part No.	Part No.	Part No.
01	M8410601	01	K4101000	M8040100	M8040140		
11	M8410611	11	K4111000	-			
86	M8410686	86	K4186000	M8048600			
90	M8410690	90	K4190000	-			

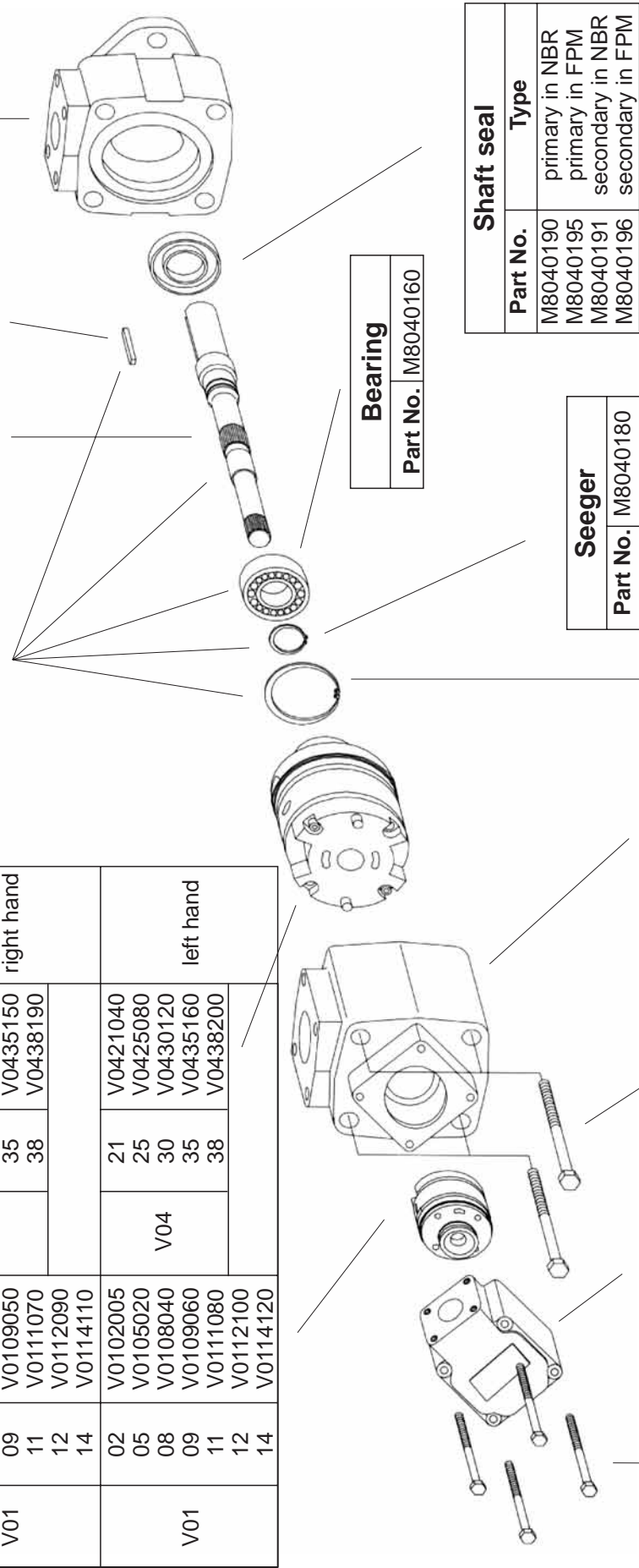

Bearing
Part No. M8040160

Seeger
Part No. M8040180

Part No.	Shaft seal Type
M8040190	primary in NBR
M8040195	primary in FPM
M8040191	secondary in NBR
M8040196	secondary in FPM

Inlet body
Part No. M8040430

Cover
Part No. M8020120

Screw
Part No. M8040210
Torque to 225 Nm (2010 lb. in.)

Screw
Part No. M8020420
Torque to 70 Nm (624 lb. in.)

Pump seal kit	
Part No.	Parts
M8410500	seals + 1 shaft seal
M8410501	seals + 2 shaft seals
M8410503	seals + 1 shaft seal
M8410504	seals + 2 shaft seals

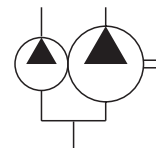
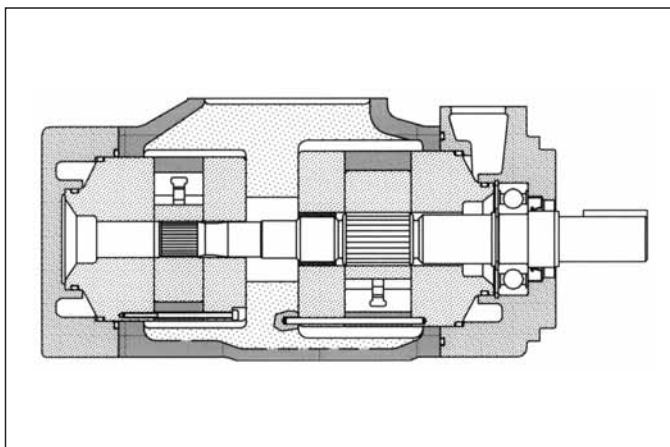

General description

Fixed displacement vane pump, hydraulically balanced, with capacity determined by the cartridges used and the speed of rotation. The pump is available in several versions with rated capacities from 127 to 219 l/min (from 33 to 59 gpm) at 1200 rpm and 7 bar.

Technical characteristics

Cartridge model	Geometric displacement		Rated capacity at 1200 rpm 7 bar		Rated capacity at 1500 rpm 7 bar		Maximum pressure with mineral oil		Speed range rpm	
	cm ³ /g	(in ³ /r)	l/min	(gpm)	l/min	(gpm)	bar	(psi)	min	max
shaft end										
V04-21	69,0	(4.2)	79,5	(21)	101,4	(26.8)	175	(2538)	600	1800
V04-25	81,6	(5)	94,0	(25)	120,1	(31.7)	175	(2538)	600	1800
V04-30	97,7	(6)	113,8	(30)	141,2	(37.3)	175	(2538)	600	1800
V04-35	112,7	(6.9)	131,6	(35)	167,2	(44.1)	175	(2538)	600	1800
V04-38	121,6	(7.4)	139,9	(38)	177,3	(46.8)	175	(2538)	600	1800
cover end										
V02-12	40,1	(2.45)	46,9	(12)	58,8	(15.5)	175	(2538)	600	1800
V02-14	45,4	(2.77)	52,7	(14)	65,7	(17.4)	175	(2538)	600	1800
V02-17	55,2	(3.37)	64,2	(17)	80,2	(21.2)	175	(2538)	600	1800
V02-19	60,0	(3.66)	71,0	(19)	88,7	(23.4)	175	(2538)	600	1800
V02-21	67,5	(4.12)	79,0	(21)	99,8	(26.4)	175	(2538)	600	1800

Hydraulic fluids: antiwear high quality mineral oils or fire resistant fluid having same lubrication capacities of the mineral oil.

Viscosity range (with mineral oil): from 13 to 860 cSt. (13 to 54 cSt. recommended).

Filtration: for the inlet - 149 micron abs., for the return line - 25 micron abs. or better (with synthetic fluids: for the return line - 10 micron abs. or better).

Inlet pressure: (with mineral oil): from -0,17 to +1,4 bar (-2.5 to + 20 psi)

Operating temperature: with mineral oil -10°C +70°C (+30°C to +60°C recommended), with water based fluids +15°C to +50°C.

Drive: direct and coaxial by means of a flexible coupling.

Main operating data

max pressure / hydraulic fluid

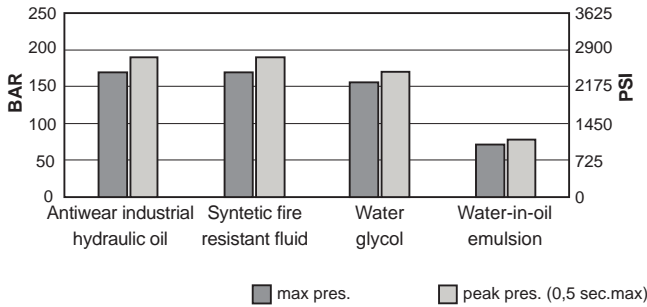

max speed / hydraulic fluid (with 0 bar in the intake pipe)

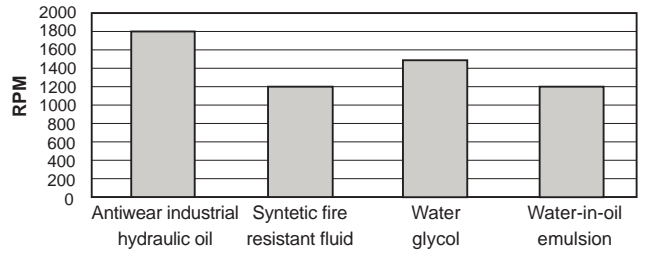

If the intake pressure is not zero bar, use the graph below to find the percentage correction factor to apply to the maximum speed

max speed / intake pipe pressure

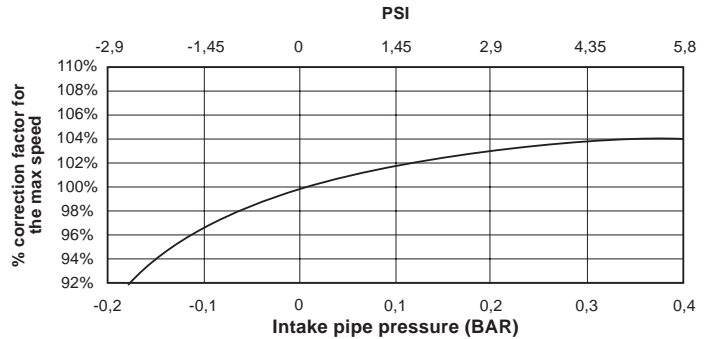

Sound level at 138 bar (2000 psi)

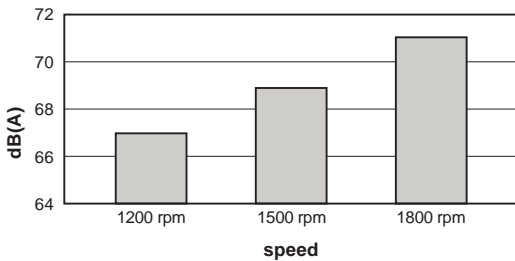

flow / pressure

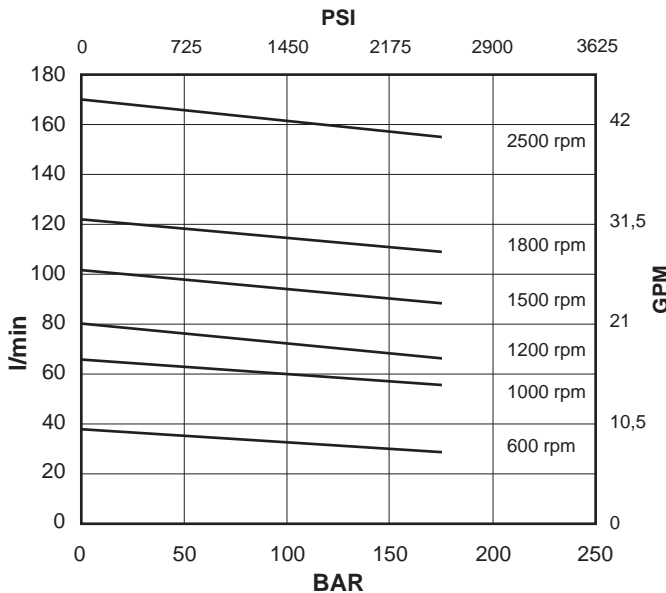

Shaft end cartridge V04-21

power / pressure

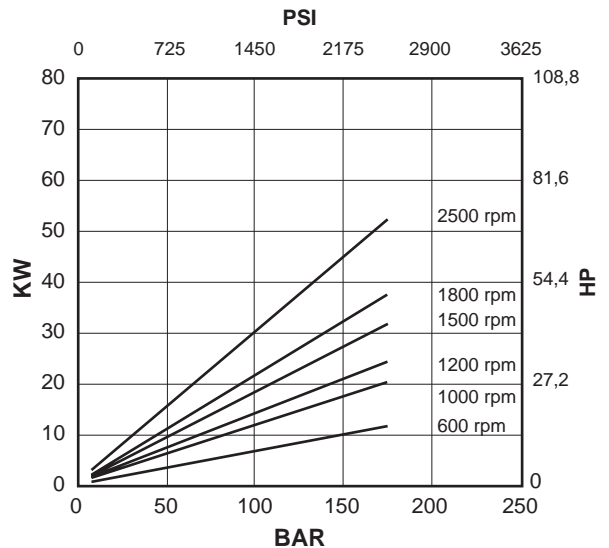

input torque / pressure

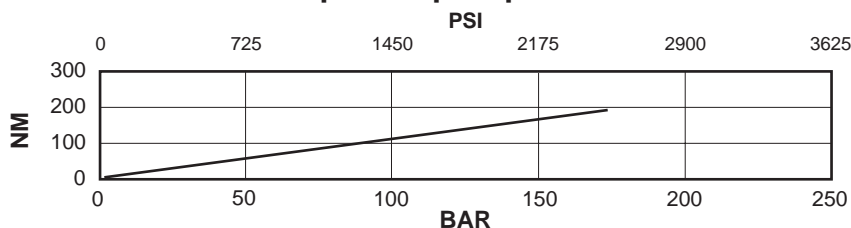

Oil viscosity: 25 c.St.(10W)
 Temperature: 45°C
 Inlet pressure: 0 BAR

Shaft end cartridge V04-25

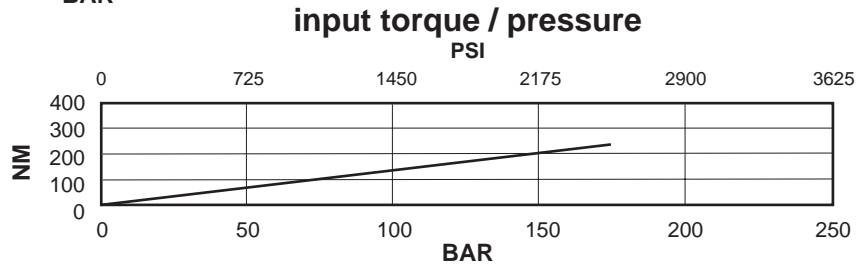
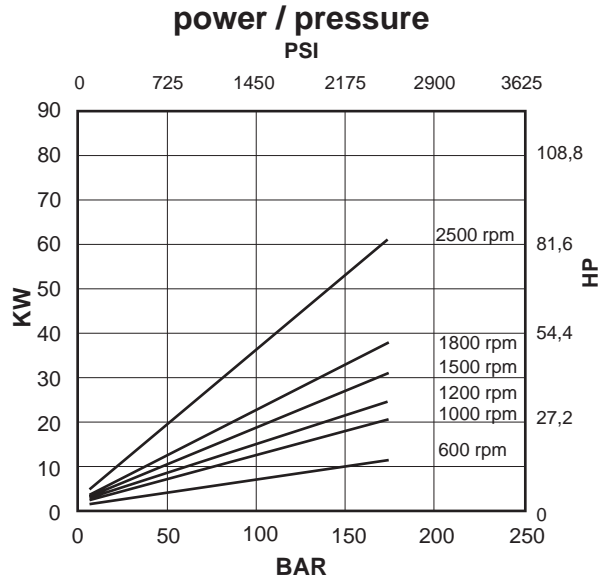
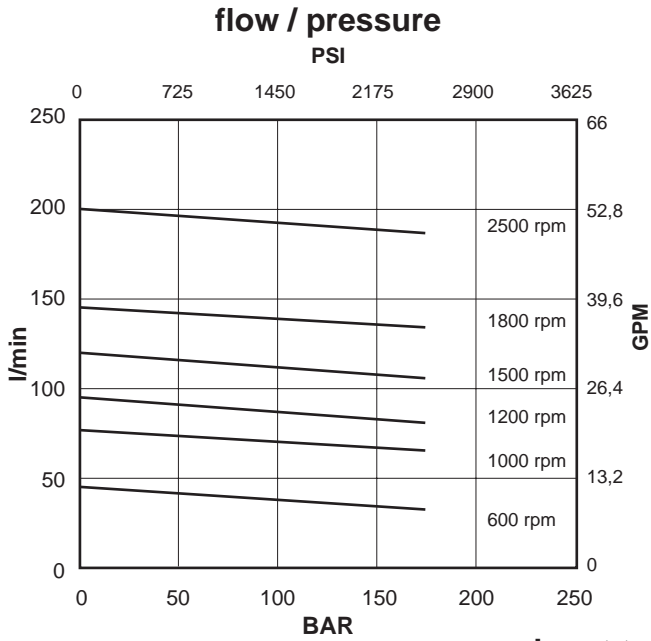

Oil viscosity: 25 c.St.(10W)
 Temperature: 45°C
 Inlet pressure: 0 BAR

Shaft end cartridge V04-30

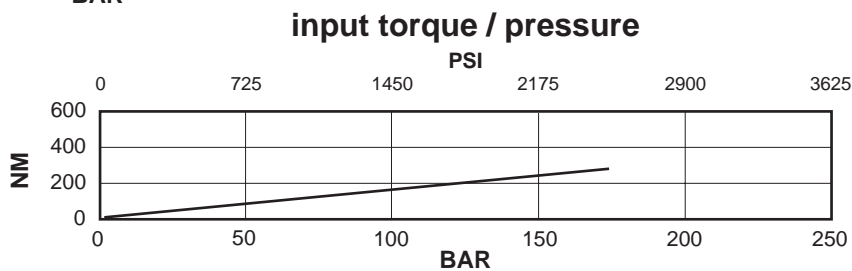
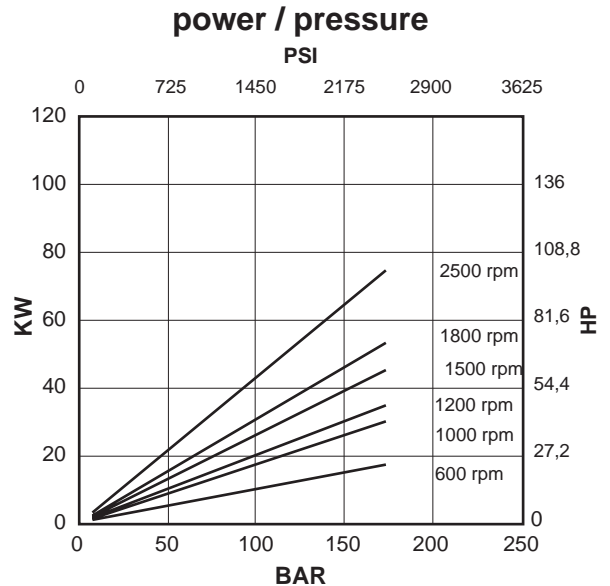
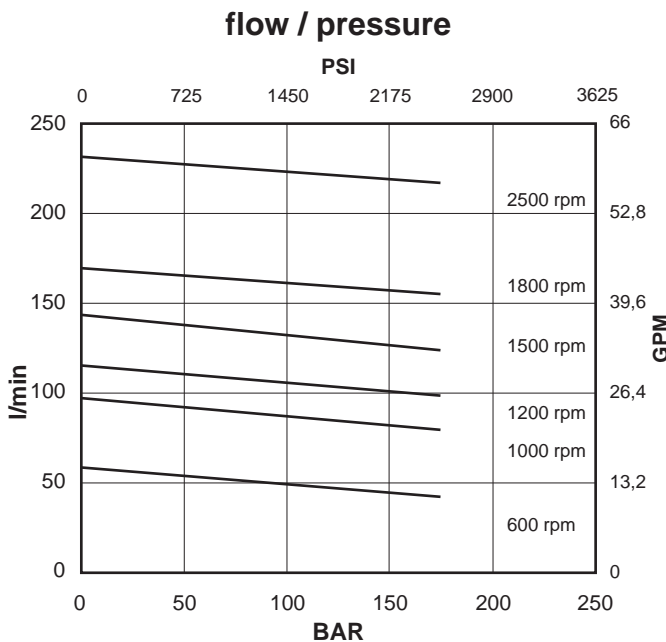

Oil viscosity: 25 c.St.(10W)
 Temperature: 45°C
 Inlet pressure: 0 BAR

Shaft end cartridge V04-35

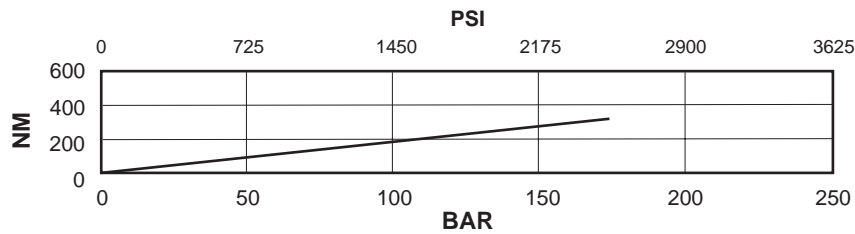
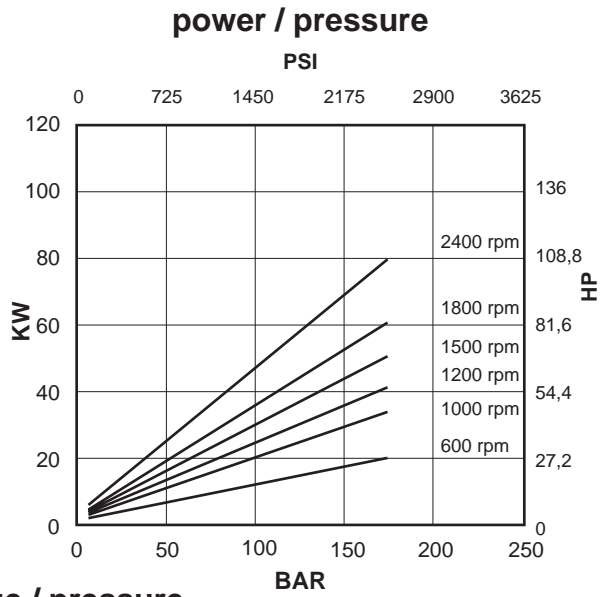
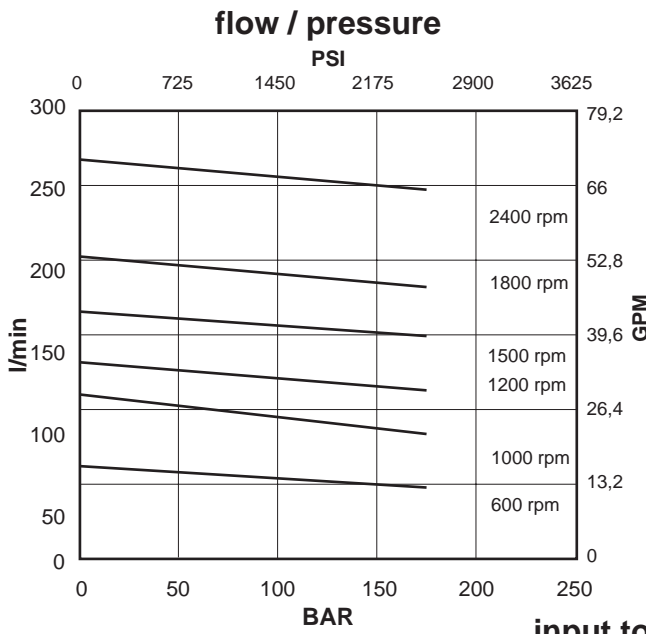

Oil viscosity: 25 c.St.(10W)
 Temperature: 45°C
 Inlet pressure: 0 BAR

Shaft end cartridge V04-38

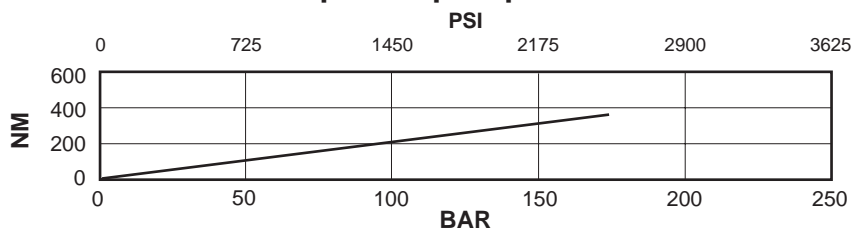
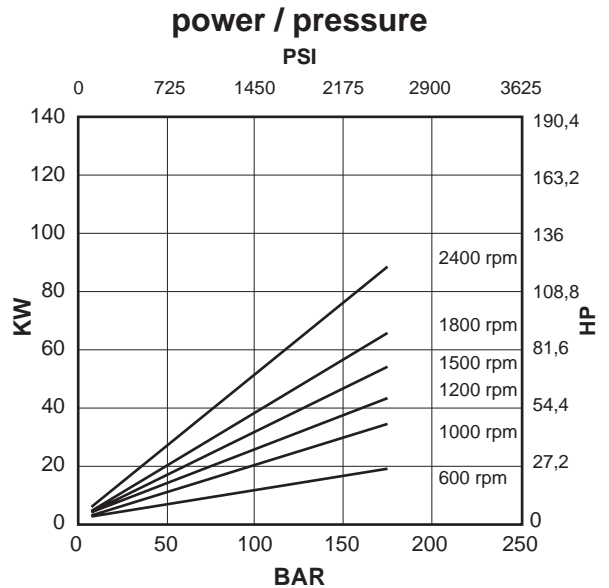
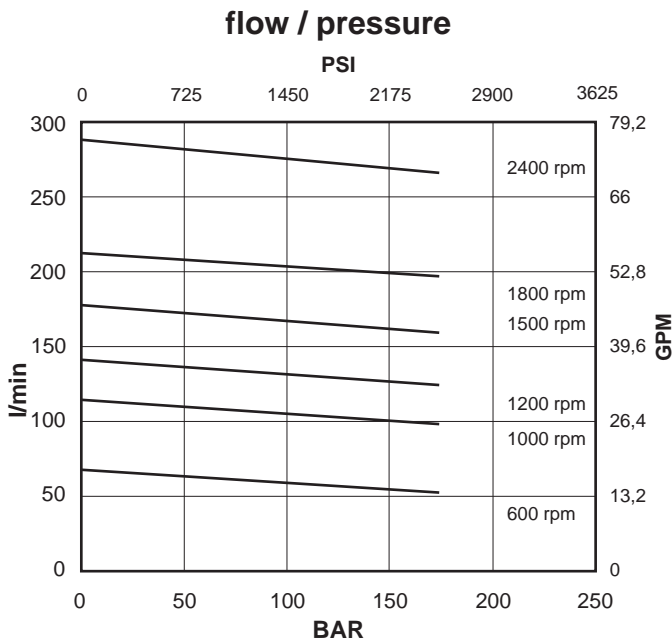

Oil viscosity: 25 c.St.(10W)
 Temperature: 45°C
 Inlet pressure: 0 BAR

Cover end cartridge V02-12

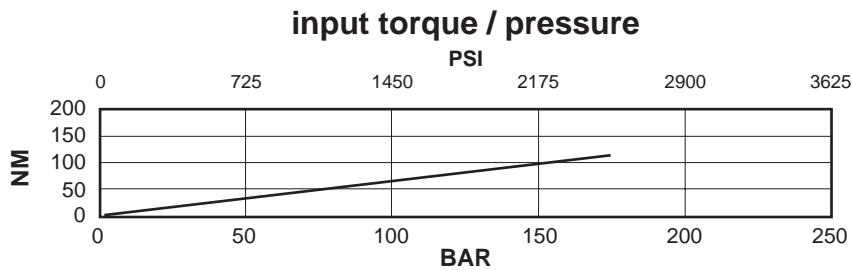
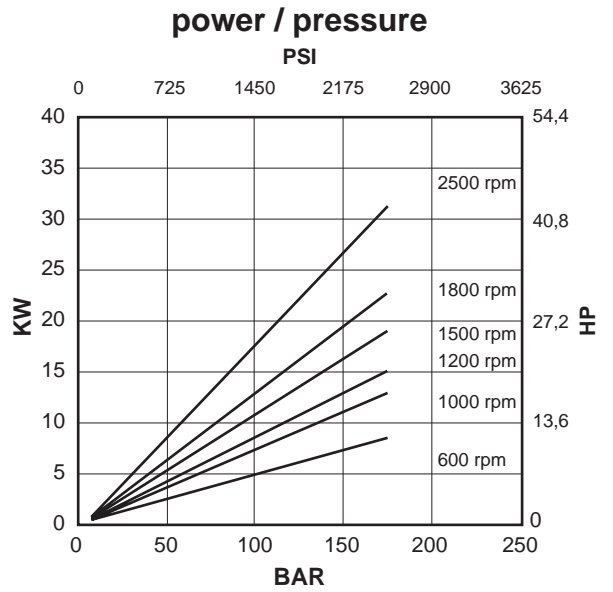
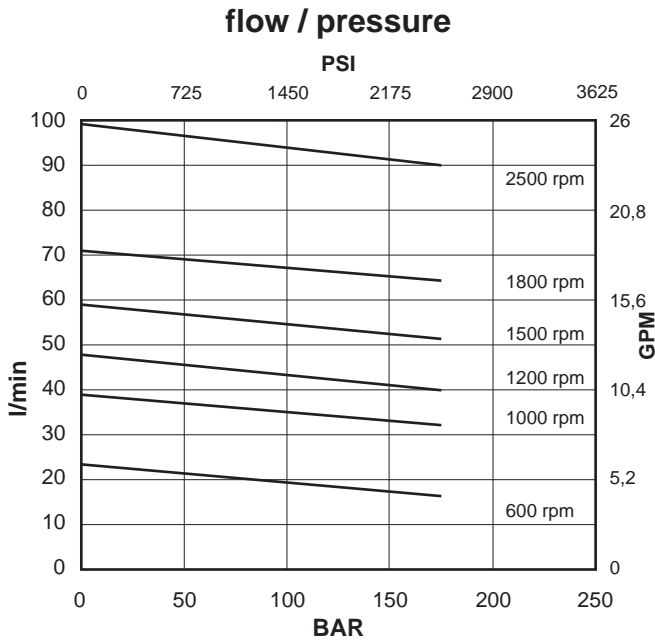

Oil viscosity: 25 c.St.(10W)
 Temperature: 45°C
 Inlet pressure: 0 BAR

Cover end cartridge V02-14

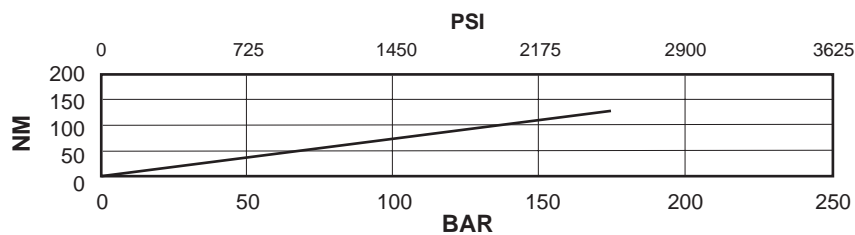
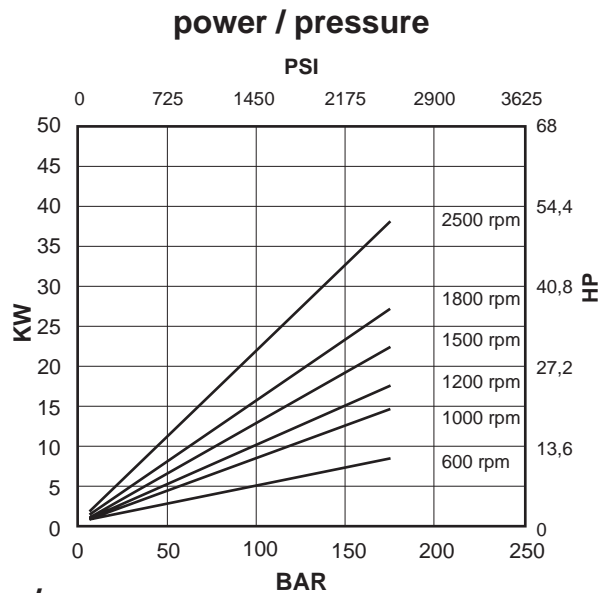
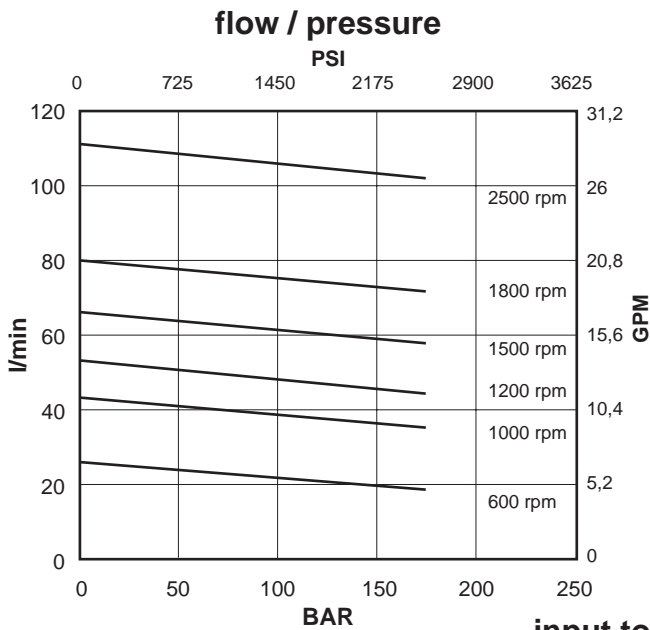

Oil viscosity: 25 c.St.(10W)
 Temperature: 45°C
 Inlet pressure: 0 BAR

Cover end cartridge V02-17

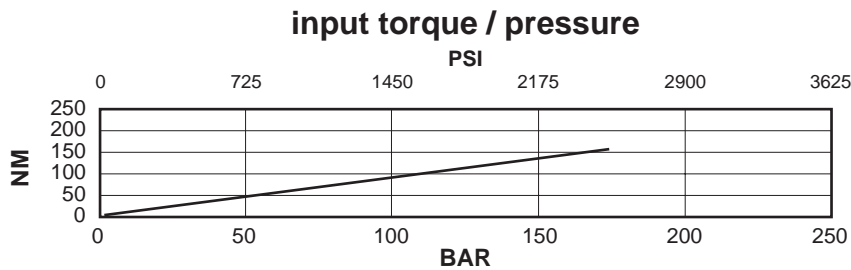
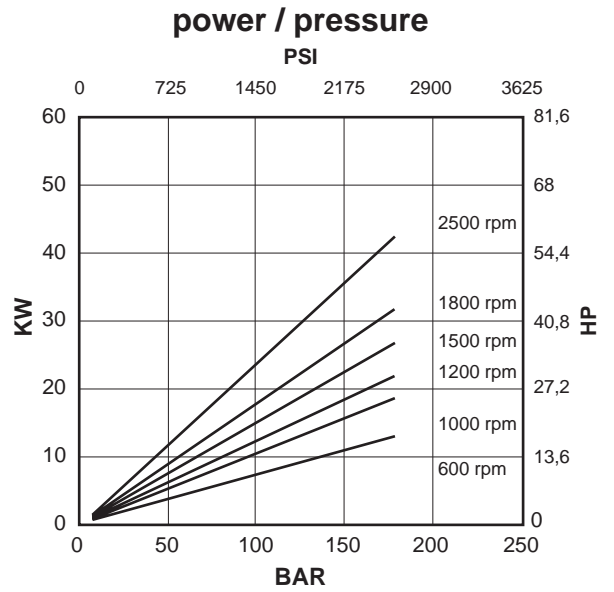
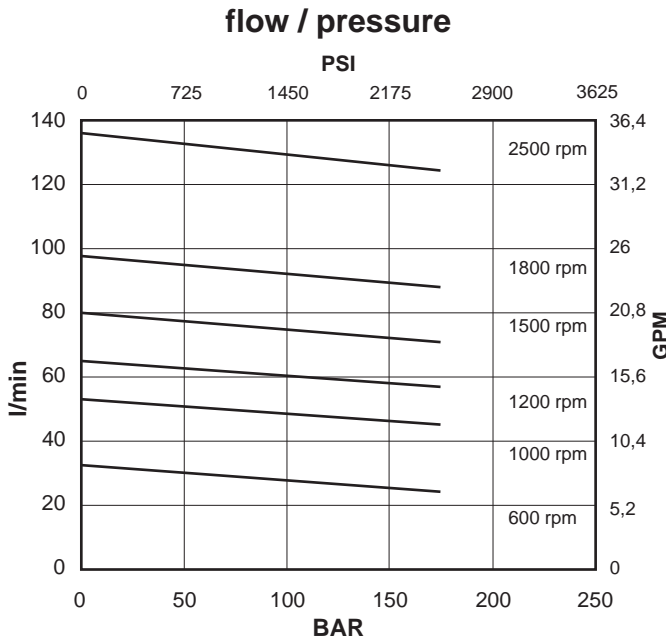

Oil viscosity: 25 c.St.(10W)
 Temperature: 45°C
 Inlet pressure: 0 BAR

Cover end cartridge V02-19

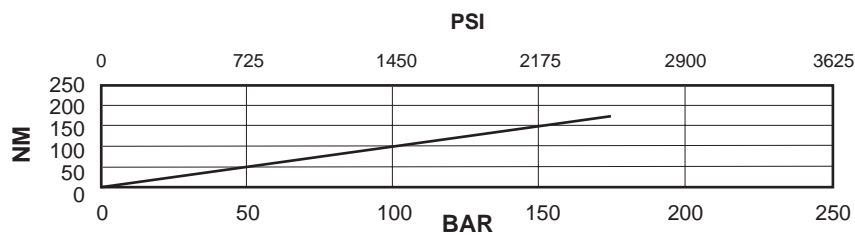
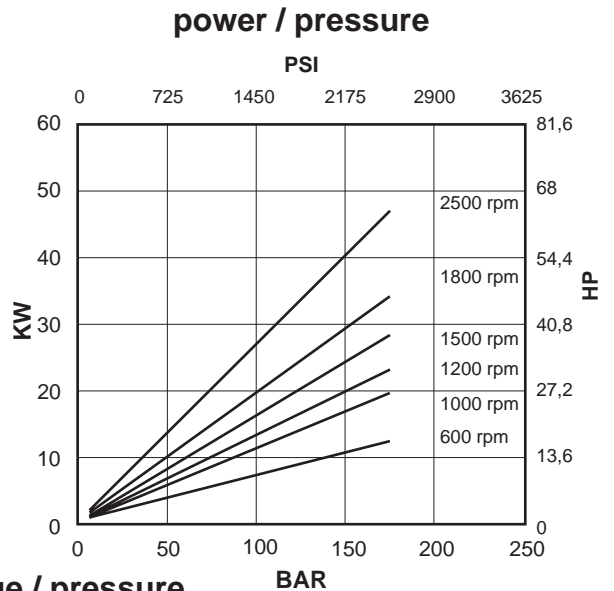
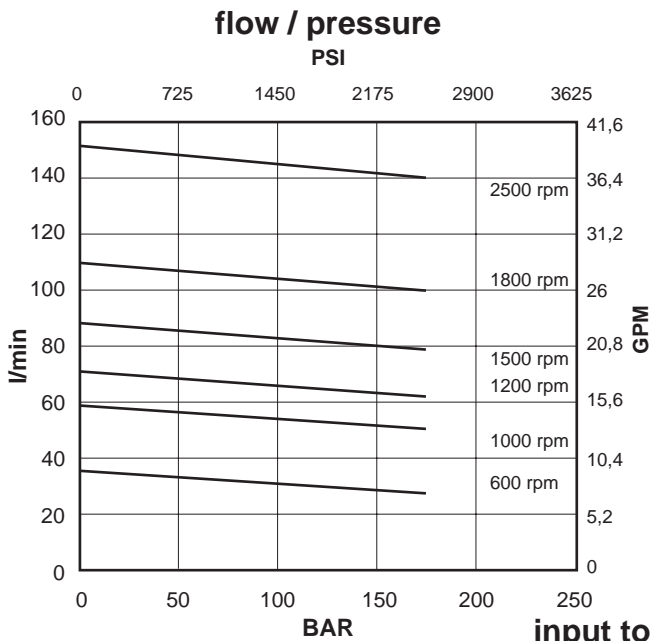

Oil viscosity: 25 c.St.(10W)
 Temperature: 45°C
 Inlet pressure: 0 BAR

Cover end cartridge V02-21

flow / pressure

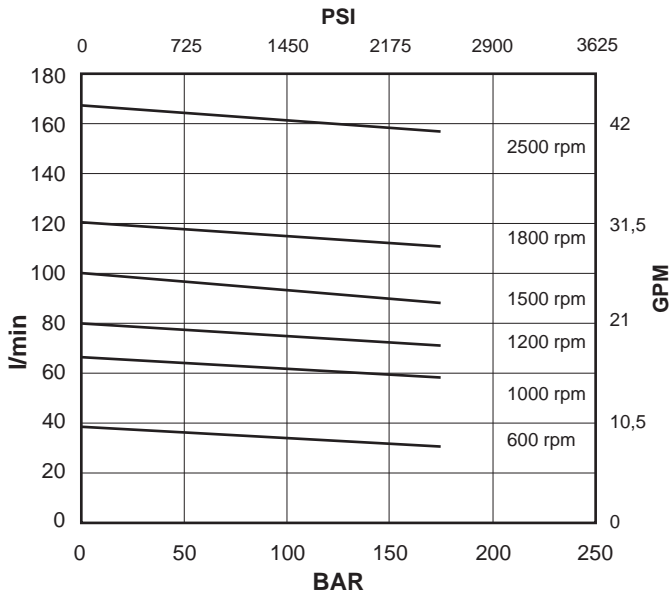

power / pressure

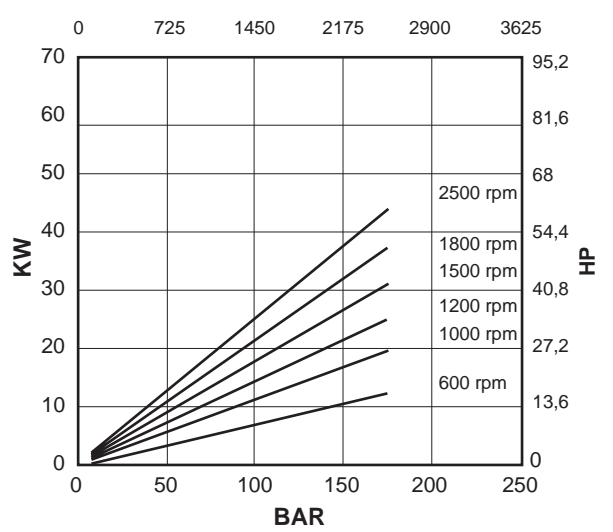

input torque / pressure

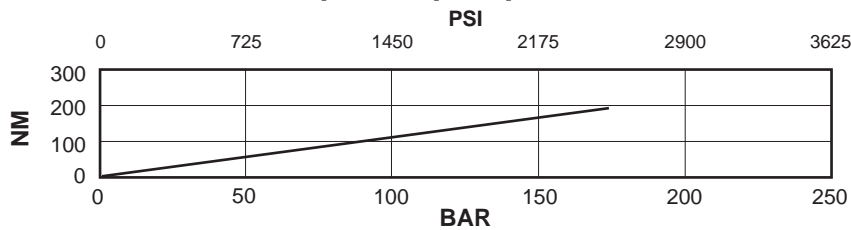

Oil viscosity: 25 c.St.(10W)
 Temperature: 45°C
 Inlet pressure: 0 BAR

Installation dimensions mm (inches)

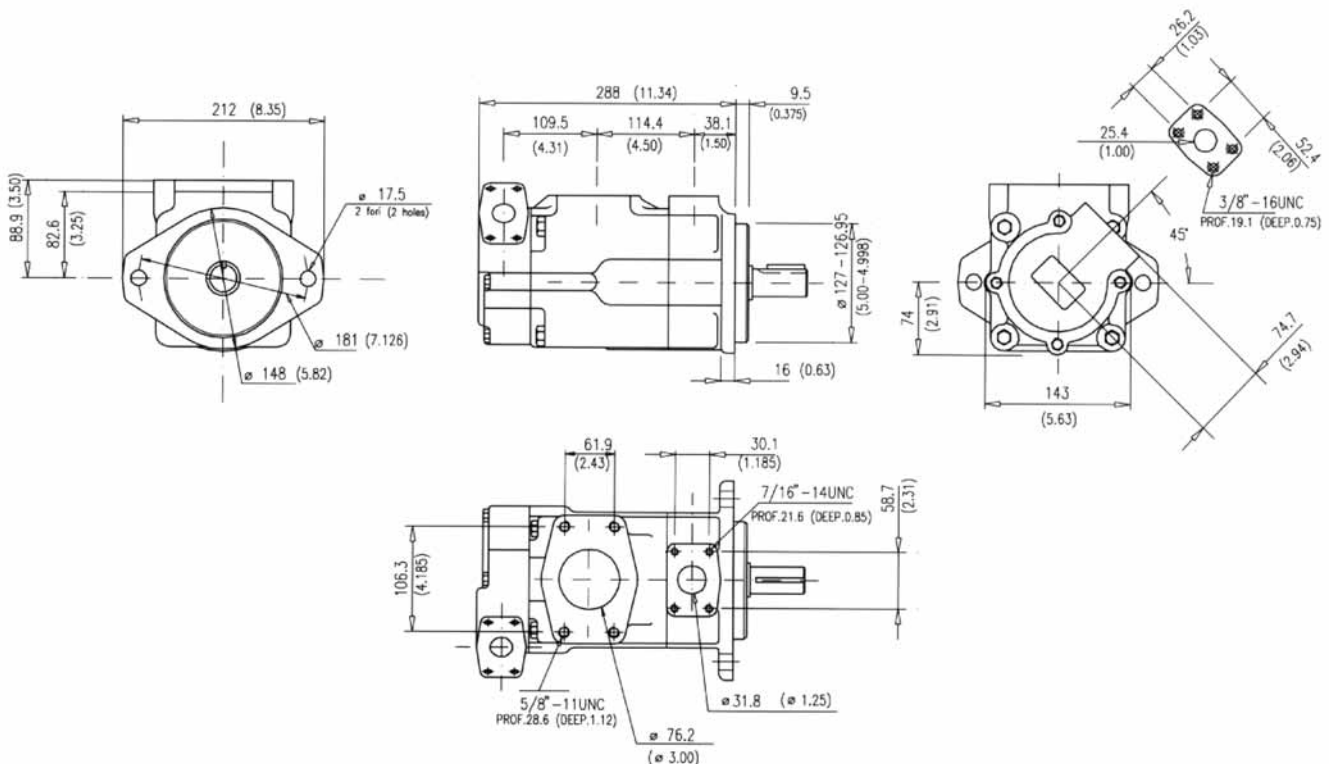

Approx. weight: 34,5 Kg. (76 lbs.)

Model code breakdown

BV 42 G ** ** * * ** (L) * (A)

Pump series | **Design** | **Mounting**
(omit if not required)

Pump type

Cartridge types

-shaft end 21 25 30 35 38 | **Seals**
(omit with standard seals and one shaft-seal in NBR)
V = seals and shaft-seal in FPM (Viton®)
D = standard seals and double shaft-seals in NBR
F = seals and double shaft-seals in FPM (Viton®)

-cover end 12 14 17 19 21

Body outlet port positions
(outlet viewed from cover end)
A = Outlet opposite end
B = Outlet 90° CCW from inlet
C = Outlet in line with inlet
D = Outlet 90° CW from inlet

Rotation
(viewed from shaft end)
L = left hand rotation CCW (omit if CW)

Cover outlet port positions
(outlet viewed from cover end)
A = Outlet 135° CCW from inlet
B = Outlet 45° CCW from inlet
C = Outlet 45° CW from inlet
D = Outlet 135° CW from inlet

Shaft end options
01 = Straight with key (standard), **11** = Splined
86 = Heavy duty straight keyed, **90** = Splined SAE C

Shaft options mm (inches)

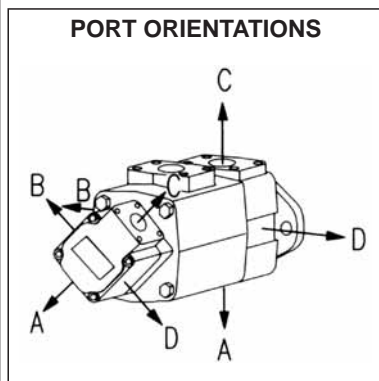
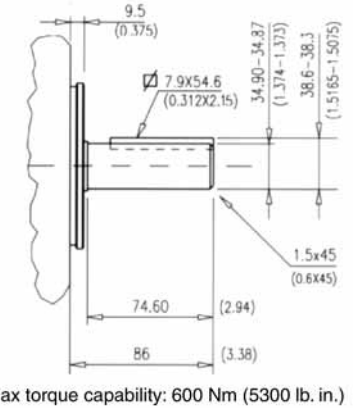
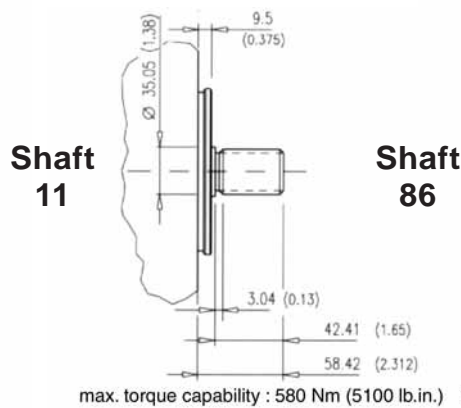
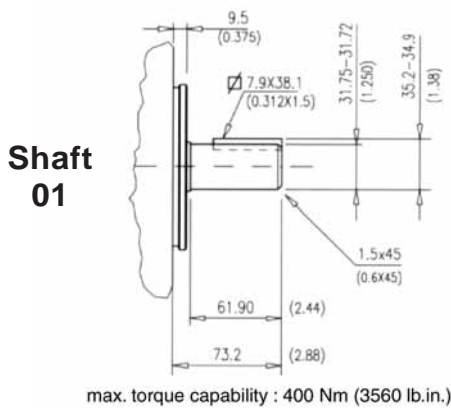

Spline data
(shaft 11 and shaft 90)

Spline	Involute side fit (ASA B5.15)	
Pressure angle	30°	
No. of teeth	14	
Pitch	12/24	
Major dia.	31.60 - 31.50	(1.244 - 1.240)
Pitch dia.	29.634	(1.1667)
Minor dia.	26.99 - 26.66	(1.0627 - 1.05)
Wildhaber	15.68 - 15.73	(0.617 - 0.619)

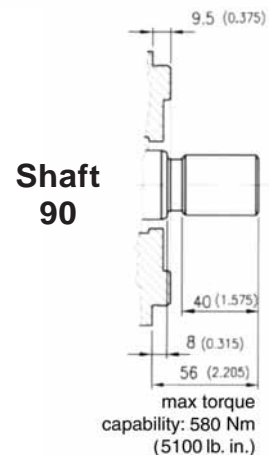

Id. codes of pump components

Cartridges				Pump rotation	
cover end		shaft end			
Series	Model	Part No.	Series	Model	Part No.
V02	12	V0212010	V04	21	V0421030
	14	V0214050		25	V0425070
	17	V0217090		30	V0430110
	19	V0219130		35	V0435150
	21	V0221170		38	V0438190
V02	12	V0212020	V04	21	V0421040
	14	V0214060		25	V0425080
	17	V0217100		30	V0430120
	19	V0219140		35	V0435160
	21	V0221180		38	V0438200

Shaft kit		Shaft		Key		Body	
Model	Part No.	Model	Part No.	Part No.	Part No.	Part No.	Part No.
01	M8420601	01	K4201000	M8040100	M8040140		
11	M8420611	11	K4211000	-			
86	M8420686	86	K4286000	M8048600			
90	M8420690	90	K4290000	-			

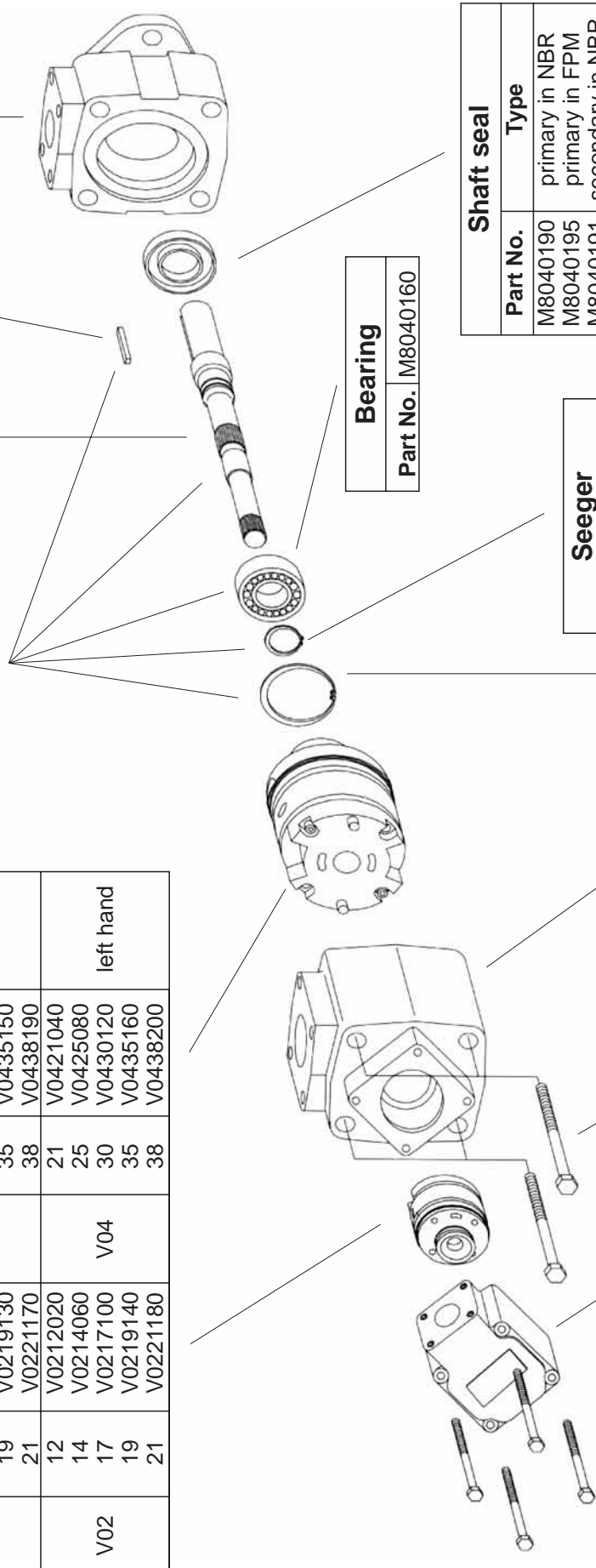

Cover
Part No. M8050350

Intel body
Part No. M8040240

Bearing
Part No. M8040160

Seeger
Part No. M8040180

Shaft seal	
Part No.	Type
M8040190	primary in NBR
M8040195	primary in FPM
M8040191	secondary in NBR
M8040196	secondary in FPM

Pump seal kit		
Part No.	Parts	Type
M8420500	seals + 1 shaft seal	NBR
M8420501	seals + 2 shaft seals	NBR
M8420503	seals + 1 shaft seal	FPM (Viton®)
M8420504	seals + 2 shaft seals	FPM (Viton®)

Screw
Part No. M8040230
Torque to 102 Nm (910 lb. in.)

Screw
Part No. M8040220
Torque to 225 Nm (2010 lb. in.)

Seeger
Part No. M8040170

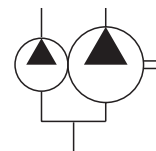
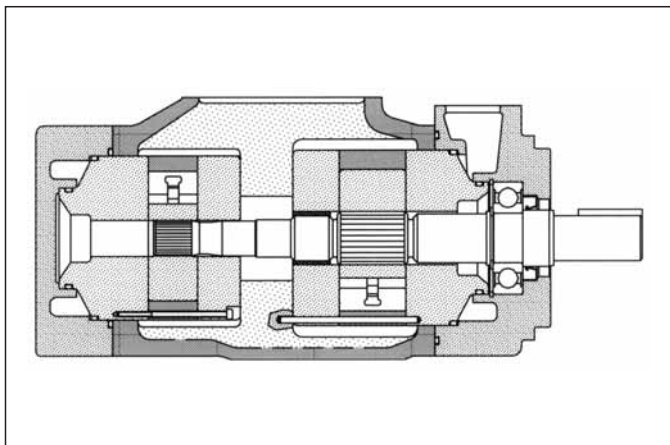

General description

Fixed displacement vane pump, hydraulically balanced, with capacity determined by the cartridges used and the speed of rotation. The pump is available in several versions with rated capacities from 172 to 285 l/min (from 44 to 74 gpm) at 1200 rpm and 7 bar.

Technical characteristics

Cartridge model	Geometric displacement		Rated capacity at 1200 rpm 7 bar		Rated capacity at 1500 rpm 7 bar		Maximum pressure awith mineral oil		Speed range rpm	
	cm ³ /g	(in ³ /r)	l/min	(gpm)	l/min	(gpm)	bar	(psi)	min	max
shaft end										
V05-42	138,6	(8.46)	164	(42)	203,4	(53.7)	175	(2538)	600	1800
V05-47	153,5	(9.4)	180	(47)	222,7	(58.8)	175	(2538)	600	1800
V05-50	162,2	(9.9)	189	(50)	234	(61.8)	175	(2538)	600	1800
V05-57	183,4	(11.2)	217	(57)	267	(71.2)	175	(2538)	600	1800
V05-60	193,4	(11.8)	230	(60)	285	(75.3)	175	(2538)	600	1800
cover end										
V01-02	7,2	(0.44)	8,3	(2)	10,4	(2.8)	210	(3050)	600	2700
V01-05	18,0	(1.10)	20,8	(5)	26,1	(6.9)	210	(3050)	600	2700
V01-08	27,4	(1.67)	31,8	(8)	39,4	(10.4)	210	(3050)	600	2700
V01-09	30,1	(1.83)	35,1	(9)	44,1	(11.7)	210	(3050)	600	2700
V01-11	36,4	(2.22)	42,4	(11)	52,6	(13.9)	210	(3050)	600	2700
V01-12	39,5	(2.41)	46,9	(12)	58,7	(15.5)	160	(2300)	600	2700
V01-14	45,9	(2.79)	54,9	(14)	69,6	(18.4)	140	(2030)	600	2700

Hydraulic fluids: antiwear high quality mineral oils or fire resistant fluid having same lubrication capacities of the mineral oil.

Viscosity range (with mineral oil): from 13 to 860 cSt. (13 to 54 cSt. recommended).

Filtration: for the inlet - 149 micron abs., for the return line - 25 micron abs. or better (with synthetic fluids: for the return line - 10 micron abs. or better).

Inlet pressure: (with mineral oil): from -0,17 to +1,4 bar (-2.5 to + 20 psi)

Operating temperature: with mineral oil -10°C +70°C (+30°C to +60°C recommended), with water based fluids +15°C to +50°C.

Drive: direct and coaxial by means of a flexible coupling.

Main operating data

max pressure / hydraulic fluid

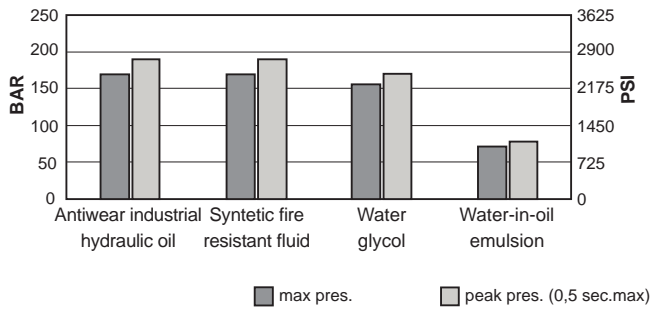

max speed / hydraulic fluid (with 0 bar in the intake pipe)

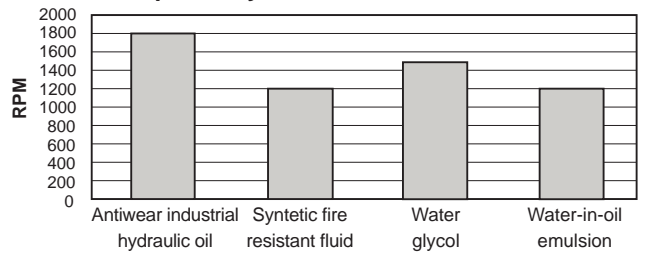

If the intake pressure is not zero bar, use the graph below to find the percentage correction factor to apply to the maximum speed

max speed / intake pipe pressure

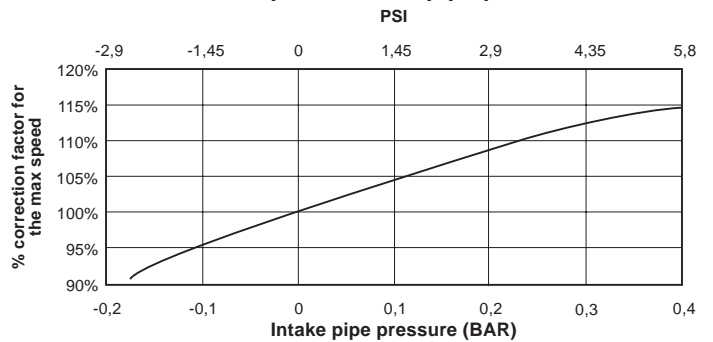

Sound level at 138 bar (2000 psi)

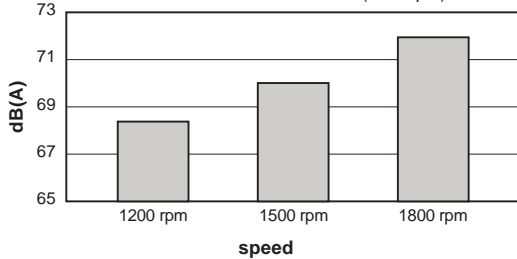

flow / pressure

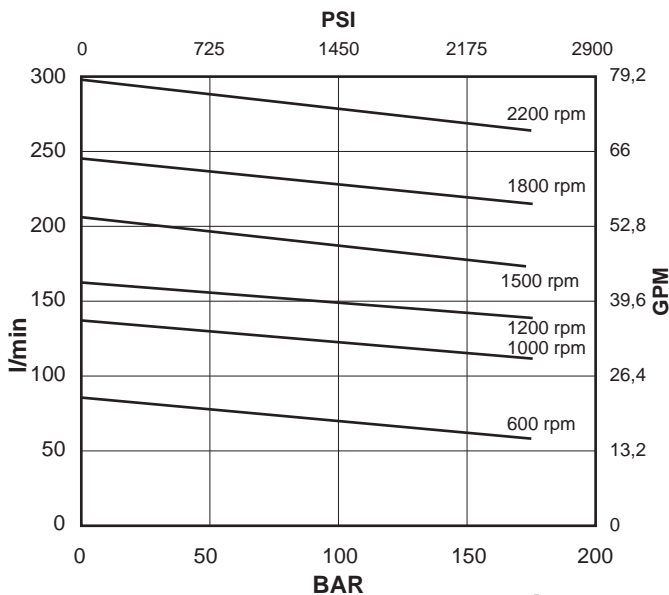

Shaft end cartridge V05-42

power / pressure

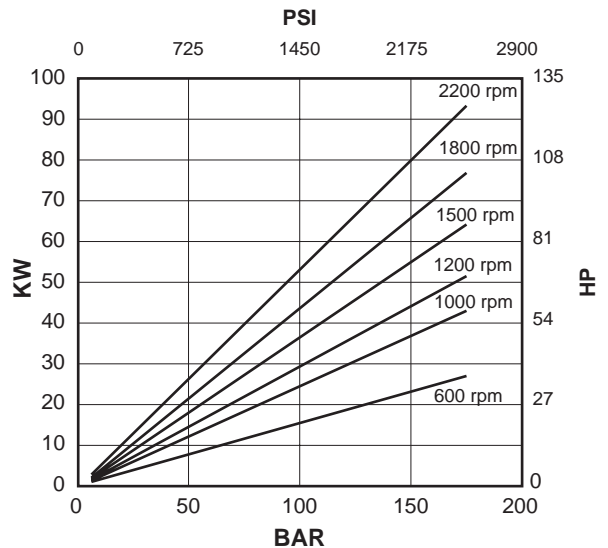

input torque / pressure

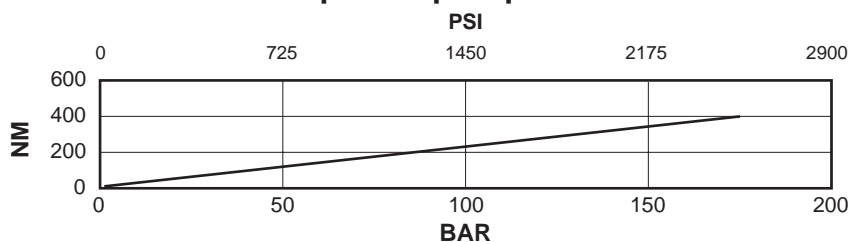

Oil viscosity: 25 c.St.(10W)
 Temperature: 45°C
 Inlet pressure: 0 BAR

Shaft end cartridge V05-47

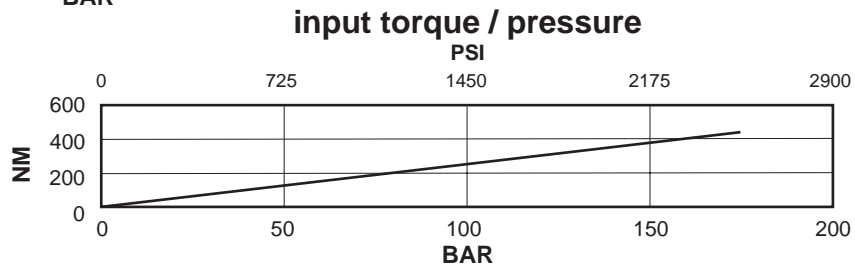
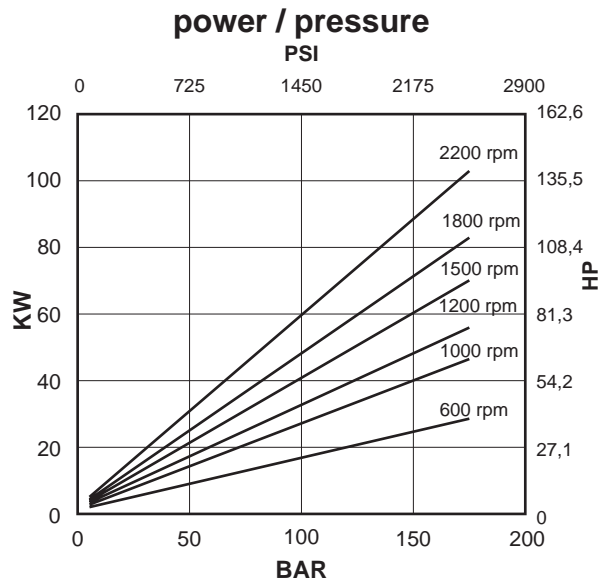
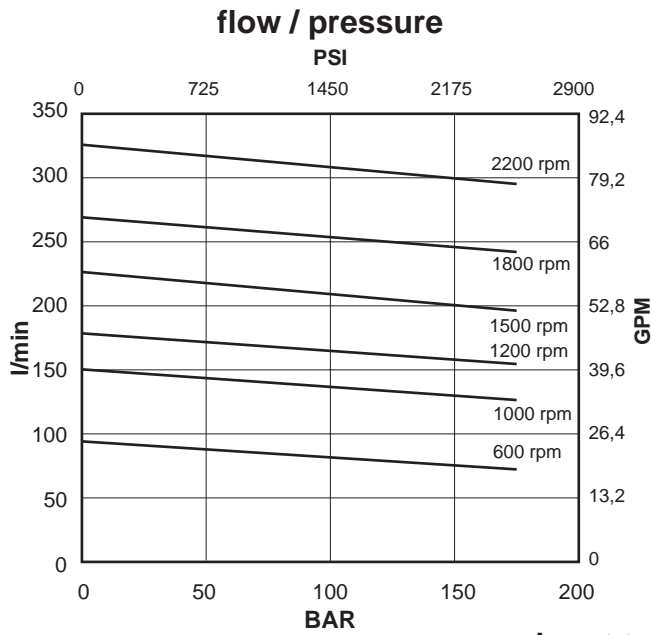

Oil viscosity: 25 c.St.(10W)
 Temperature: 45°C
 Inlet pressure: 0 BAR

Shaft end cartridge V05-50

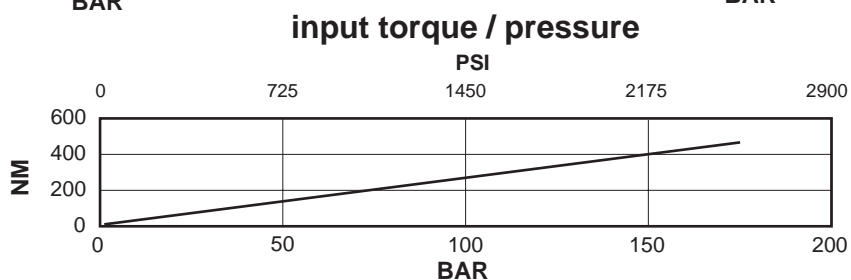
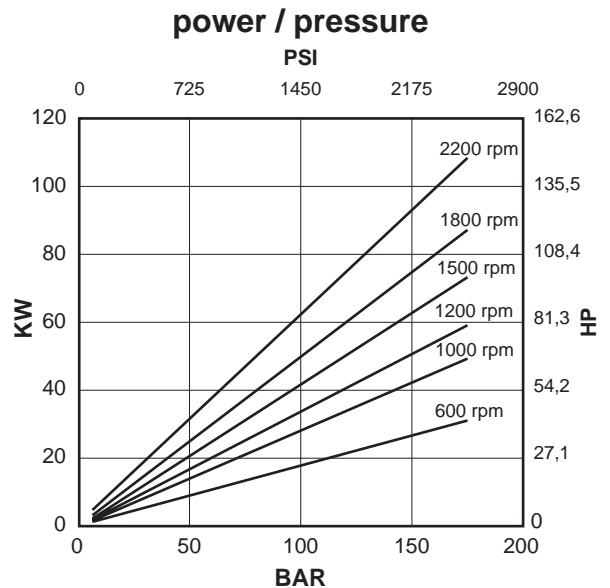
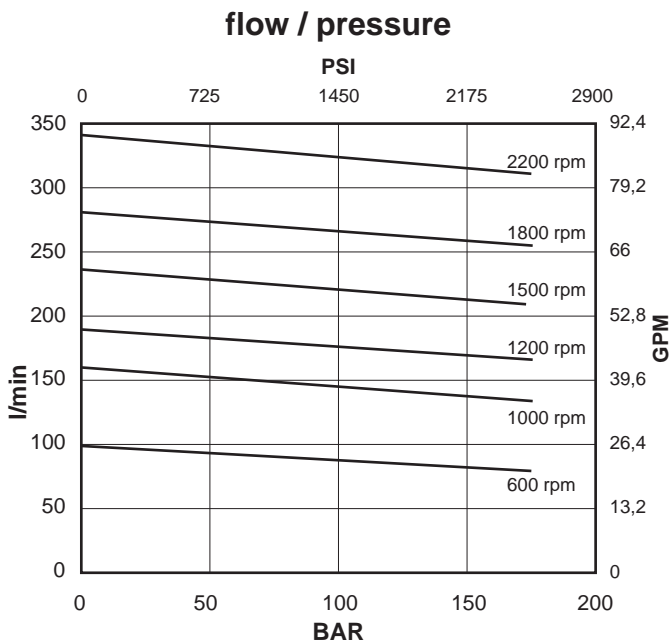

Oil viscosity: 25 c.St.(10W)
 Temperature: 45°C
 Inlet pressure: 0 BAR

Shaft end cartridge V05-57

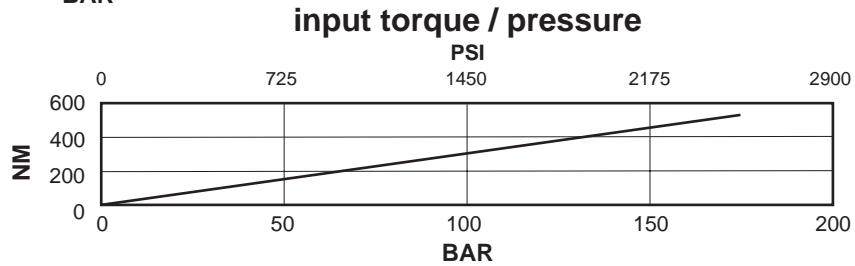
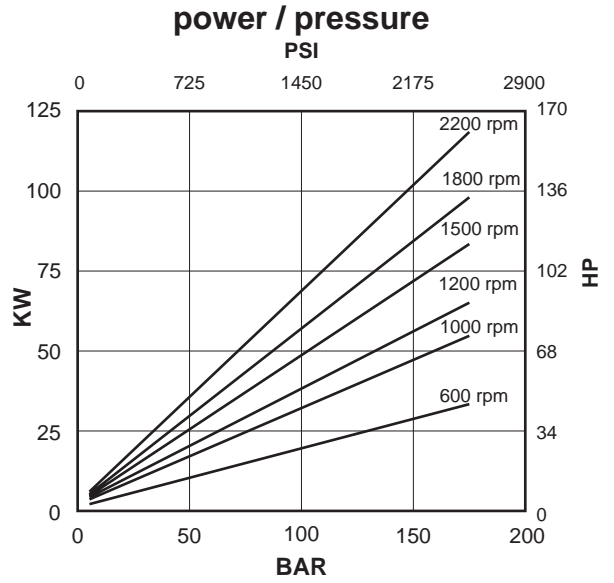
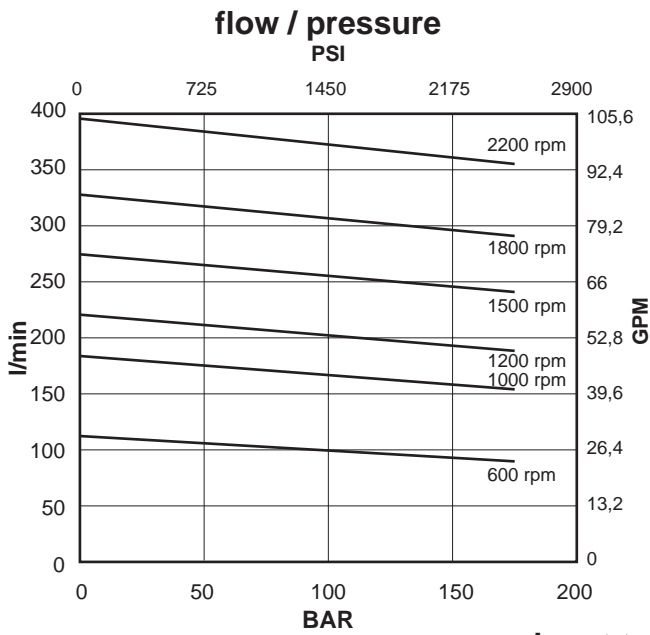

Oil viscosity: 25 c.St.(10W)
 Temperature: 45°C
 Inlet pressure: 0 BAR

Shaft end cartridge V05-60

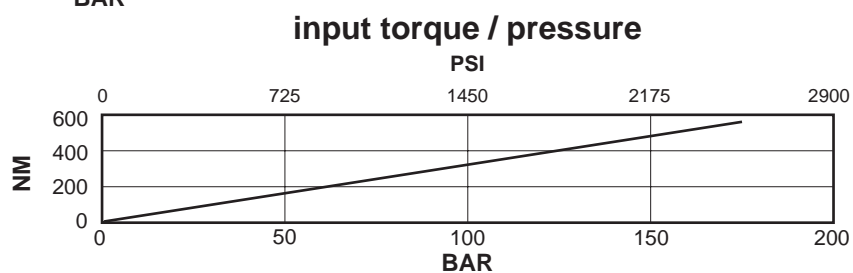
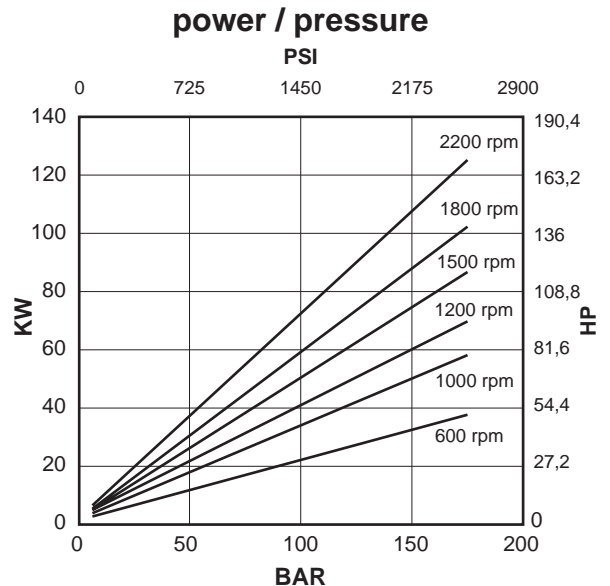
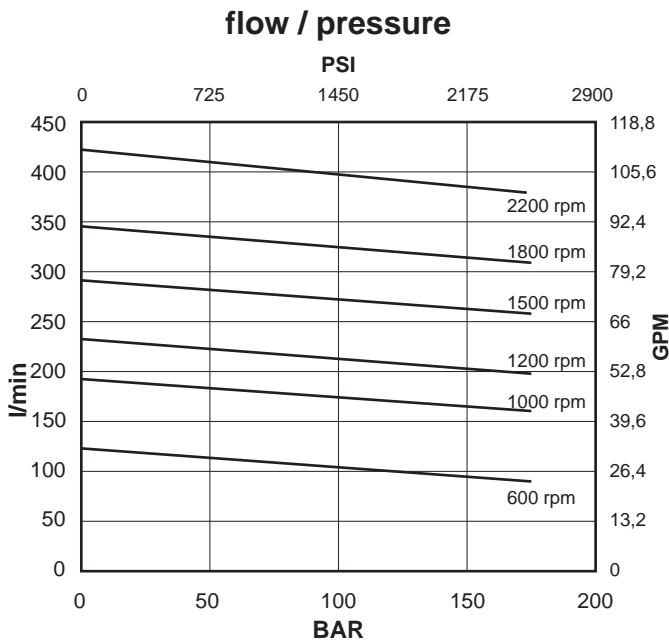

Oil viscosity: 25 c.St.(10W)
 Temperature: 45°C
 Inlet pressure: 0 BAR

Cartridge V01-02

flow / pressure

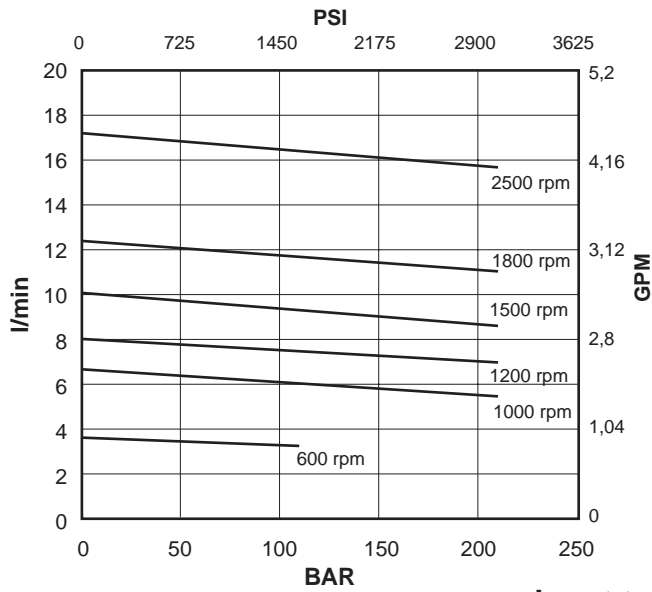

power / pressure

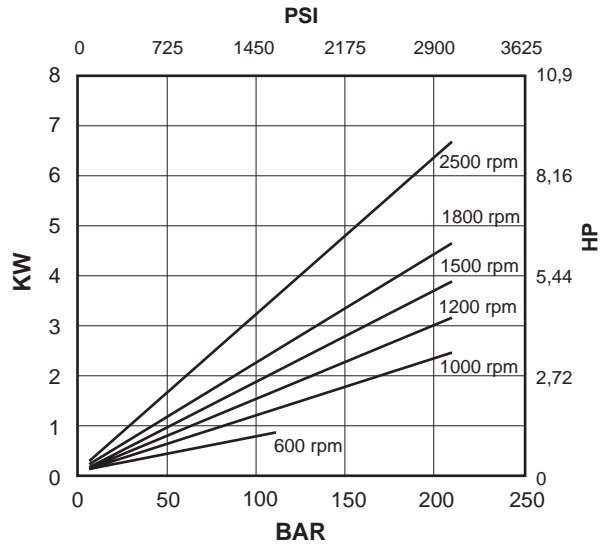

input torque / pressure

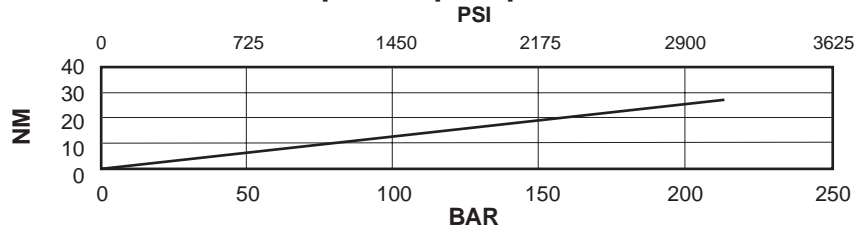

Oil viscosity: 25 c.St.(10W)
Temperature: 45°C
Inlet pressure: 0 BAR

Cartridge V01-05

flow / pressure

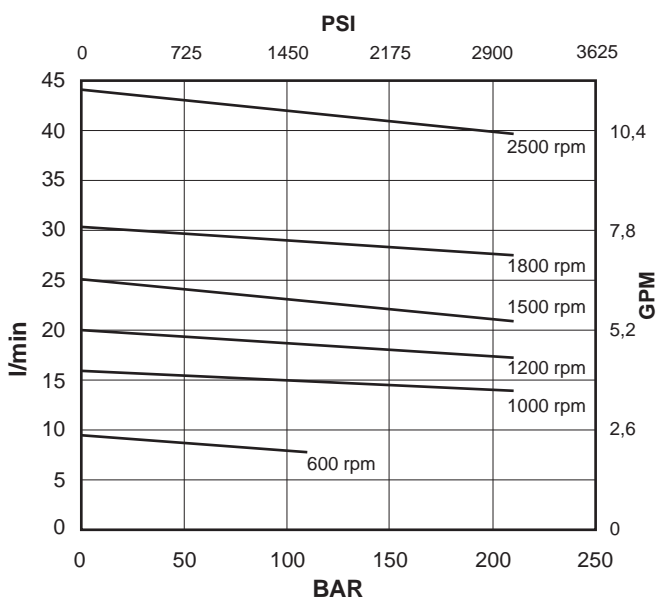

power / pressure

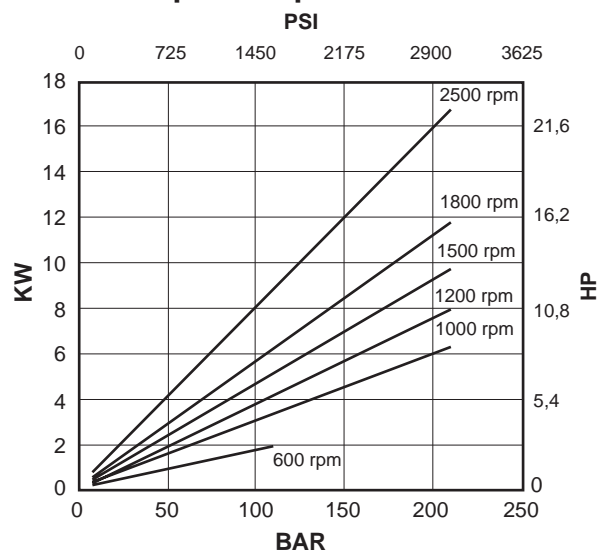

input torque / pressure

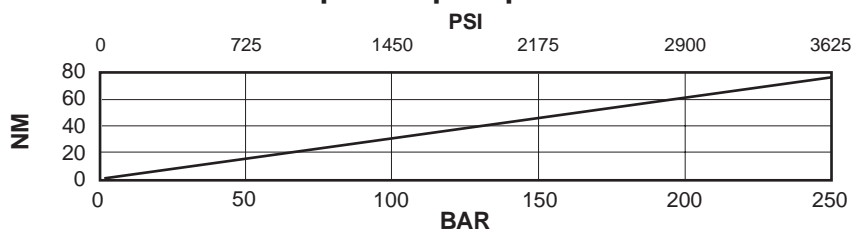

Oil viscosity: 25 c.St.(10W)
Temperature: 45°C
Inlet pressure: 0 BAR

Cartridge V01-08

flow / pressure

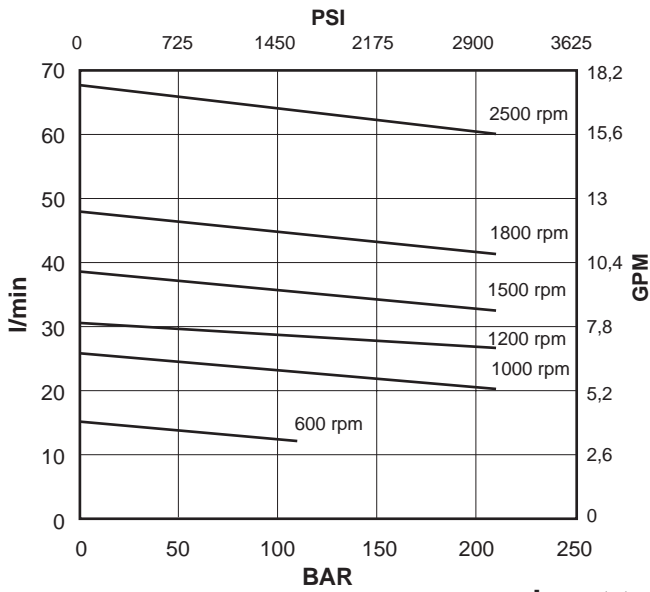

power / pressure

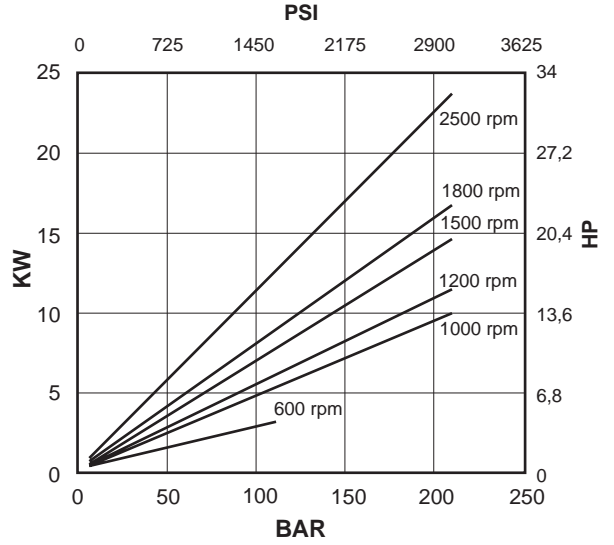

input torque / pressure

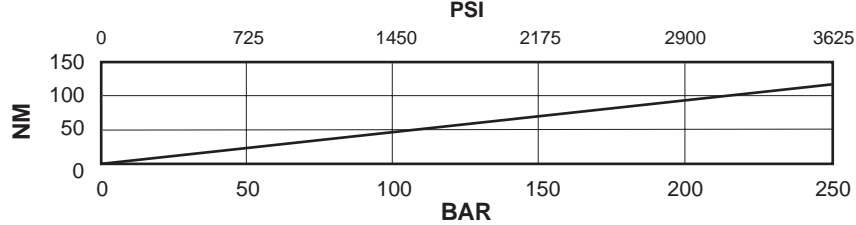

Oil viscosity: 25 c.St.(10W)
Temperature: 45°C
Inlet pressure: 0 BAR

Cartridge V01-09

flow / pressure

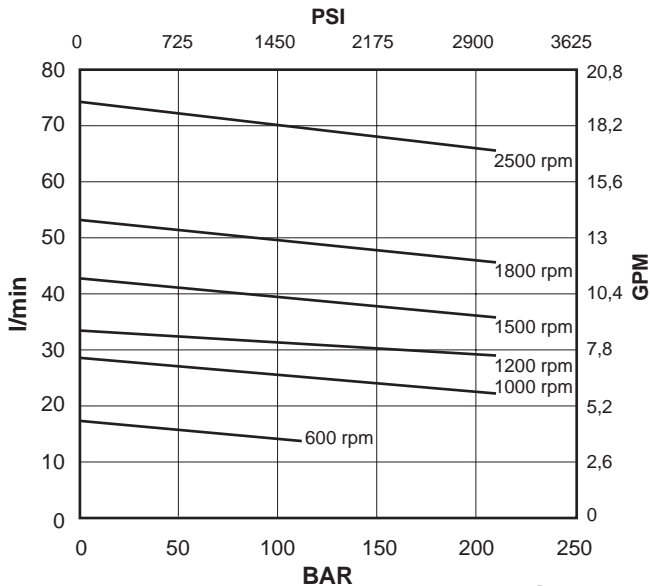

power / pressure

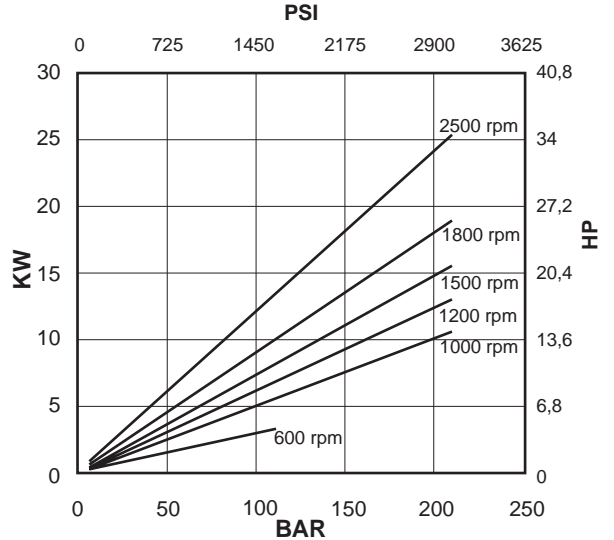

input torque / pressure

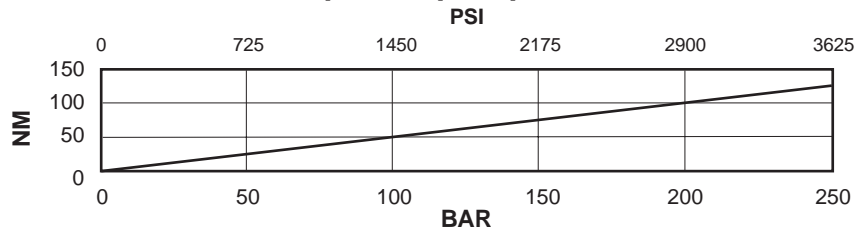

Oil viscosity: 25 c.St.(10W)
Temperature: 45°C
Inlet pressure: 0 BAR

Cover end cartridge V01-11

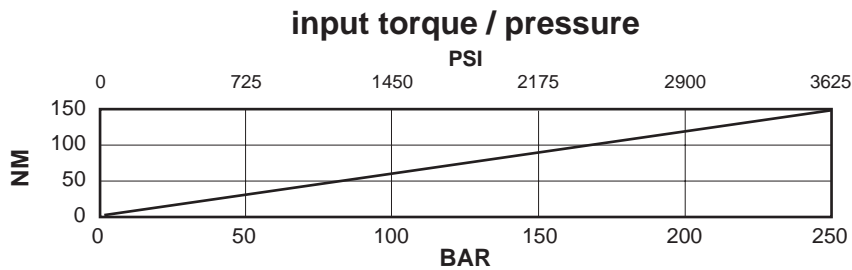
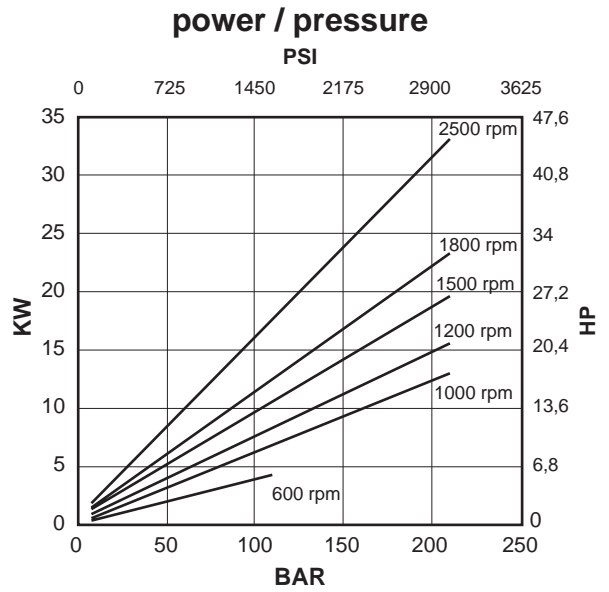
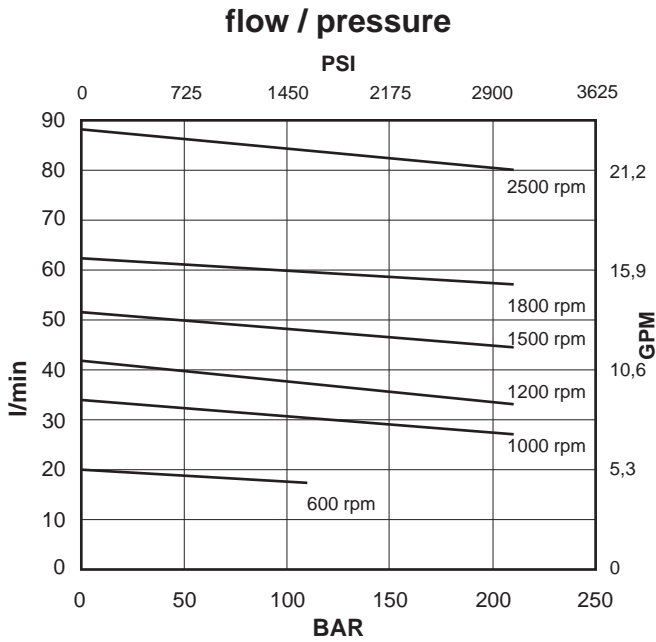

Oil viscosity: 25 c.St.(10W)
 Temperature: 45°C
 Inlet pressure: 0 BAR

Cover end cartridge V01-12

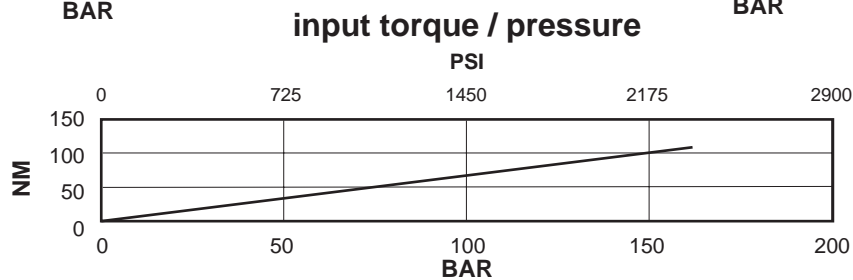
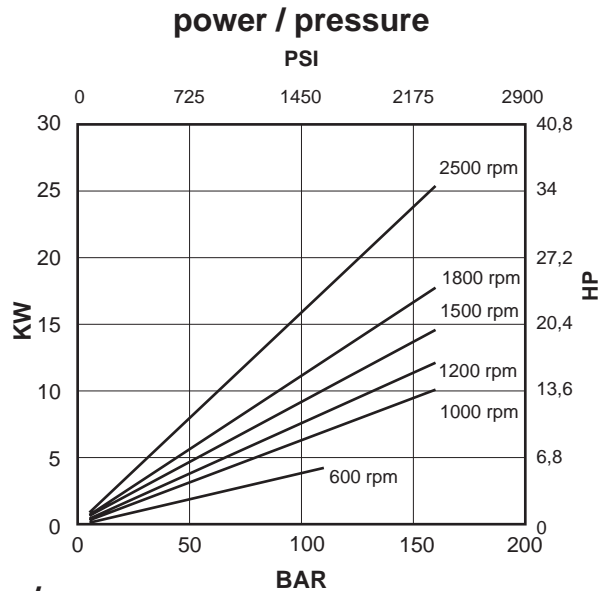
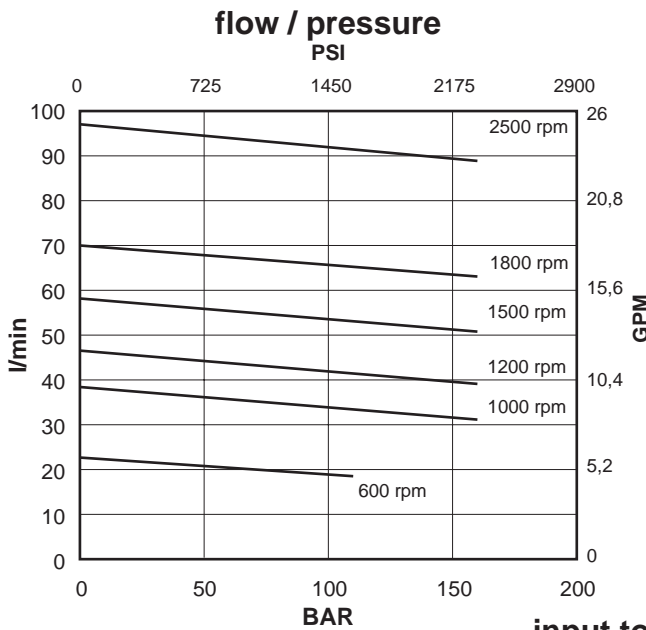

Oil viscosity: 25 c.St.(10W)
 Temperature: 45°C
 Inlet pressure: 0 BAR

Cover end cartridge V01-14

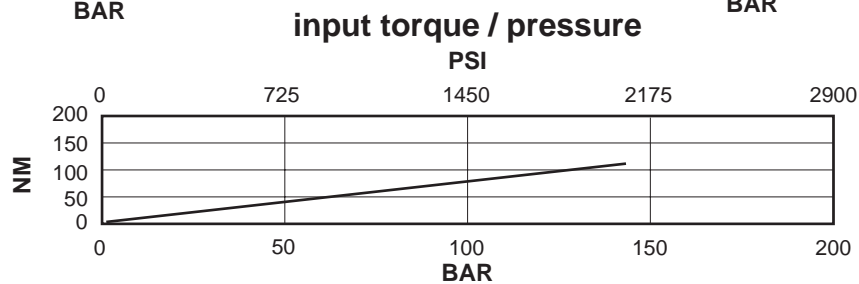
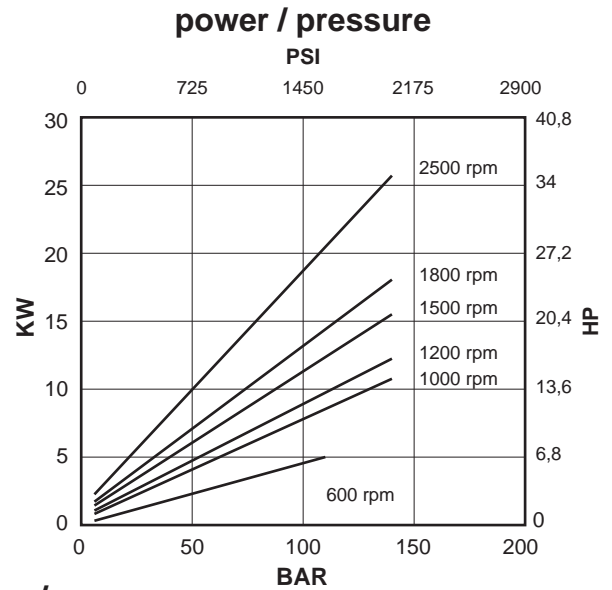
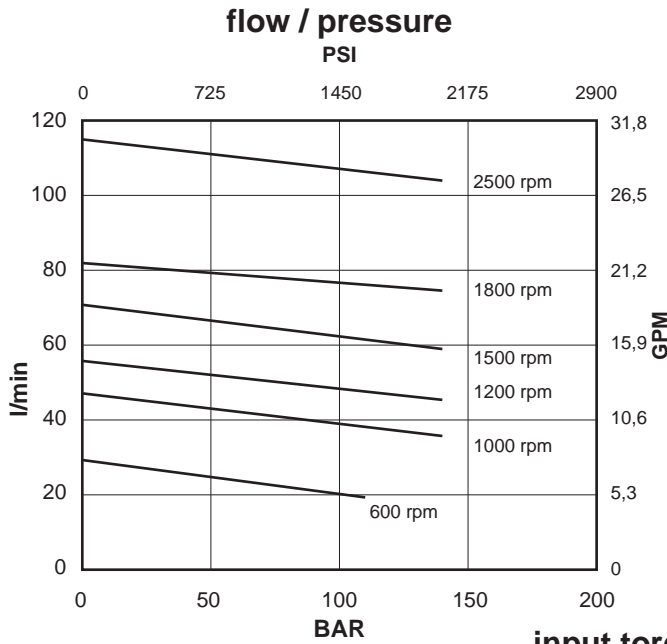

Oil viscosity: 25 c.St.(10W)
 Temperature: 45°C
 Inlet pressure: 0 BAR

Installation dimensions mm (inches)

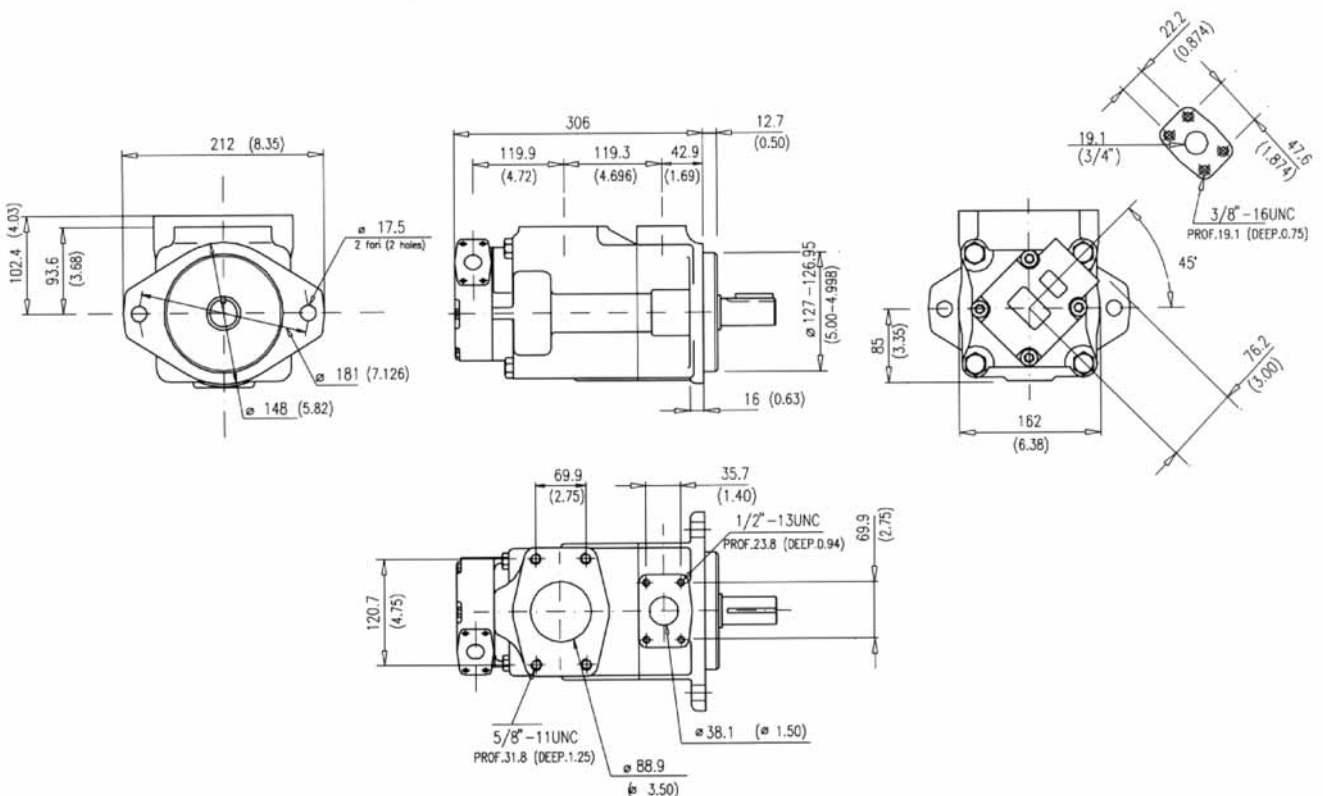

Approx. weight: 43 Kg. (95 lbs.)

Model code breakdown

BV	51	G	**	**	*	*	**	(L)	*	(A)
Pump series		Design							Mounting (omit if not required)	
Pump type										Seals (omit with standard seals and one shaft-seal in NBR) V = seals and shaft-seal in FPM (Viton®) D = standard seals and double shaft-seals in NBR F = seals and double shaft-seals in FPM (Viton®)
Cartridge types										Rotation (viewed from shaft end) L = left hand rotation CCW (omit if CW)
-shaft end		42	47	50	57	60				
-cover end		02	05	08	09	11	12	14		
Body outlet port positions (outlet viewed from cover end)										
A = Outlet opposite end										
B = Outlet 90° CCW from inlet										
C = Outlet in line with inlet										
D = Outlet 90° CW from inlet										
Cover outlet port positions (outlet viewed from cover end)										
A = Outlet 135° CCW from inlet										
B = Outlet 45° CCW from inlet										
C = Outlet 45° CW from inlet										
D = Outlet 135° CW from inlet										
										Shaft end options 01 = Straight with key (standard), 11 = Splined 86 = Heavy duty straight keyed, 90 = Splined SAE C

Shaft options mm (inches)

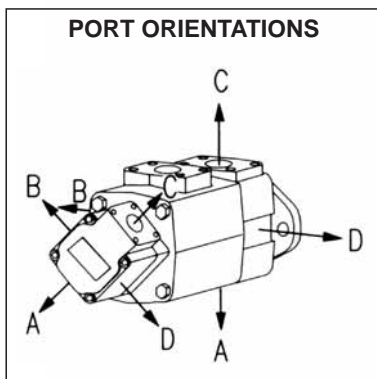
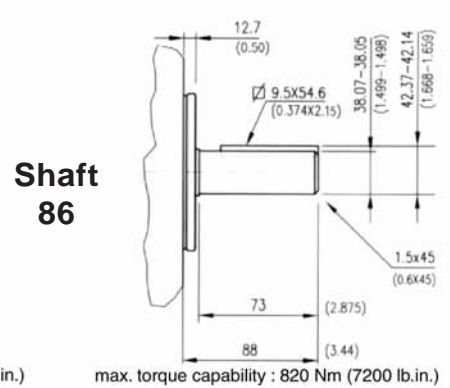
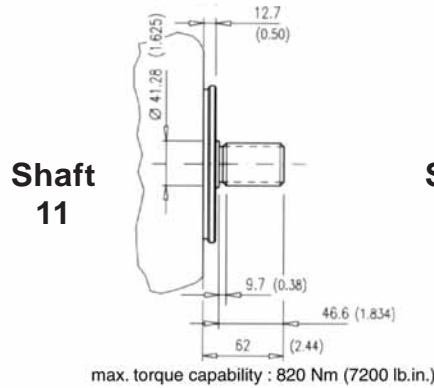
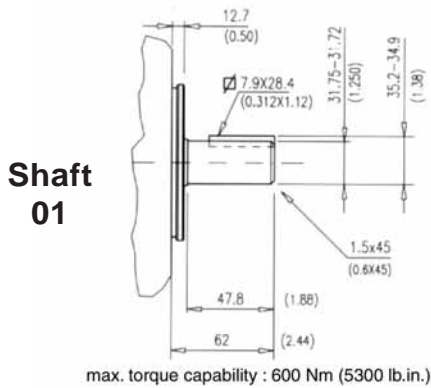

Spline data
(shaft 11 and shaft 90)
Involute side fit (ASA B5.15)

Spline	
Pressure angle	30°
No. of teeth	14
Pitch	12/24
Major dia.	31.60 - 31.50 (1.244 - 1.240)
Pitch dia.	29.634 (1.1667)
Minor dia.	26.99 - 26.66 (1.0627 - 1.05)
Wildhaber	15.68 - 15.73 (0.617 - 0.619)

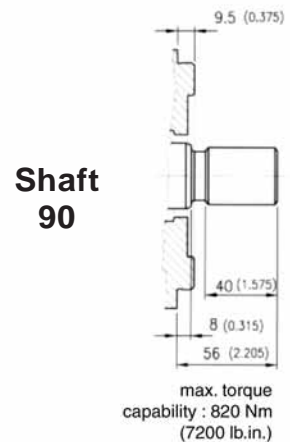

Id. codes of pump components

cover end		Cartridges				Pump rotation
		shaft end				
Series	Model	Part No.	Series	Model	Part No.	
V01	02	V0102000	V05	42	V0542010	right hand
	05	V0105010		47	V0547030	
	08	V0108030		50	V0550050	
	09	V0109050	57	V0557070		
	11	V0111070	60	V0560090		
	12	V0112090				
	14	V0114110				
V01	02	V0102005	V05	42	V0542020	left hand
	05	V0105020		47	V0547040	
	08	V0108040		50	V0550060	
	09	V0109060		57	V0557080	
	11	V0111080		60	V0560100	
	12	V0112100				
	14	V0114120				

Shaft kit	
Model	Part No.
01	M8510601
11	M8510611
86	M8510686
90	M8510690

Shaft		Key	
Model	Part No.	Part No.	Part No.
01	K5101000	M8050100	
11	K5111000	-	
86	K5186000	M8058600	
90	K5190000	-	

Shaft kit	
Model	Part No.
01	M8510601
11	M8510611
86	M8510686
90	M8510690

Body	
Part No.	Part No.
M8050250	

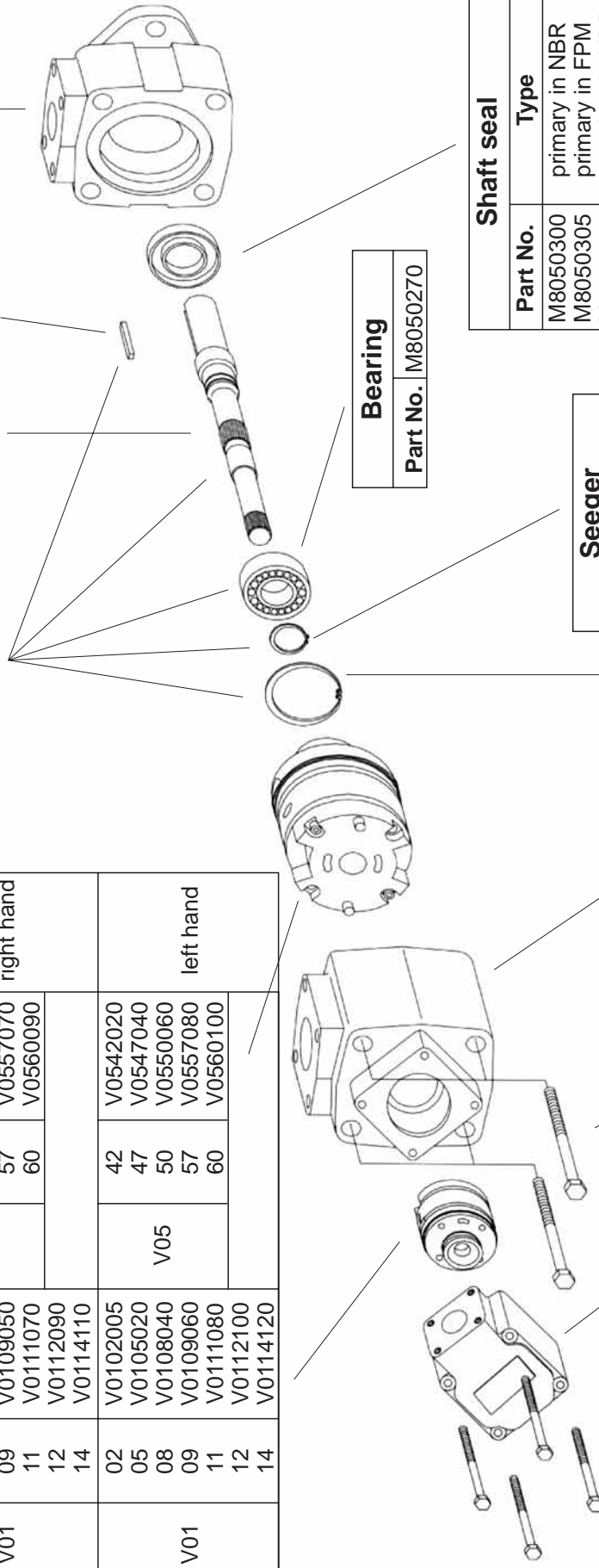

Shaft seal	
Part No.	Type
M8050300	primary in NBR
M8050305	primary in FPM
M8050301	secondary in NBR
M8050306	secondary in FPM

Bearing	
Part No.	Part No.
M8050270	

Seeger	
Part No.	Part No.
M8050290	

Inlet body	
Part No.	Part No.
M8050390	

Cover	
Part No.	Part No.
M8020120	

Screw	
Part No.	Part No.
M8050320	
Torque to 398 Nm (3550 lb. in.)	

Screw	
Part No.	Part No.
M8020420	
Torque to 70 Nm (624 lb. in.)	

Pump seal kit		
Part No.	Parts	Type
M8510500	seals + 1 shaft seal	NBR
M8510501	seals + 2 shaft seals	NBR
M8510503	seals + 1 shaft seal	FPM (Viton®)
M8510504	seals + 2 shaft seals	FPM (Viton®)

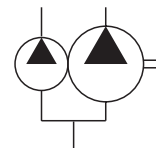
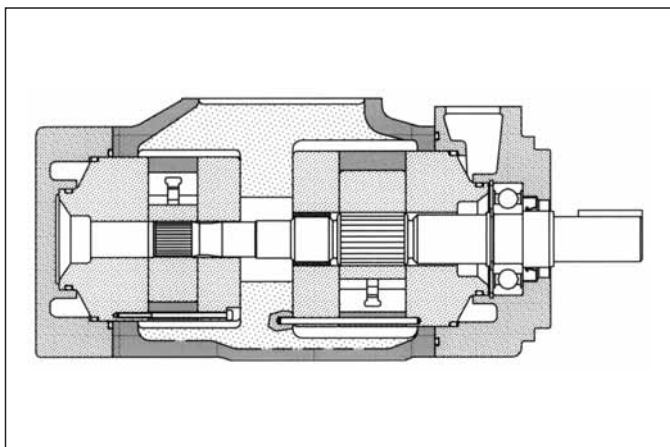

General description

Fixed displacement vane pump, hydraulically balanced, with capacity determined by the cartridges used and the speed of rotation. The pump is available in several versions with rated capacities from 211 to 309 l/min (from 54 to 81 gpm) at 1200 rpm and 7 bar.

Technical characteristics

Cartridge model	Geometric displacement		Rated capacity at 1200 rpm 7 bar		Rated capacity at 1500 rpm 7 bar		Maximum pressure with mineral oil		Speed range rpm	
	cm ³ /g	(in ³ /r)	l/min	(gpm)	l/min	(gpm)	bar	(psi)	min	max
shaft end										
V05-42	138,6	(8.46)	164	(42)	203,4	(53.7)	175	(2538)	600	1800
V05-47	153,5	(9.4)	180	(47)	222,7	(58.8)	175	(2538)	600	1800
V05-50	162,2	(9.9)	189	(50)	234	(61.8)	175	(2538)	600	1800
V05-57	183,4	(11.2)	217	(57)	267	(71.2)	175	(2538)	600	1800
V05-60	193,4	(11.8)	230	(60)	285	(75.3)	175	(2538)	600	1800
cover end										
V02-12	40,1	(2.45)	46,9	(12)	58,8	(15.5)	175	(2538)	600	1800
V02-14	45,4	(2.77)	52,7	(14)	65,7	(17.4)	175	(2538)	600	1800
V02-17	55,2	(3.37)	64,2	(17)	80,2	(21.2)	175	(2538)	600	1800
V02-19	60,0	(3.66)	71,0	(19)	88,7	(23.4)	175	(2538)	600	1800
V02-21	67,5	(4.12)	79,0	(21)	99,8	(26.4)	175	(2538)	600	1800

Hydraulic fluids: antiwear high quality mineral oils or fire resistant fluid having same lubrication capacities of the mineral oil.

Viscosity range (with mineral oil): from 13 to 860 cSt. (13 to 54 cSt. recommended).

Filtration: for the inlet - 149 micron abs., for the return line - 25 micron abs. or better (with synthetic fluids: for the return line - 10 micron abs. or better).

Inlet pressure: (with mineral oil): from -0,17 to +1,4 bar (-2.5 to + 20 psi)

Operating temperature: with mineral oil -10°C +70°C (+30°C to +60°C recommended), with water based fluids +15°C to +50°C.

Drive: direct and coaxial by means of a flexible coupling.

Main operating data

max pressure / hydraulic fluid

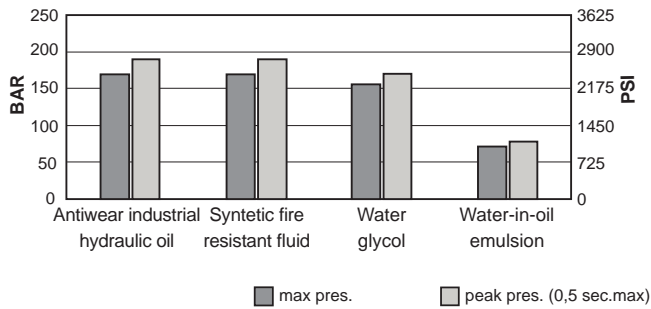

max speed / hydraulic fluid (with 0 bar in the intake pipe)

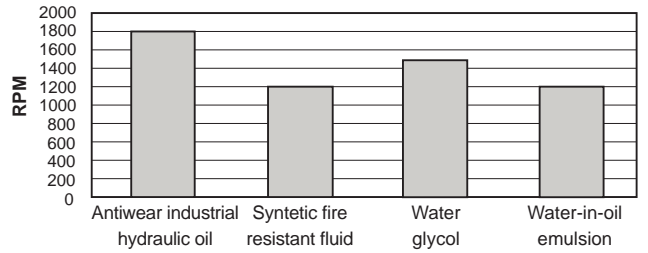

If the intake pressure is not zero bar, use the graph below to find the percentage correction factor to apply to the maximum speed

max speed / intake pipe pressure

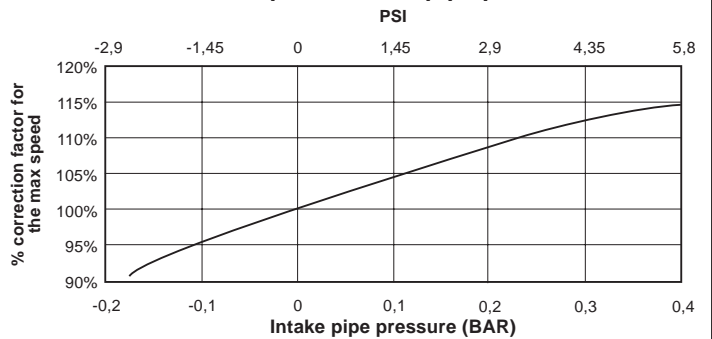

Sound level at 138 bar (2000 psi)

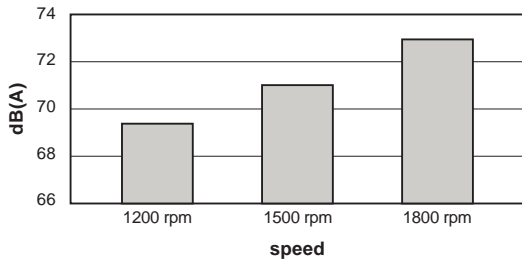

flow / pressure

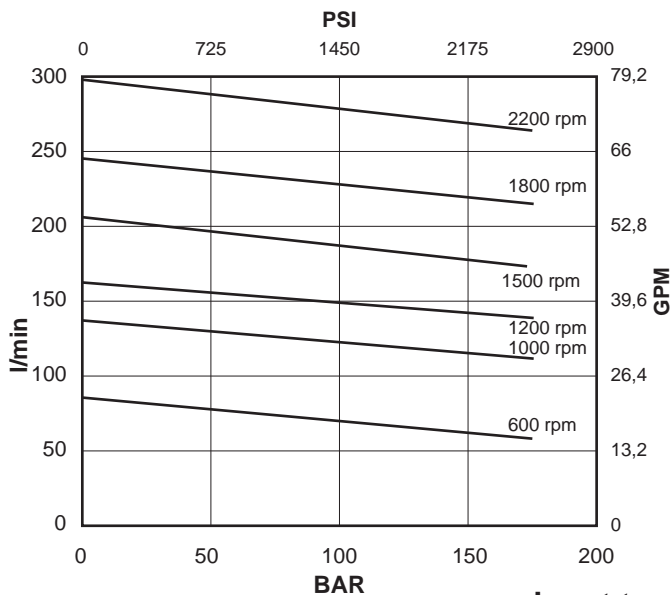

Shaft end cartridge V05-42

power / pressure

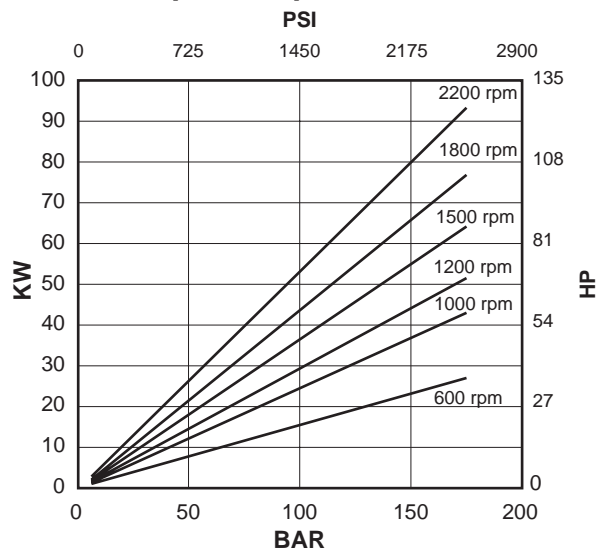

input torque / pressure

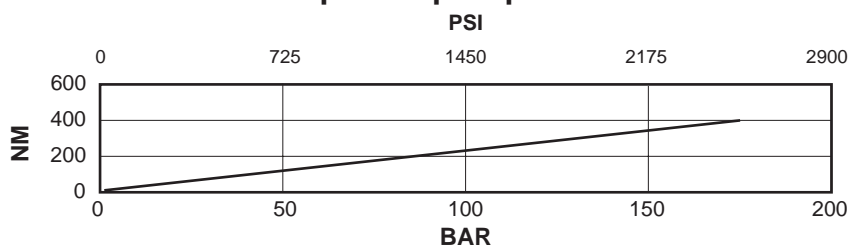

Oil viscosity: 25 c.St.(10W)
 Temperature: 45°C
 Inlet pressure: 0 BAR

Shaft end cartridge V05-47

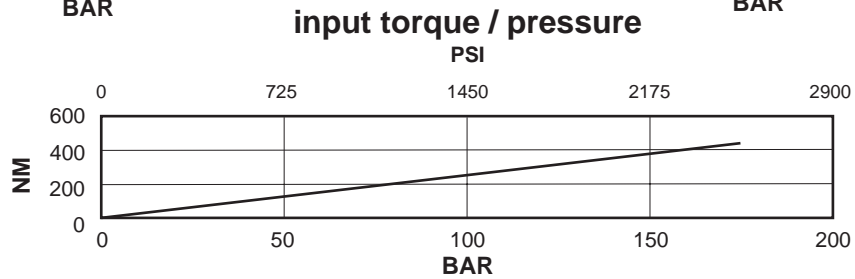
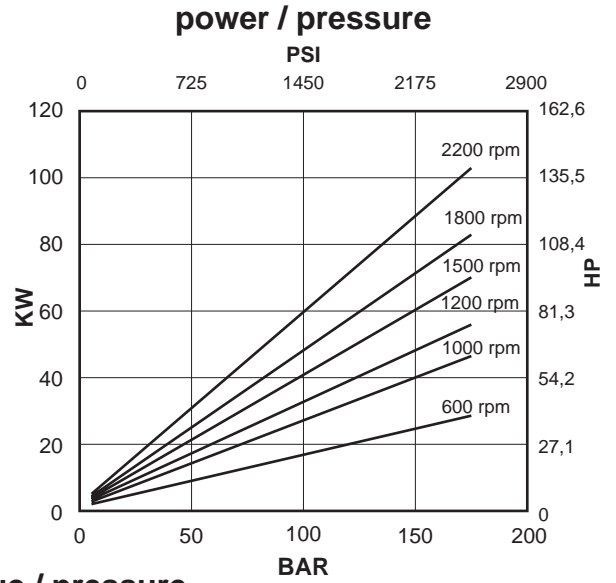
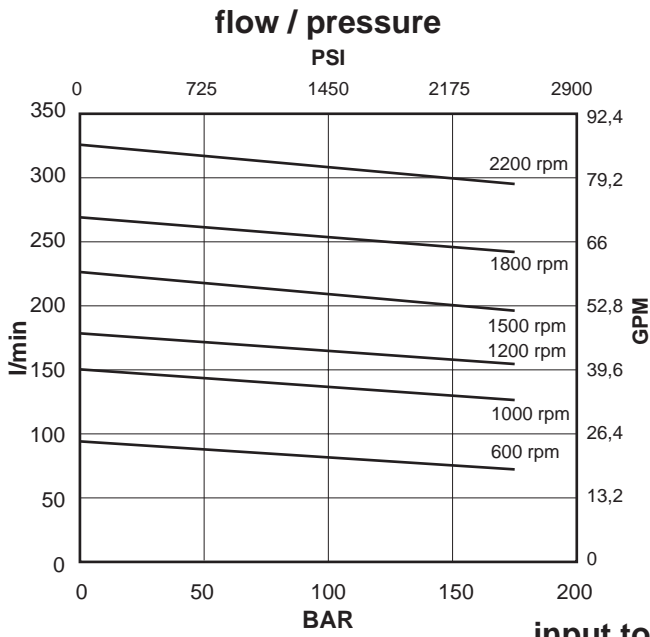

Oil viscosity: 25 c.St.(10W)
 Temperature: 45°C
 Inlet pressure: 0 BAR

Shaft end cartridge V05-50

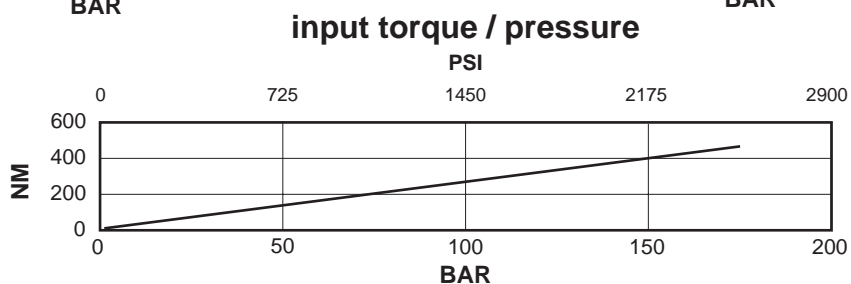
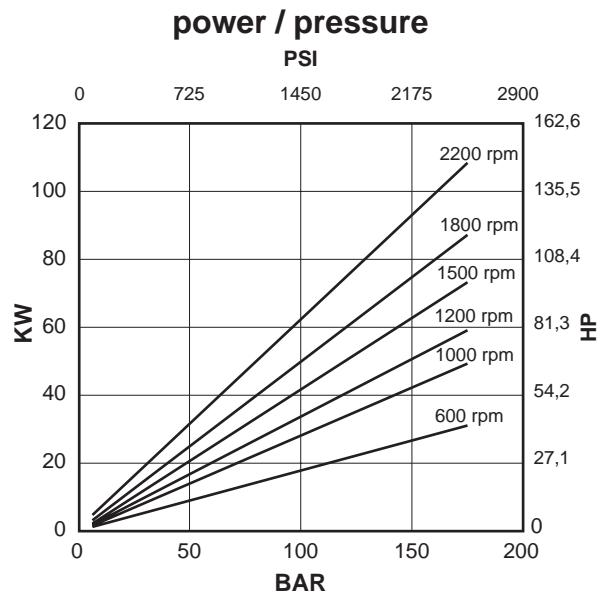
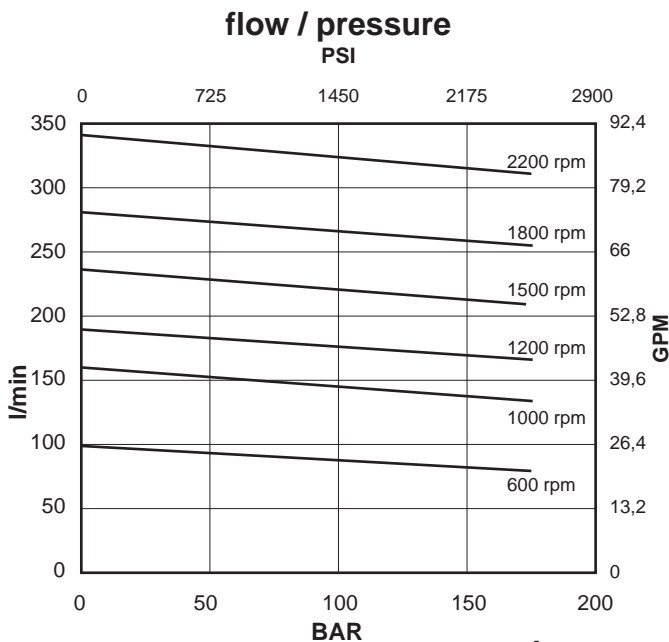

Oil viscosity: 25 c.St.(10W)
 Temperature: 45°C
 Inlet pressure: 0 BAR

Shaft end cartridge V05-57

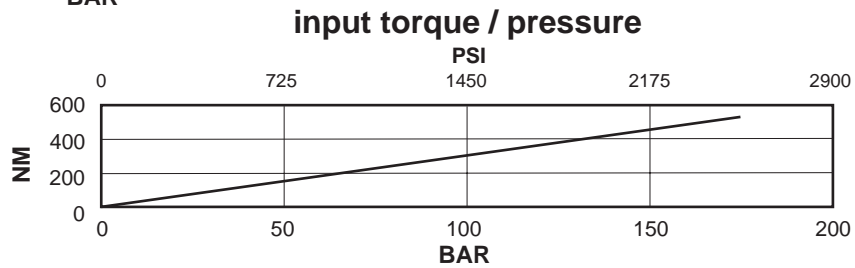
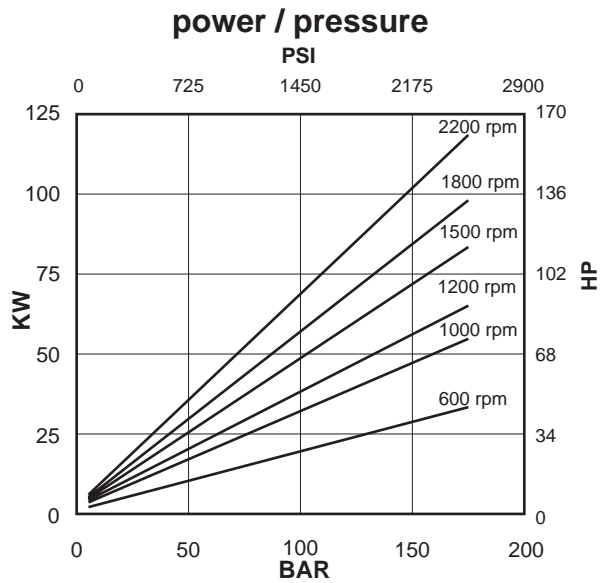
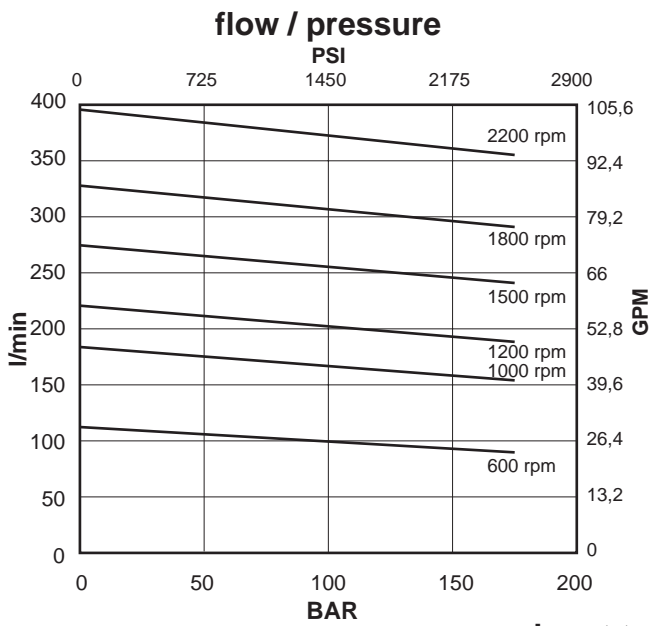

Oil viscosity: 25 c.St.(10W)
 Temperature: 45°C
 Inlet pressure: 0 BAR

Shaft end cartridge V05-60

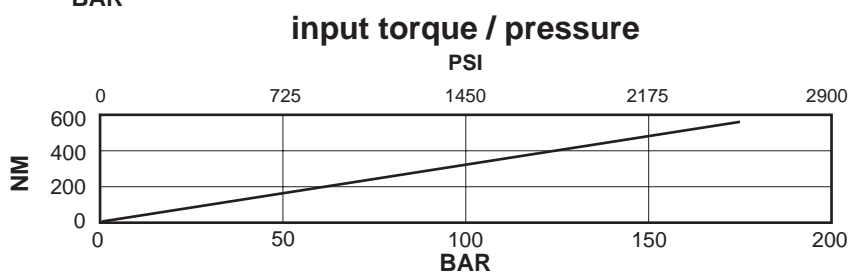
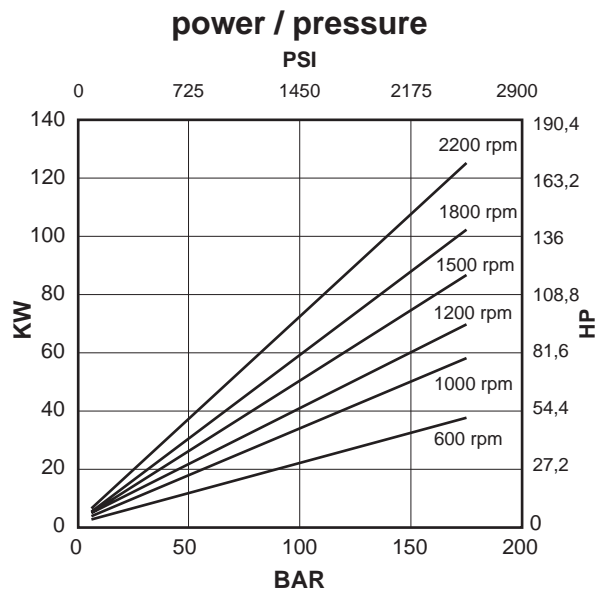
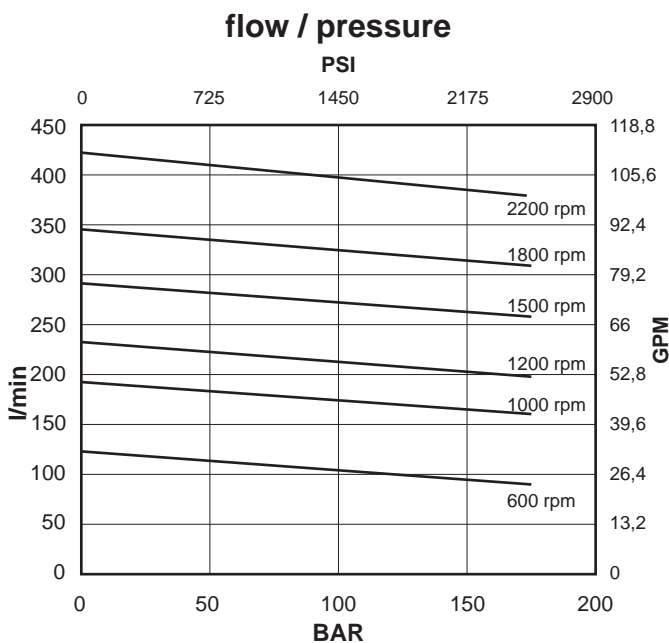

Oil viscosity: 25 c.St.(10W)
 Temperature: 45°C
 Inlet pressure: 0 BAR

Cover end cartridge V02-12

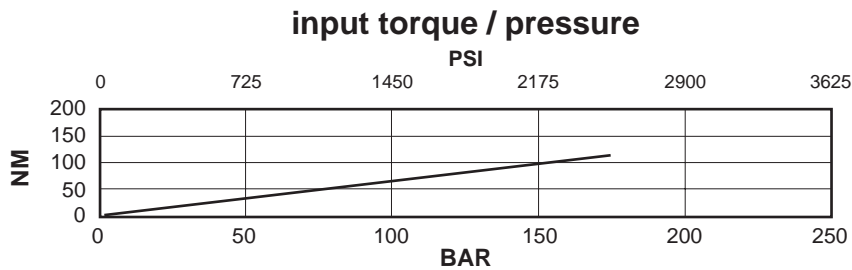
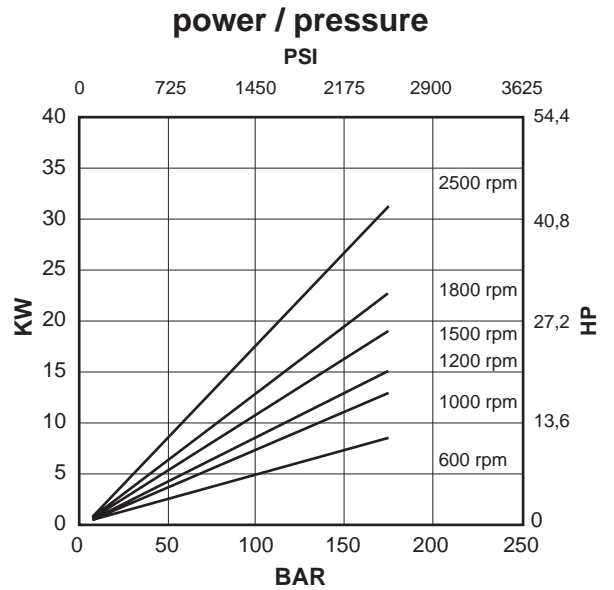
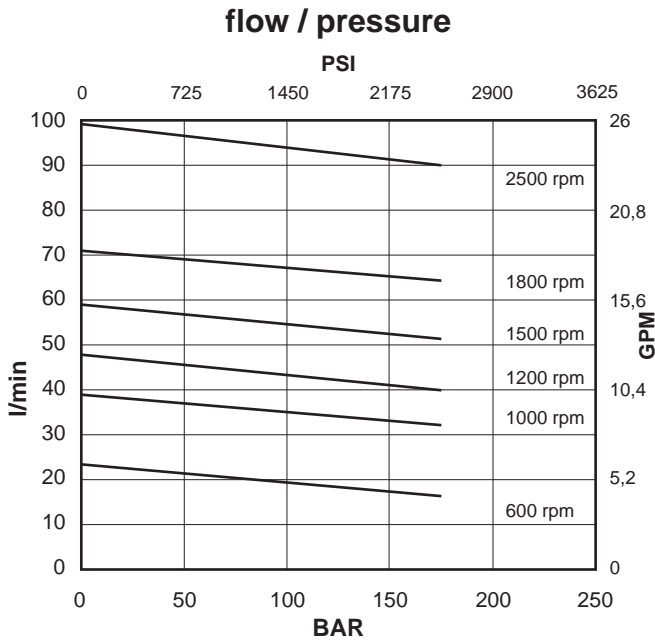

Oil viscosity: 25 c.St.(10W)
 Temperature: 45°C
 Inlet pressure: 0 BAR

Cover end cartridge V02-14

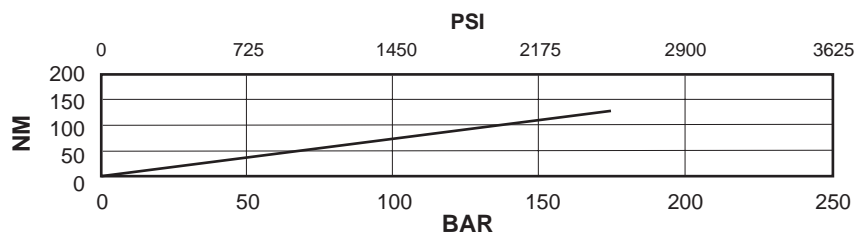
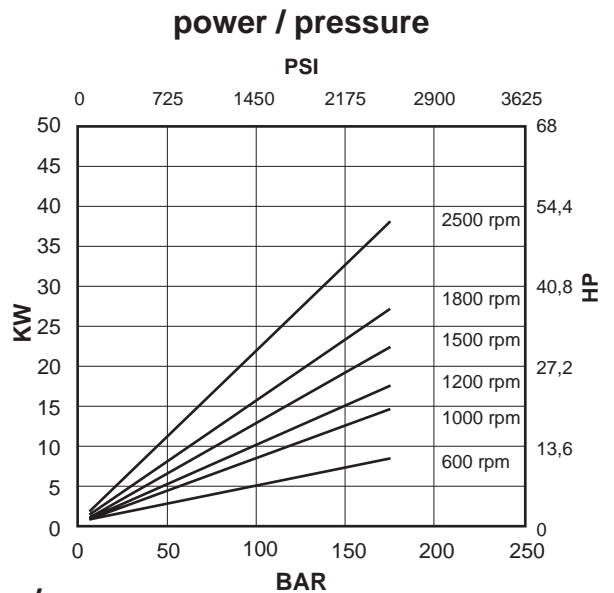
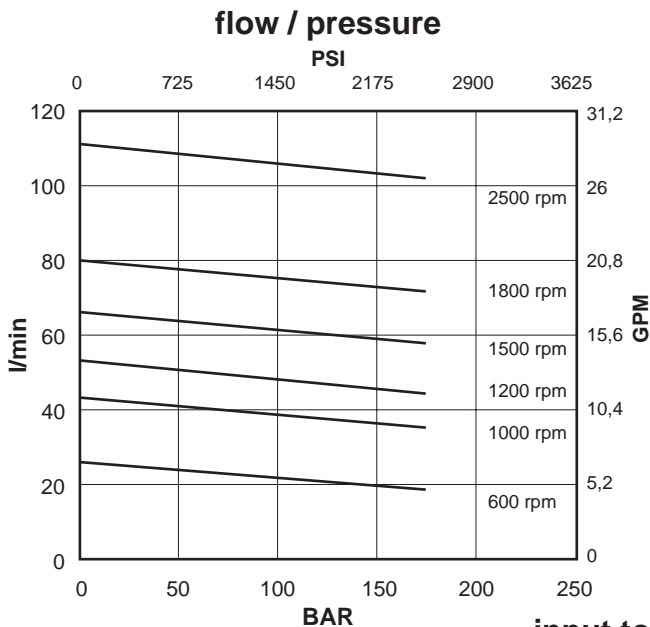

Oil viscosity: 25 c.St.(10W)
 Temperature: 45°C
 Inlet pressure: 0 BAR

Cover end cartridge V02-17

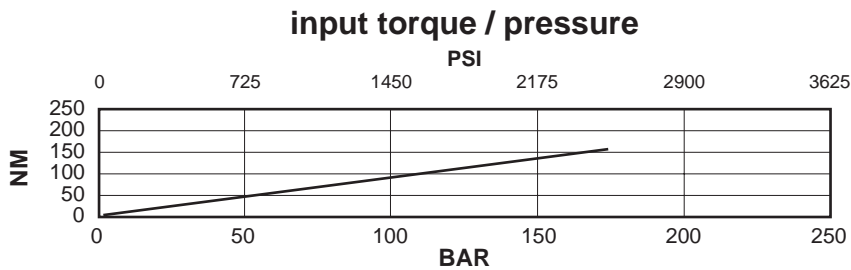
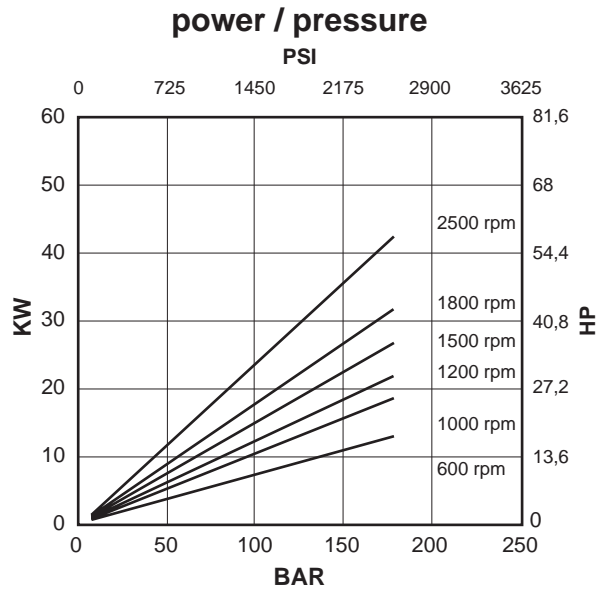
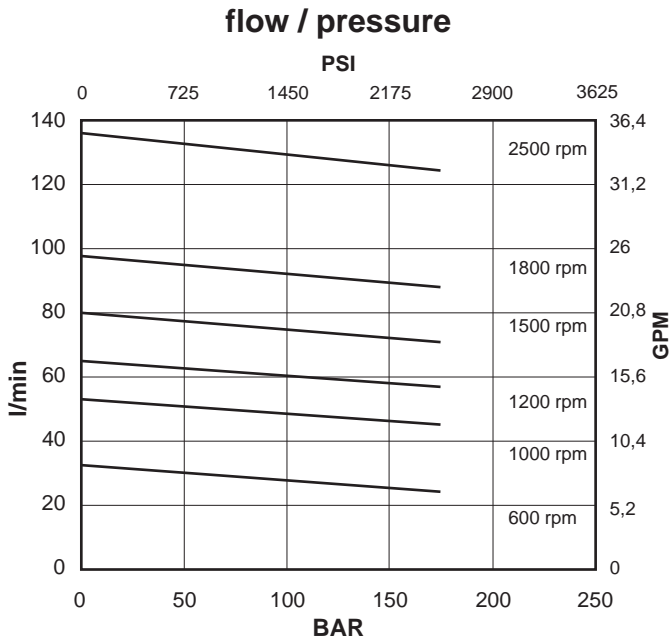

Oil viscosity: 25 c.St.(10W)
 Temperature: 45°C
 Inlet pressure: 0 BAR

Cover end cartridge V02-19

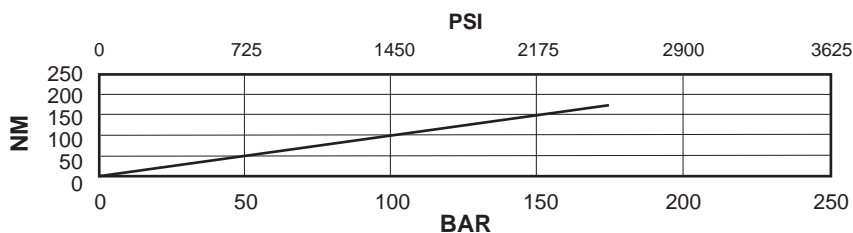
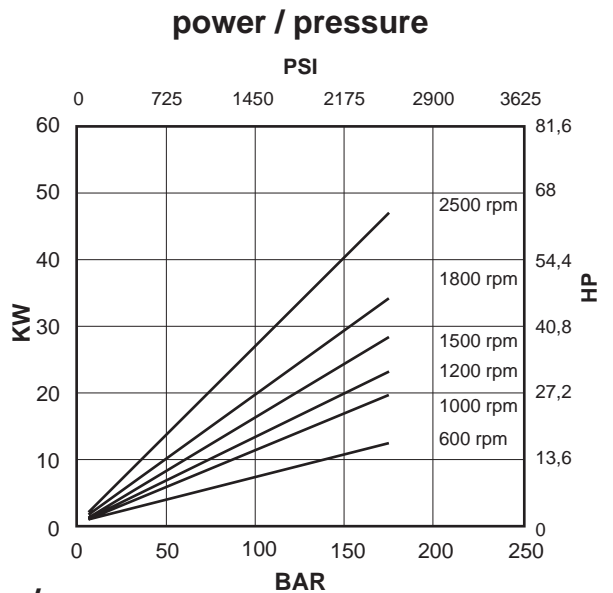
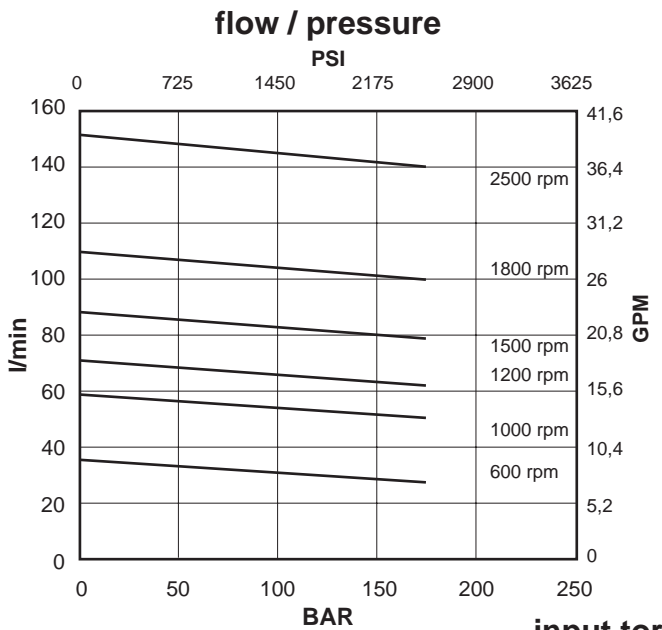

Oil viscosity: 25 c.St.(10W)
 Temperature: 45°C
 Inlet pressure: 0 BAR

flow / pressure

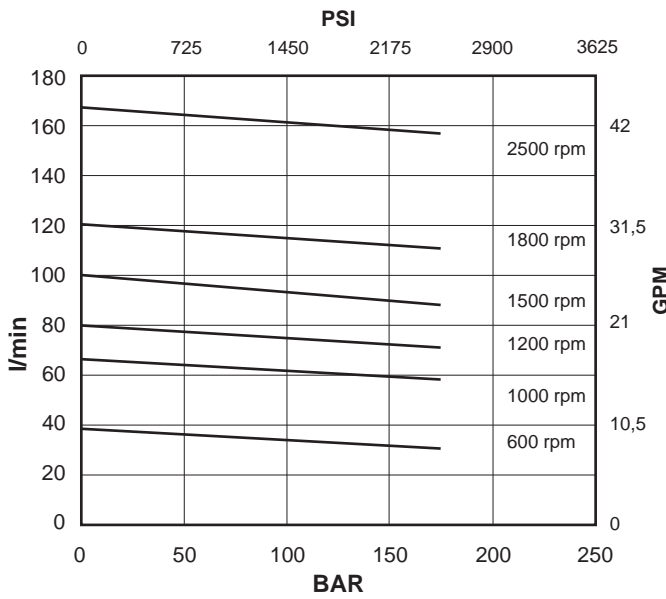

Cover end cartridge V02-21

power / pressure

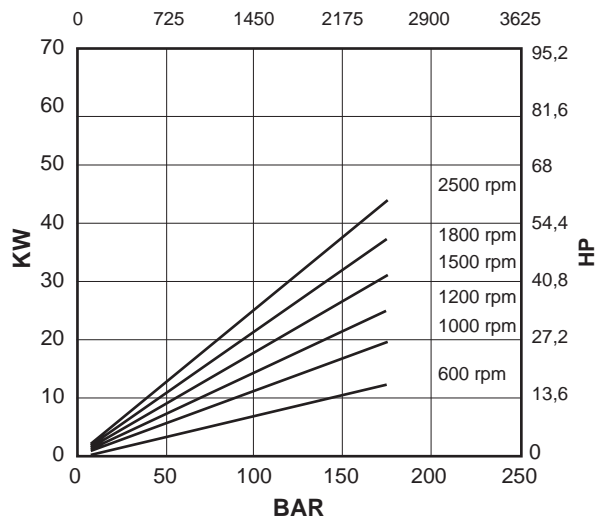

input torque / pressure

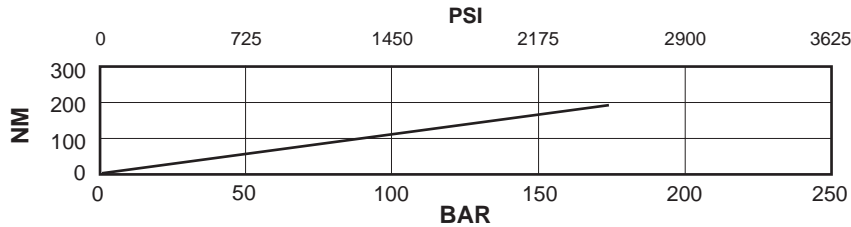

Oil viscosity: 25 c.St.(10W)
Temperature: 45°C
Inlet pressure: 0 BAR

Installation dimensions mm (inches)

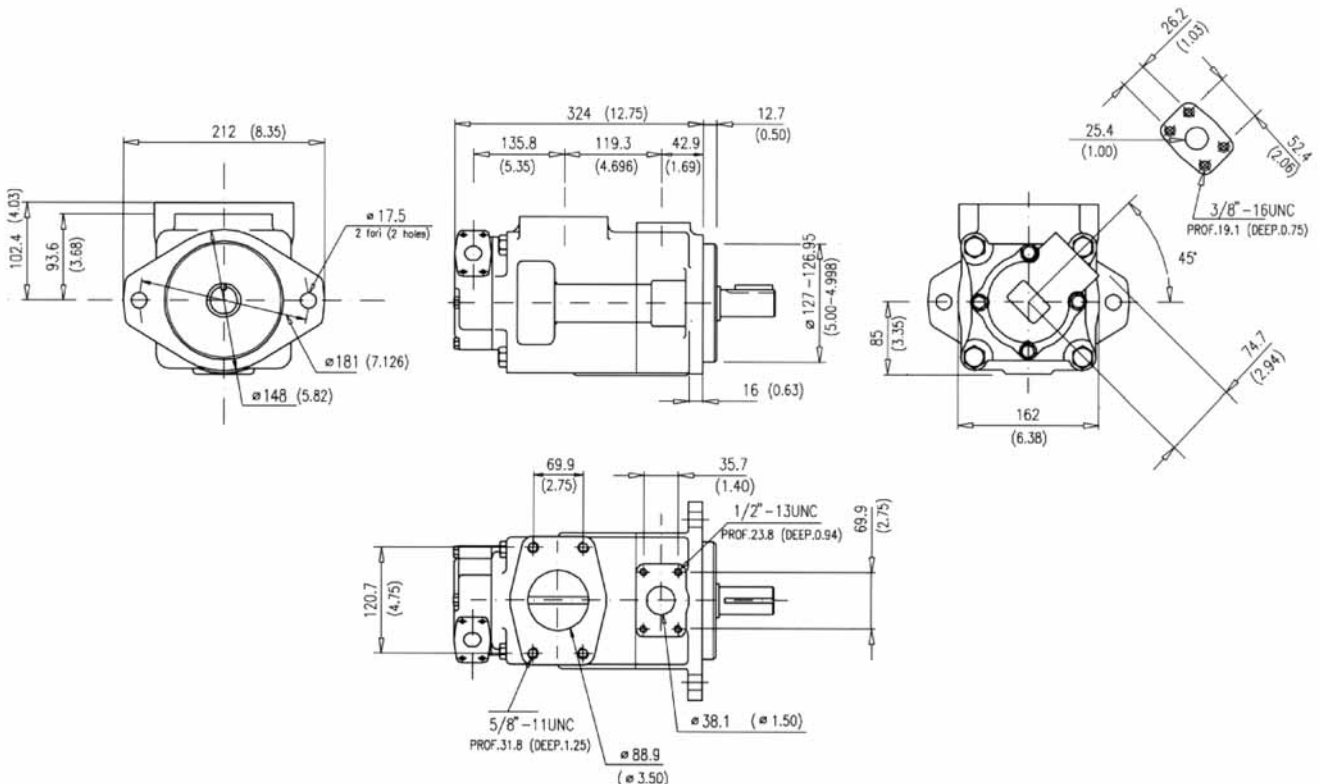

Approx. weight: 46 Kg. (101 lbs.)

Model code breakdown

BV	52	G	**	**	*	*	**	(L)	*	(A)	
Pump series		Design								Mounting (omit if not required)	
Pump type							Seals (omit with standard seals and one shaft-seal in NBR) V = seals and shaft-seal in FPM (Viton®) D = standard seals and double shaft-seals in NBR F = seals and double shaft-seals in FPM (Viton®)				
Cartridge types							Rotation (viewed from shaft end) L = left hand rotation CCW (omit if CW)				
-shaft end 42 47 50 57 60											
-cover end 12 14 17 19 21											
Body outlet port positions (outlet viewed from cover end)											
A = Outlet opposite end											
B = Outlet 90° CCW from inlet											
C = Outlet in line with inlet											
D = Outlet 90° CW from inlet											
Cover outlet port positions (outlet viewed from cover end)											
A = Outlet 135° CCW from inlet											
B = Outlet 45° CCW from inlet											
C = Outlet 45° CW from inlet											
D = Outlet 135° CW from inlet											
							Shaft end options 01 = Straight with key (standard), 11 = Splined 86 = Heavy duty straight keyed, 90 = Splined SAE C				

Shaft options mm (inches)

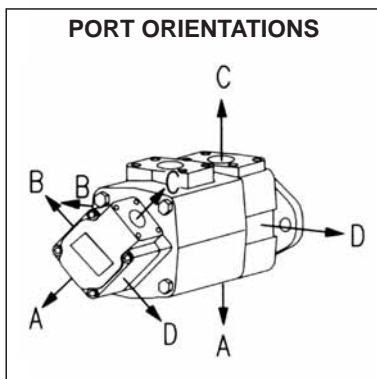
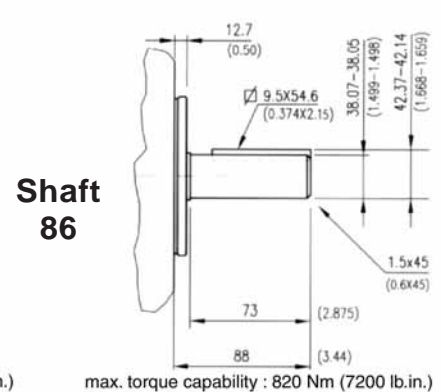
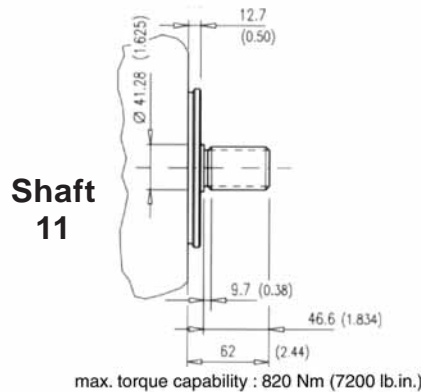
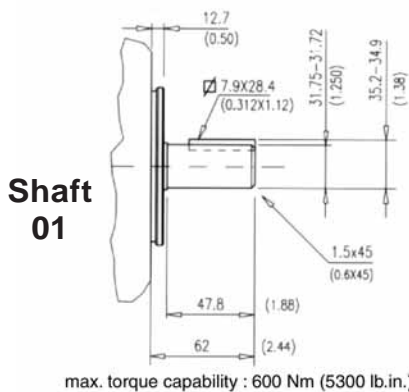

Spline data
(shaft 11 and shaft 90)
Involute side fit (ASA B5.15)

Spline		
Pressure angle	30°	
No. of teeth	14	
Pitch	12/24	
Major dia.	31.60 - 31.50	(1.244 - 1.240)
Pitch dia.	29.634	(1.1667)
Minor dia.	26.99 - 26.66	(1.0627 - 1.05)
Wildhaber	15.68 - 15.73	(0.617 - 0.619)

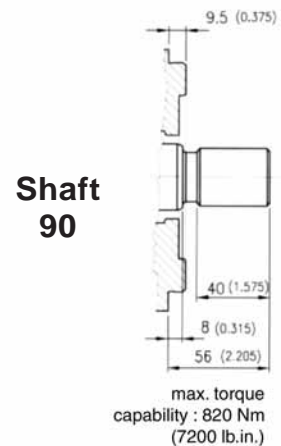

Id. codes of pump components

Cartridges				Pump rotation		
Series	cover end		shaft end			
	Model	Part No.	Series	Model	Part No.	
V02	12	V0212010	V05	42	V0542010	right hand
	14	V0214050		47	V0547030	
	17	V0217090		50	V0550050	
	19	V0219130		57	V0557070	
V02	21	V0221170	V05	60	V0560090	left hand
	12	V0212020		42	V0542020	
	14	V0214060		47	V0547040	
	17	V0217100		50	V0550060	
	19	V0219140		57	V0557080	
21	V0221180	60	V0560100			

Shaft kit	
Model	Part No.
01	M8520601
11	M8520611
86	M8520686
90	M8520690

Shaft	
Model	Part No.
01	K5201000
11	K5211000
86	K5286000
90	K5290000

Body	
Part No.	M8050250

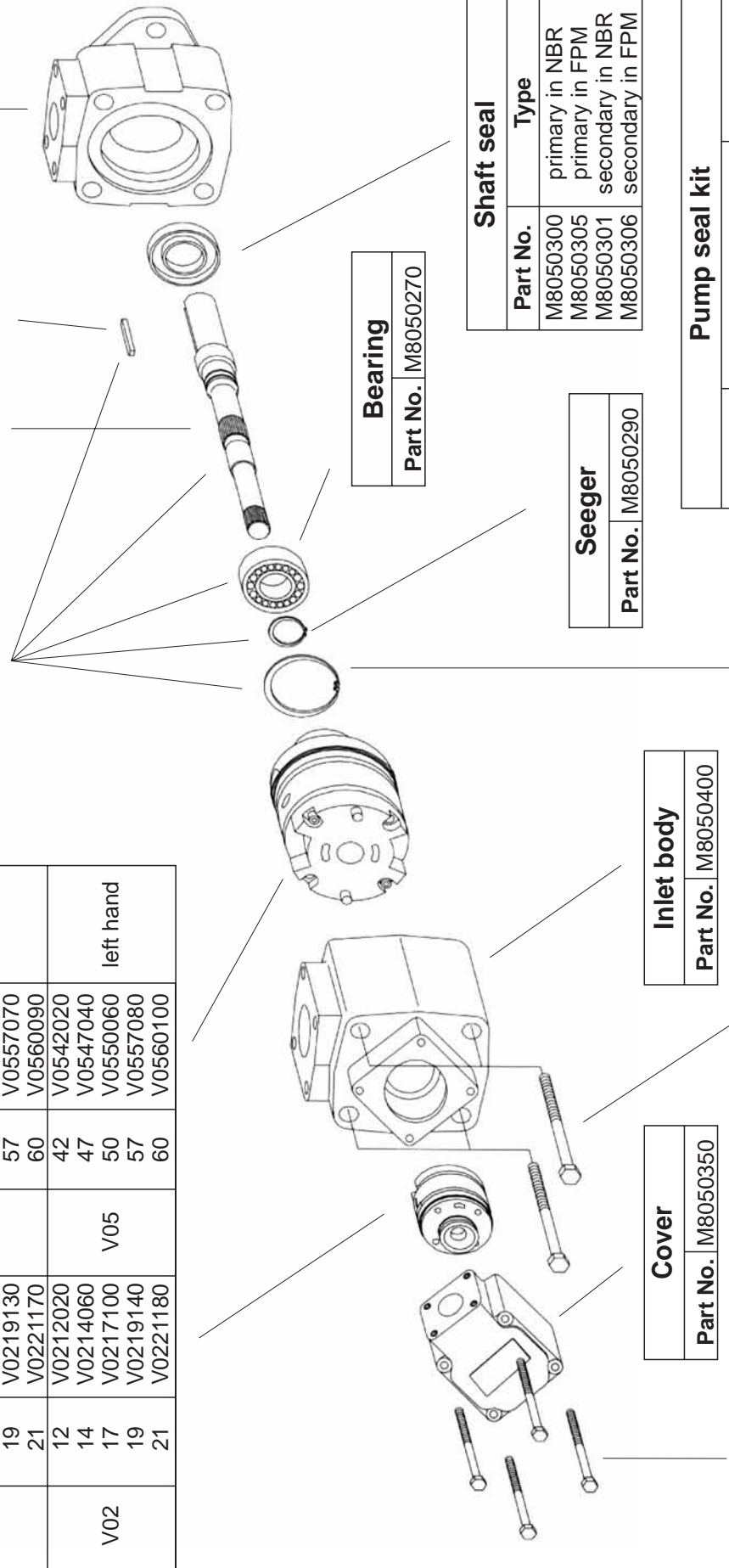

Bearing	
Part No.	M8050270

Seeger	
Part No.	M8050290

Shaft seal	
Part No.	Type
M8050300	primary in NBR
M8050305	primary in FPM
M8050301	secondary in NBR
M8050306	secondary in FPM

Inlet body	
Part No.	M8050400

Cover	
Part No.	M8050350

Screw	
Part No.	M8040230
Torque to 102 Nm (910 lb. in.)	

Screw	
Part No.	M8050330
Torque to 398 Nm (3550 lb. in.)	

Seeger	
Part No.	M8050280

Pump seal kit		
Part No.	Parts	Type
M8520500	seals + 1 shaft seal	NBR
M8520501	seals + 2 shaft seals	NBR
M8520503	seals + 1 shaft seal	FPM (Viton®)
M8520504	seals + 2 shaft seals	FPM (Viton®)

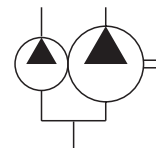
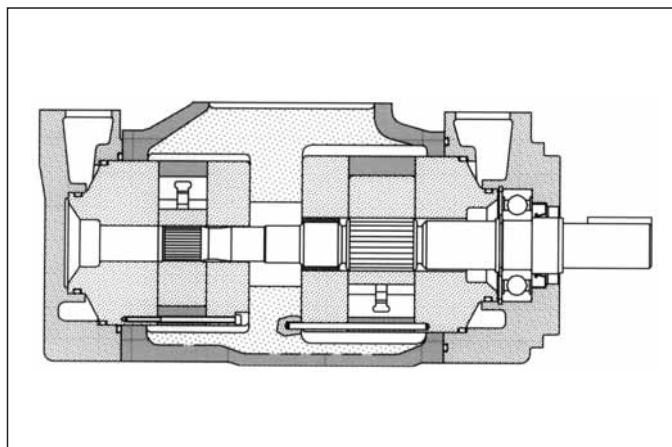

General description

Fixed displacement vane pump, hydraulically balanced, with capacity determined by the cartridges used and the speed of rotation. The pump is available in several versions with rated capacities from 244 to 370 l/min (from 63 to 98 gpm) at 1200 rpm and 7 bar.

Technical characteristics

Cartridge model	Geometric displacement		Rated capacity at 1200 rpm 7 bar		Rated capacity at 1500 rpm 7 bar		Maximum pressure with mineral oil		Speed range rpm	
	cm ³ /g	(in ³ /r)	l/min	(gpm)	l/min	(gpm)	bar	(psi)	min	max
shaft end										
V05-42	138,6	(8.46)	164	(42)	203,4	(53.7)	175	(2538)	600	1800
V05-47	153,5	(9.4)	180	(47)	222,7	(58.8)	175	(2538)	600	1800
V05-50	162,2	(9.9)	189	(50)	234	(61.8)	175	(2538)	600	1800
V05-57	183,4	(11.2)	217	(57)	267	(71.2)	175	(2538)	600	1800
V05-60	193,4	(11.8)	230	(60)	285	(75.3)	175	(2538)	600	1800
cover end										
V04-21	69,0	(4.2)	79,5	(21)	101,4	(26.8)	175	(2538)	600	1800
V04-25	81,6	(5)	94,0	(25)	120,1	(31.7)	175	(2538)	600	1800
V04-30	97,7	(6)	113,8	(30)	141,2	(37.3)	175	(2538)	600	1800
V04-35	112,7	(6.9)	131,6	(35)	167,2	(44.1)	175	(2538)	600	1800
V04-38	121,6	(7.4)	139,9	(38)	177,3	(46.8)	175	(2538)	600	1800

Hydraulic fluids: antiwear high quality mineral oils or fire resistant fluid having same lubrication capacities of the mineral oil.

Viscosity range (with mineral oil): from 13 to 860 cSt. (13 to 54 cSt. recommended).

Filtration: for the inlet - 149 micron abs., for the return line - 25 micron abs. or better (with synthetic fluids: for the return line - 10 micron abs. or better).

Inlet pressure: (with mineral oil): from -0,17 to +1,4 bar (-2.5 to + 20 psi)

Operating temperature: with mineral oil -10°C +70°C (+30°C to +60°C recommended), with water based fluids +15°C to +50°C.

Drive: direct and coaxial by means of a flexible coupling.

Main operating data

max pressure / hydraulic fluid

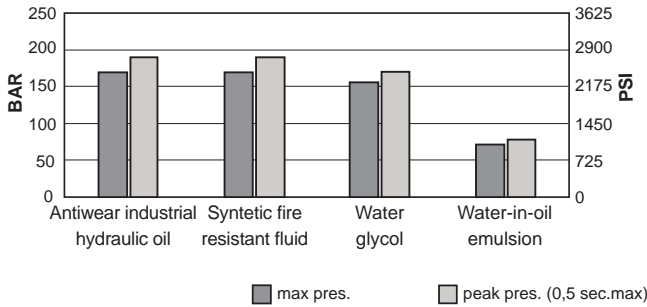

max speed / hydraulic fluid (with 0 bar in the intake pipe)

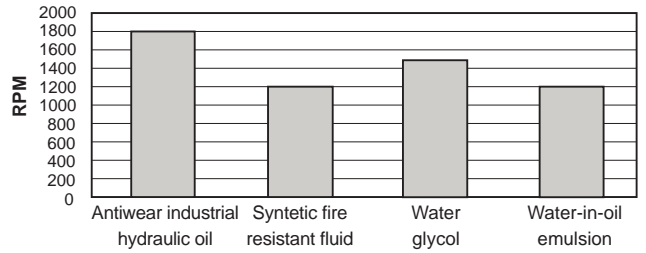

If the intake pressure is not zero bar, use the graph below to find the percentage correction factor to apply to the maximum speed

max speed / intake pipe pressure

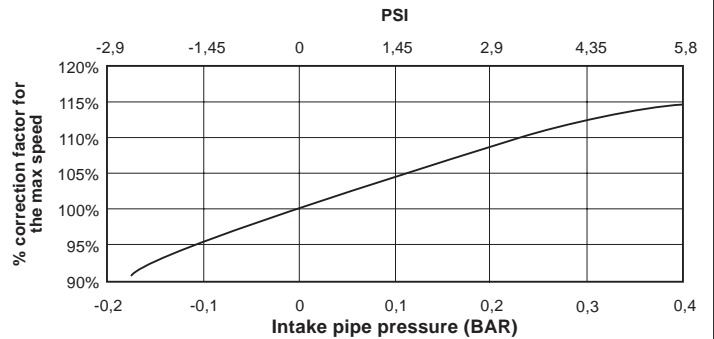

Sound level at 138 bar (2000 psi)

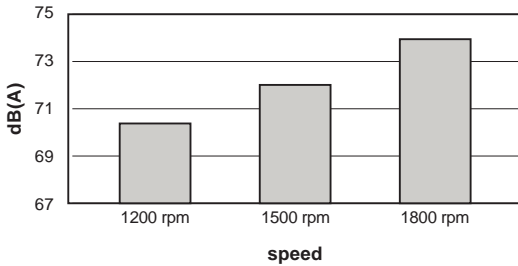

flow / pressure

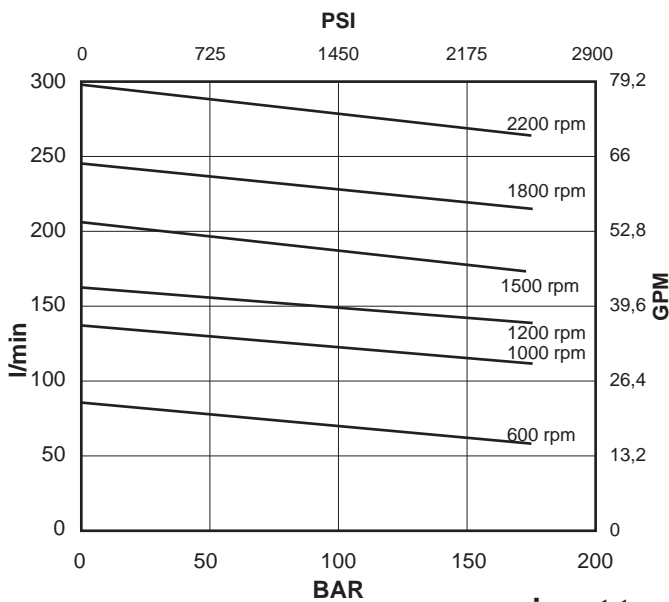

Shaft end cartridge V05-42

power / pressure

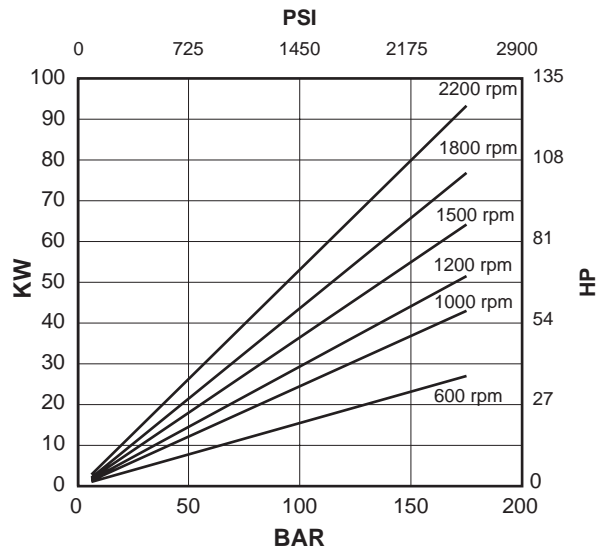

input torque / pressure

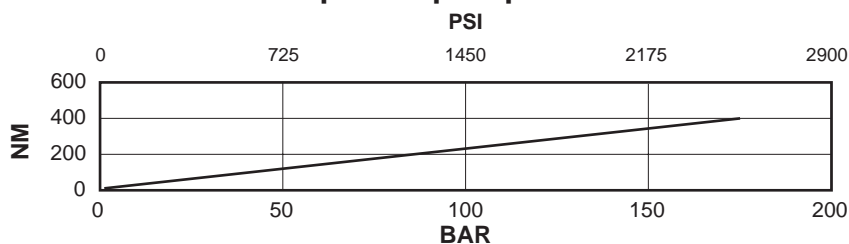

Oil viscosity: 25 c.St.(10W)
 Temperature: 45°C
 Inlet pressure: 0 BAR

Shaft end cartridge V05-47

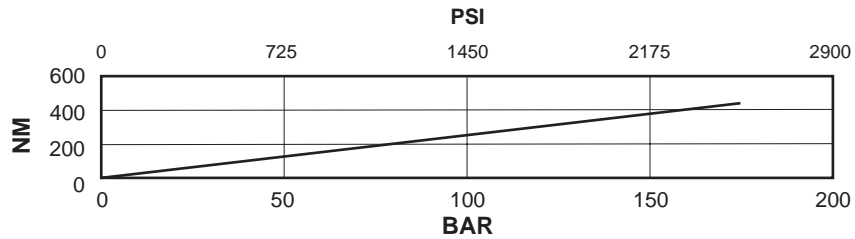
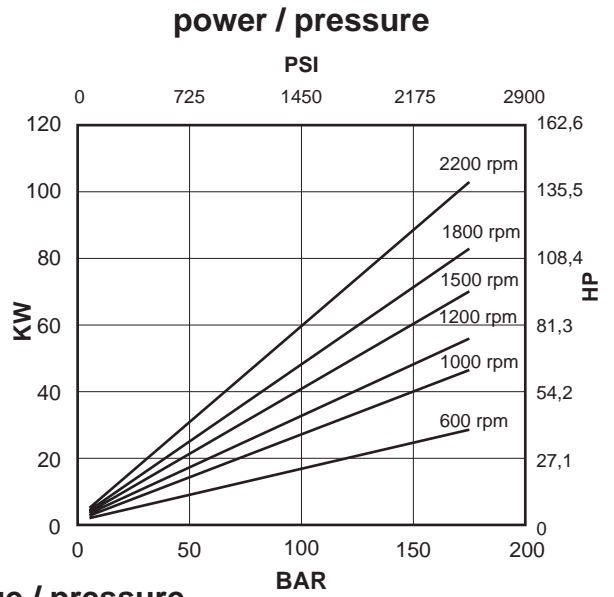
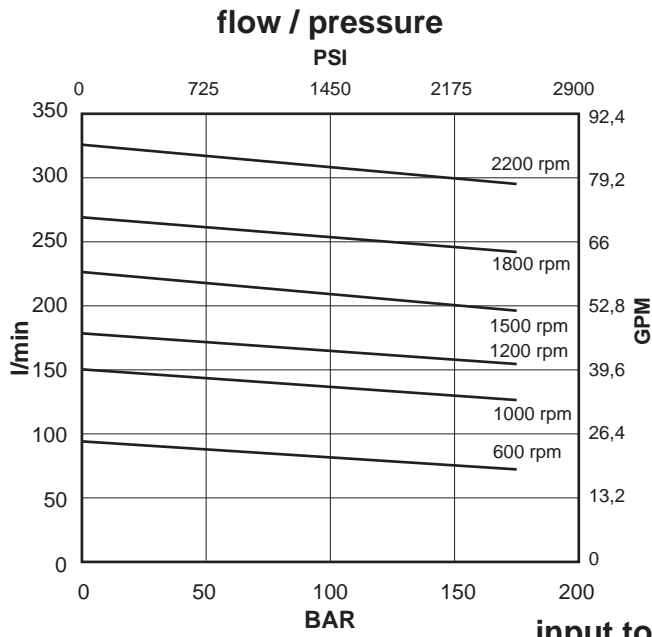

Oil viscosity: 25 c.St.(10W)
 Temperature: 45°C
 Inlet pressure: 0 BAR

Shaft end cartridge V05-50

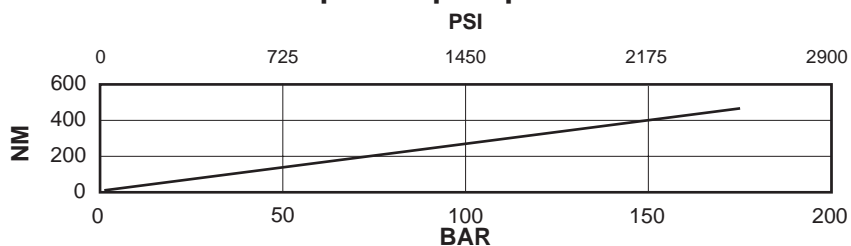
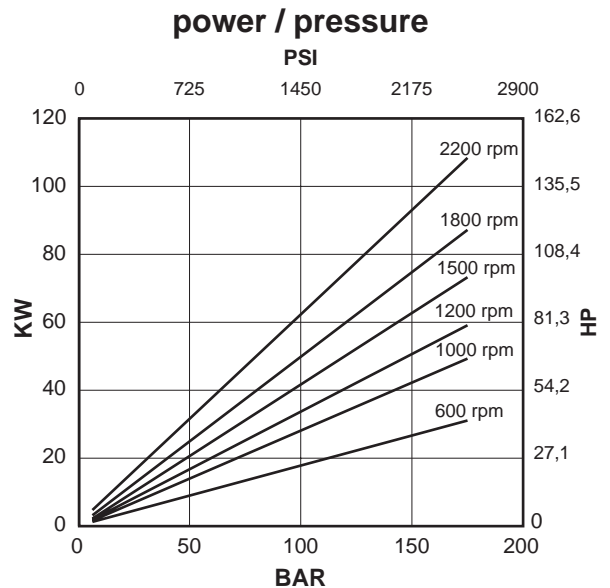
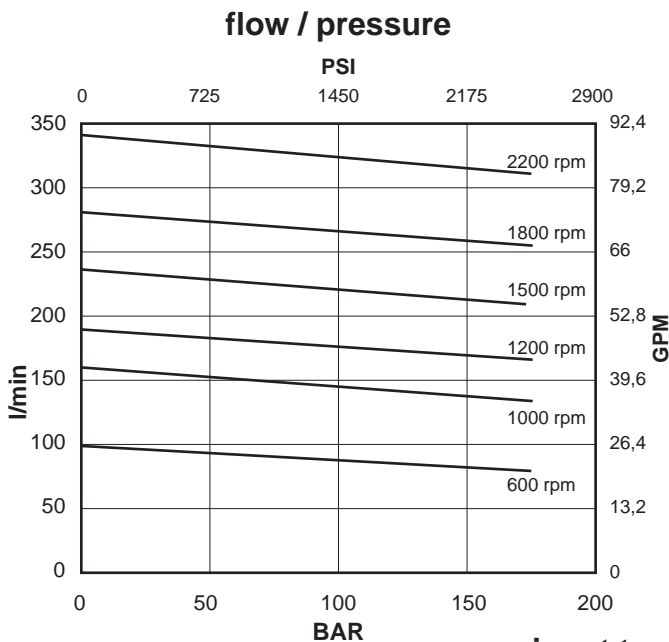

Oil viscosity: 25 c.St.(10W)
 Temperature: 45°C
 Inlet pressure: 0 BAR

Shaft end cartridge V05-57

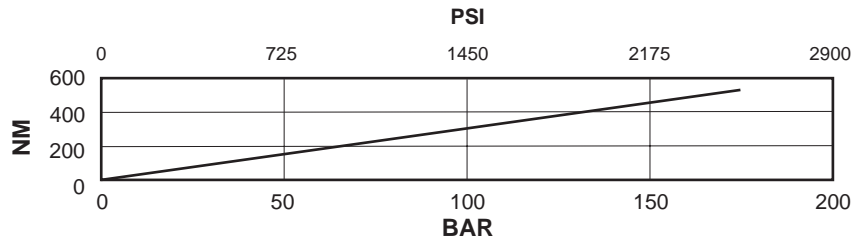
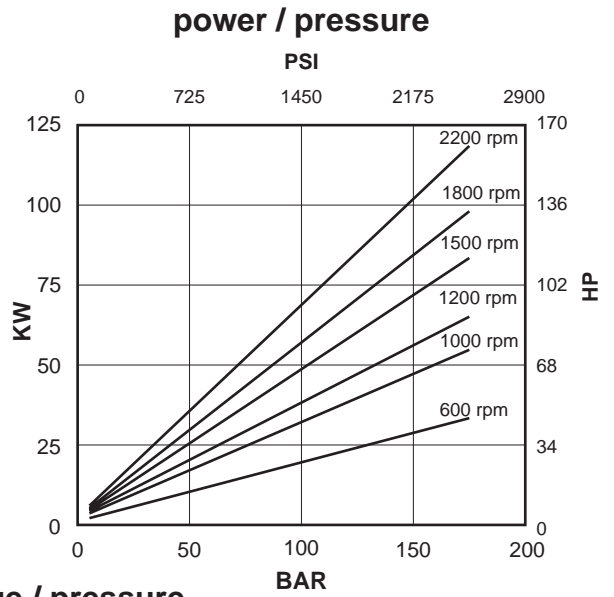
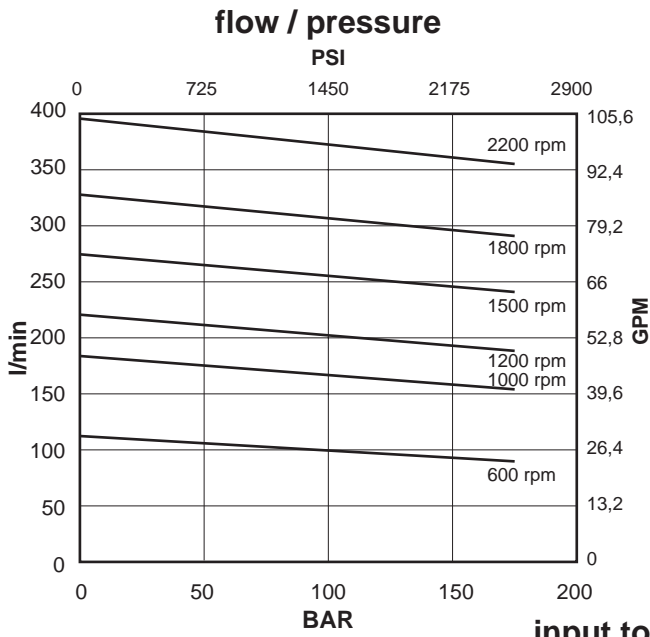

Oil viscosity: 25 c.St.(10W)
 Temperature: 45°C
 Inlet pressure: 0 BAR

Shaft end cartridge V05-60

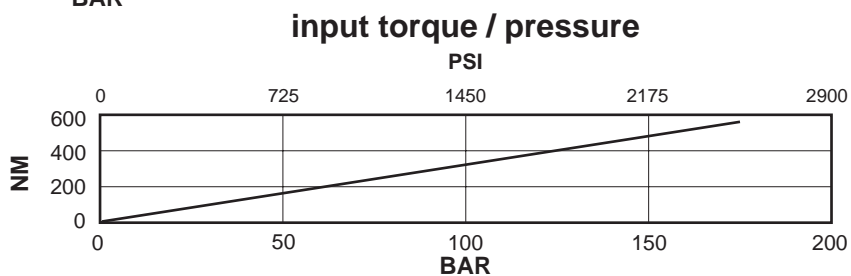
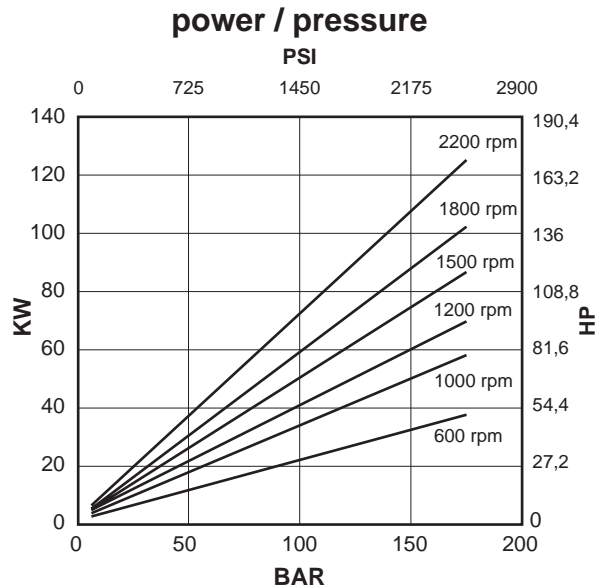
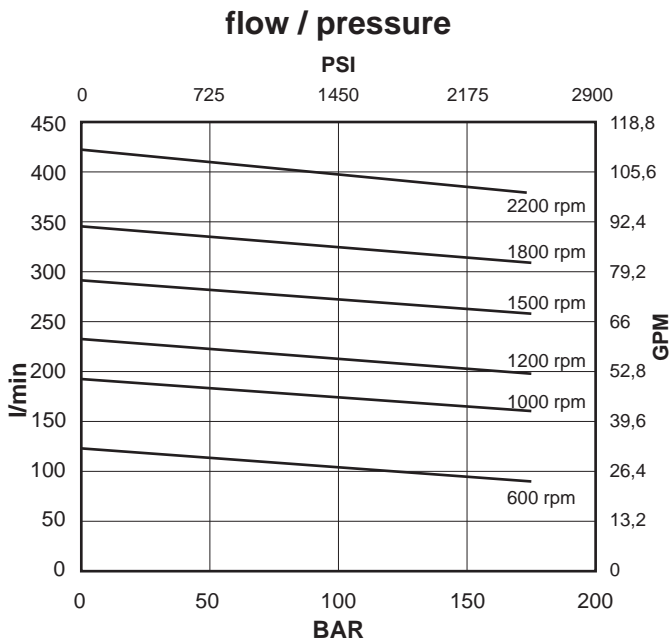

Oil viscosity: 25 c.St.(10W)
 Temperature: 45°C
 Inlet pressure: 0 BAR

Cover end cartridge V04-21

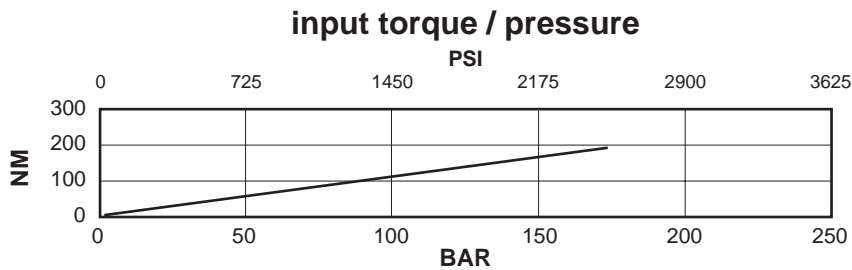
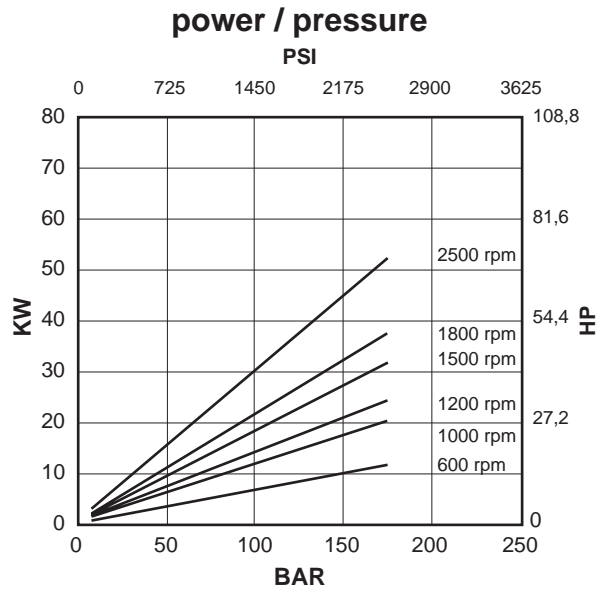
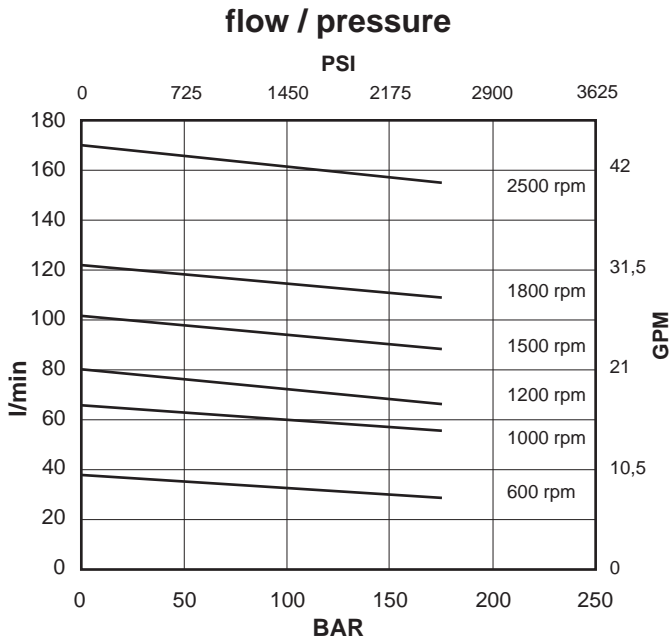

Oil viscosity: 25 c.St.(10W)
 Temperature: 45°C
 Inlet pressure: 0 BAR

Cover end cartridge V04-25

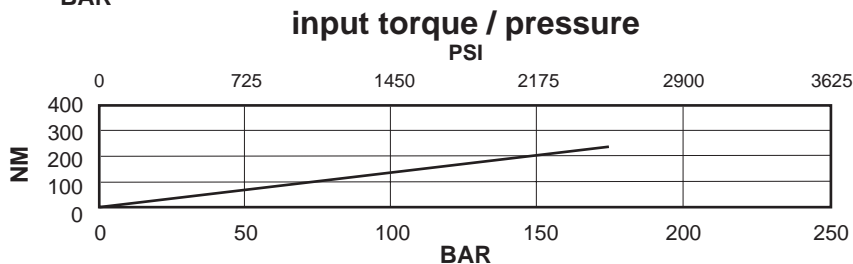
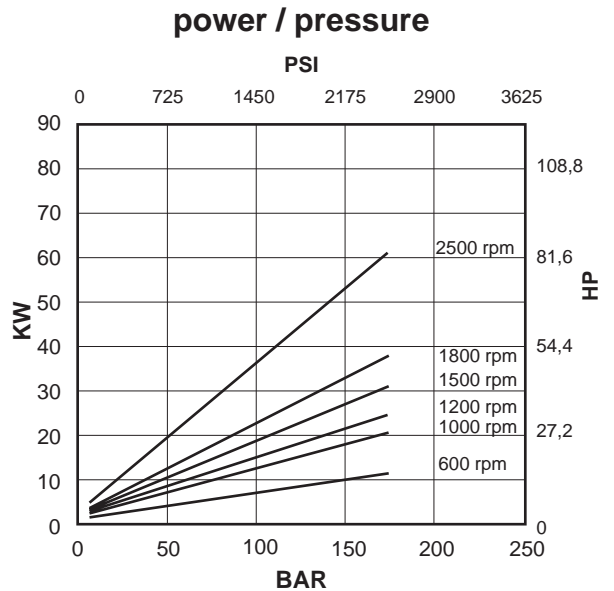
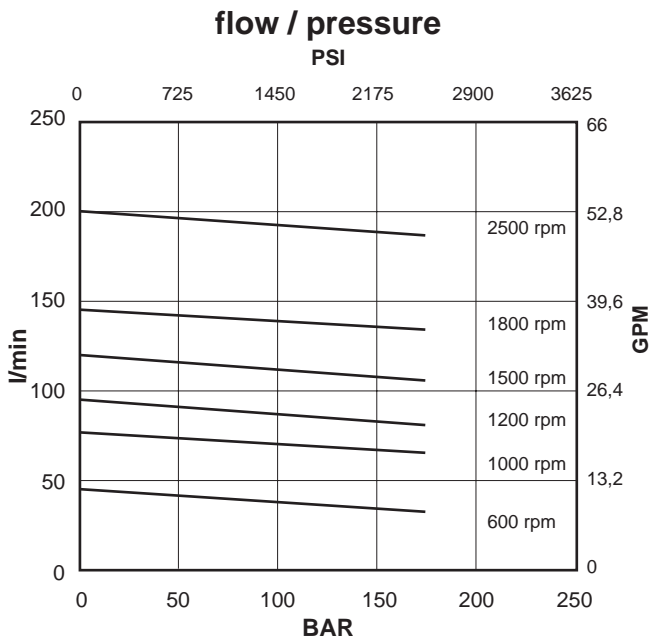

Oil viscosity: 25 c.St.(10W)
 Temperature: 45°C
 Inlet pressure: 0 BAR

Cover end cartridge V04-30

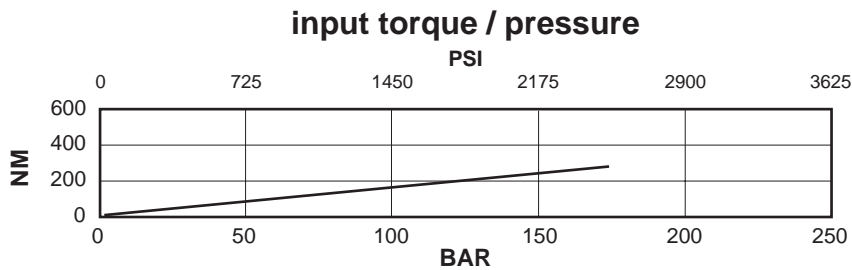
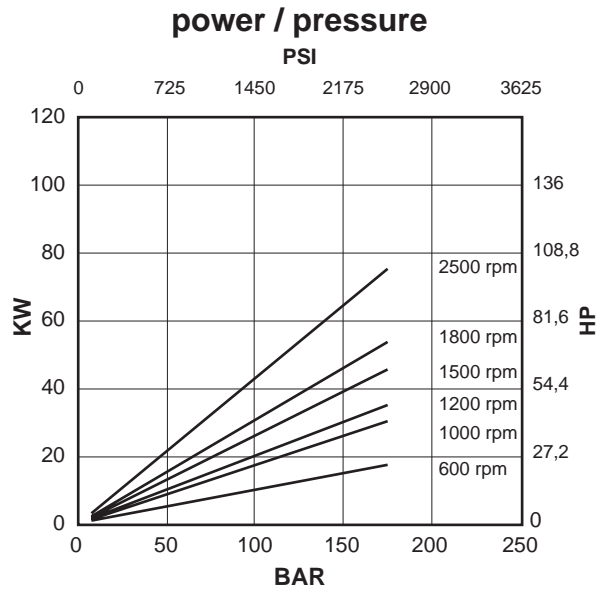
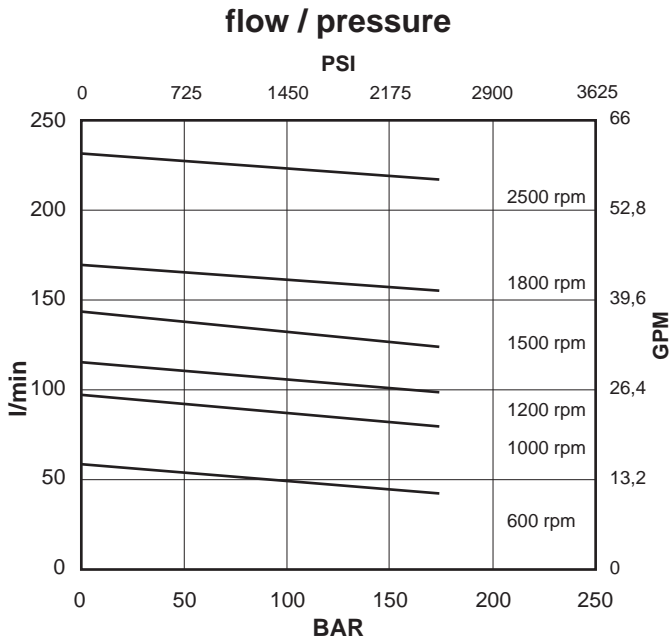

Oil viscosity: 25 c.St.(10W)
 Temperature: 45°C
 Inlet pressure: 0 BAR

Cover end cartridge V04-35

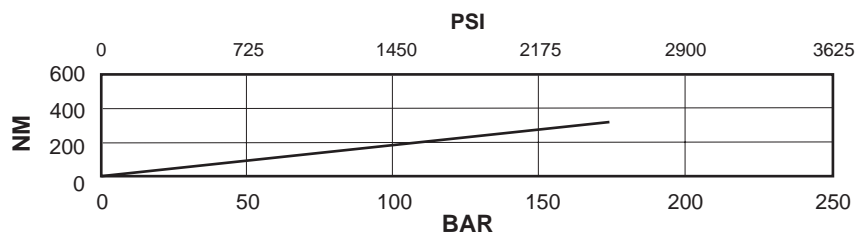
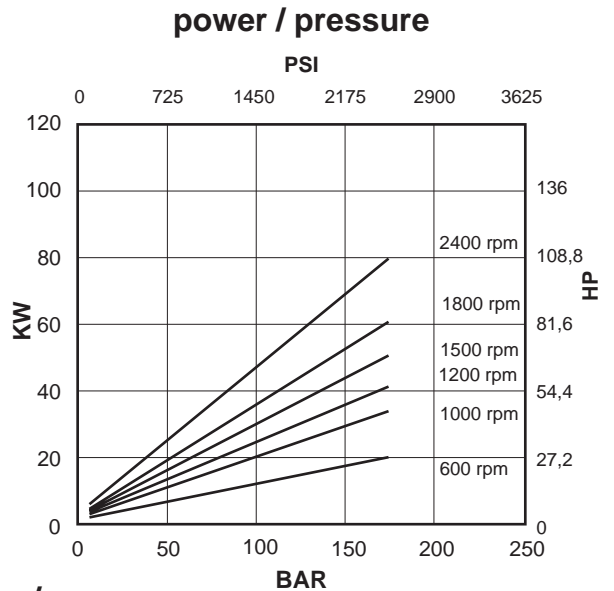
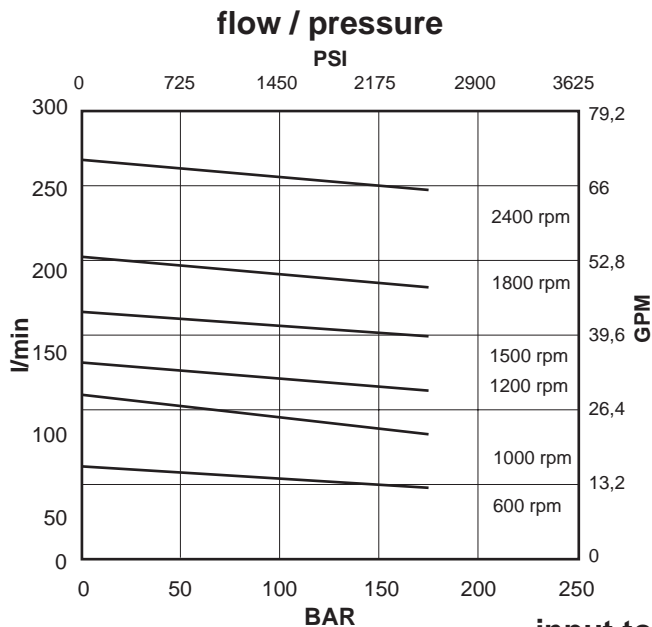

Oil viscosity: 25 c.St.(10W)
 Temperature: 45°C
 Inlet pressure: 0 BAR

Cover end cartridge V04-38

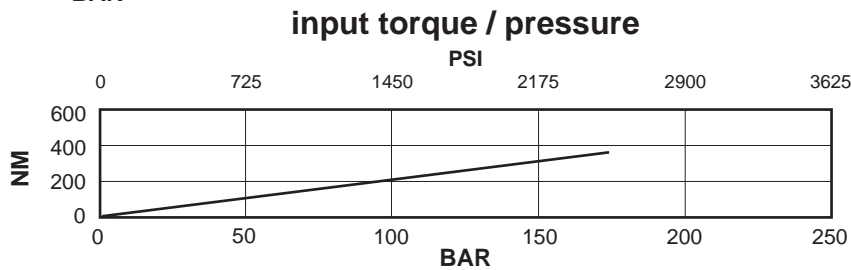
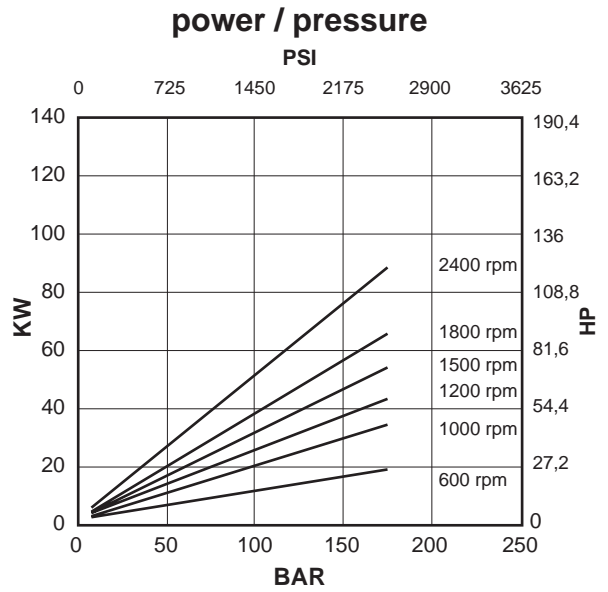
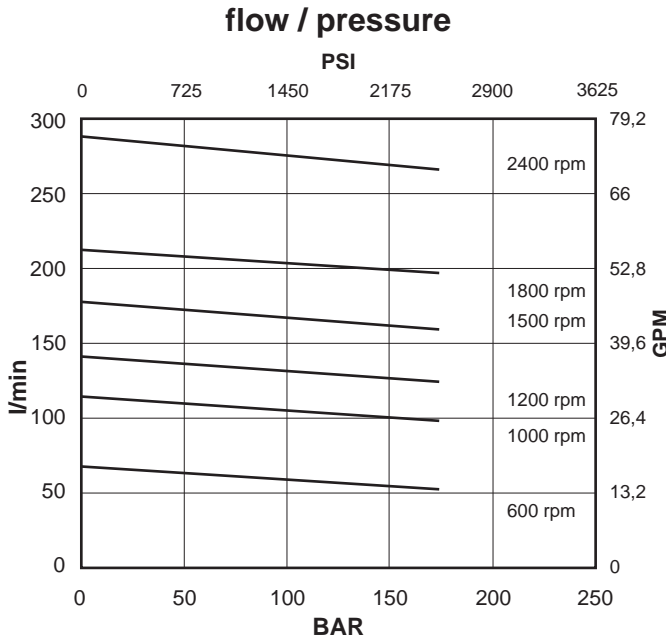

Oil viscosity: 25 c.St.(10W)
 Temperature: 45°C
 Inlet pressure: 0 BAR

Installation dimensions mm (inches)

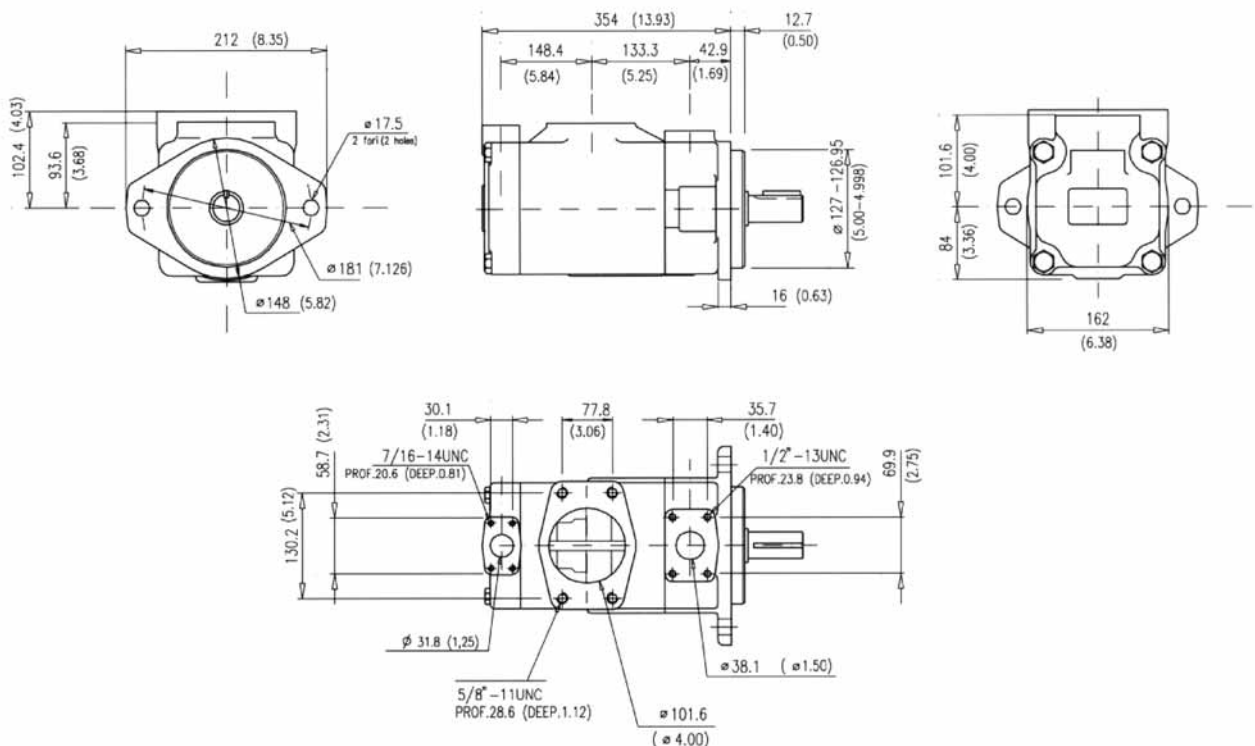

Approx. weight: 54 Kg. (118 lbs.)

Model code breakdown

BV	54	G	**	**	*	*	**	(L)	*	(A)	
Pump series		Design								Mounting (omit if not required)	
Pump type							Seals (omit with standard seals and one shaft-seal in NBR) V = seals and shaft-seal in FPM (Viton®) D = standard seals and double shaft-seals in NBR F = seals and double shaft-seals in FPM (Viton®)				
Cartridge types							Rotation (viewed from shaft end) L = left hand rotation CCW (omit if CW)				
-shaft end 42 47 50 57 60											
-cover end 21 25 30 35 38											
Body outlet port positions (outlet viewed from cover end)											
A = Outlet opposite end											
B = Outlet 90° CCW from inlet											
C = Outlet in line with inlet											
D = Outlet 90° CW from inlet											
Cover outlet port positions (outlet viewed from cover end)											
A = Outlet opposite end											
B = Outlet 90° CCW from inlet											
C = Outlet in line with inlet											
D = Outlet 90° CW from inlet											
							Shaft end options 01 = Straight with key (standard), 11 = Splined 86 = Heavy duty straight keyed, 90 = Splined SAE C				

Shaft options mm (inches)

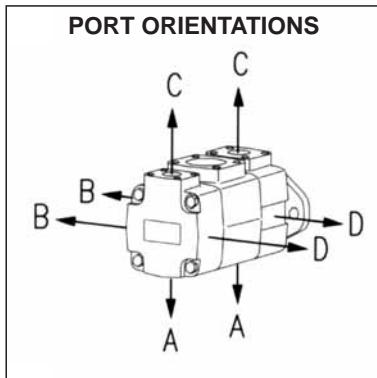
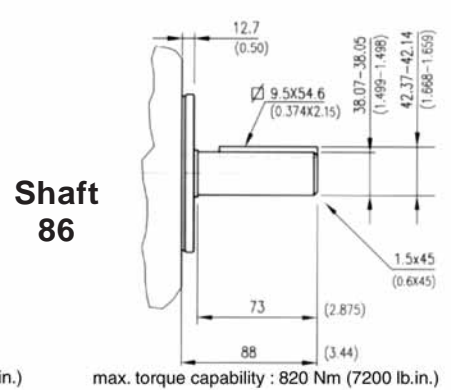
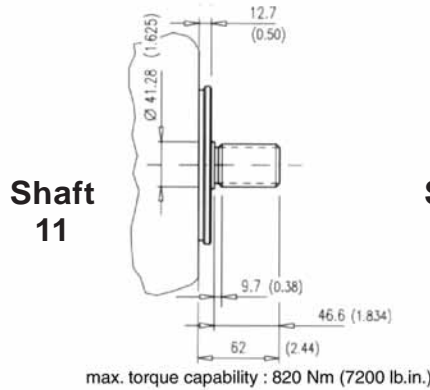
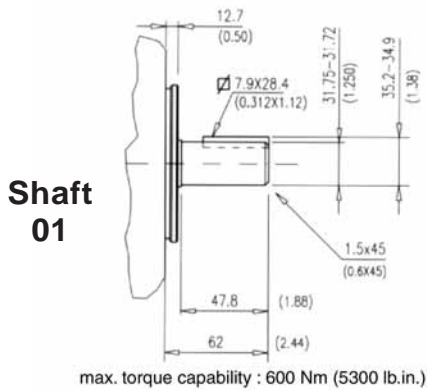

Spline data
(shaft 11 and shaft 90)
Involute side fit (ASA B5.15)

Spline		
Pressure angle	30°	
No. of teeth	14	
Pitch	12/24	
Major dia.	31.60 - 31.50	(1.244 - 1.240)
Pitch dia.	29.634	(1.1667)
Minor dia.	26.99 - 26.66	(1.0627 - 1.05)
Wildhaber	15.68 - 15.73	(0.617 - 0.619)

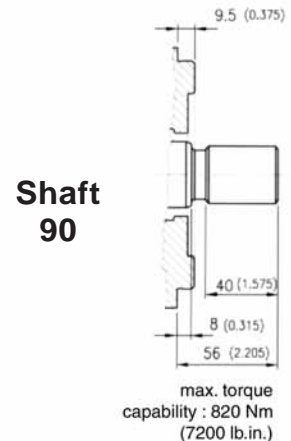

Cartridges						
Series	cover end		shaft end		Pump rotation	
	Model	Part No.	Series	Model		Part No.
V04	21	V0421010	V05	42	V0542010	right hand
	25	V0425050		47	V0547030	
	30	V0430090		50	V0550050	
	35	V0435130		57	V0557070	
V04	38	V0438170	V05	60	V0560090	left hand
	21	V0421020		42	V0542020	
	25	V0425060		47	V0547040	
	30	V0430100		50	V0550060	
V04	35	V0435140	V05	57	V0557080	left hand
	38	V0438180		60	V0560100	

Shaft kit	
Model	Part No.
01	M8540601
11	M8540611
86	M8540686
90	M8540690

Shaft	
Model	Part No.
01	K5401000
11	K5411000
86	K5486000
90	K5490000

Body	
Part No.	M8050250

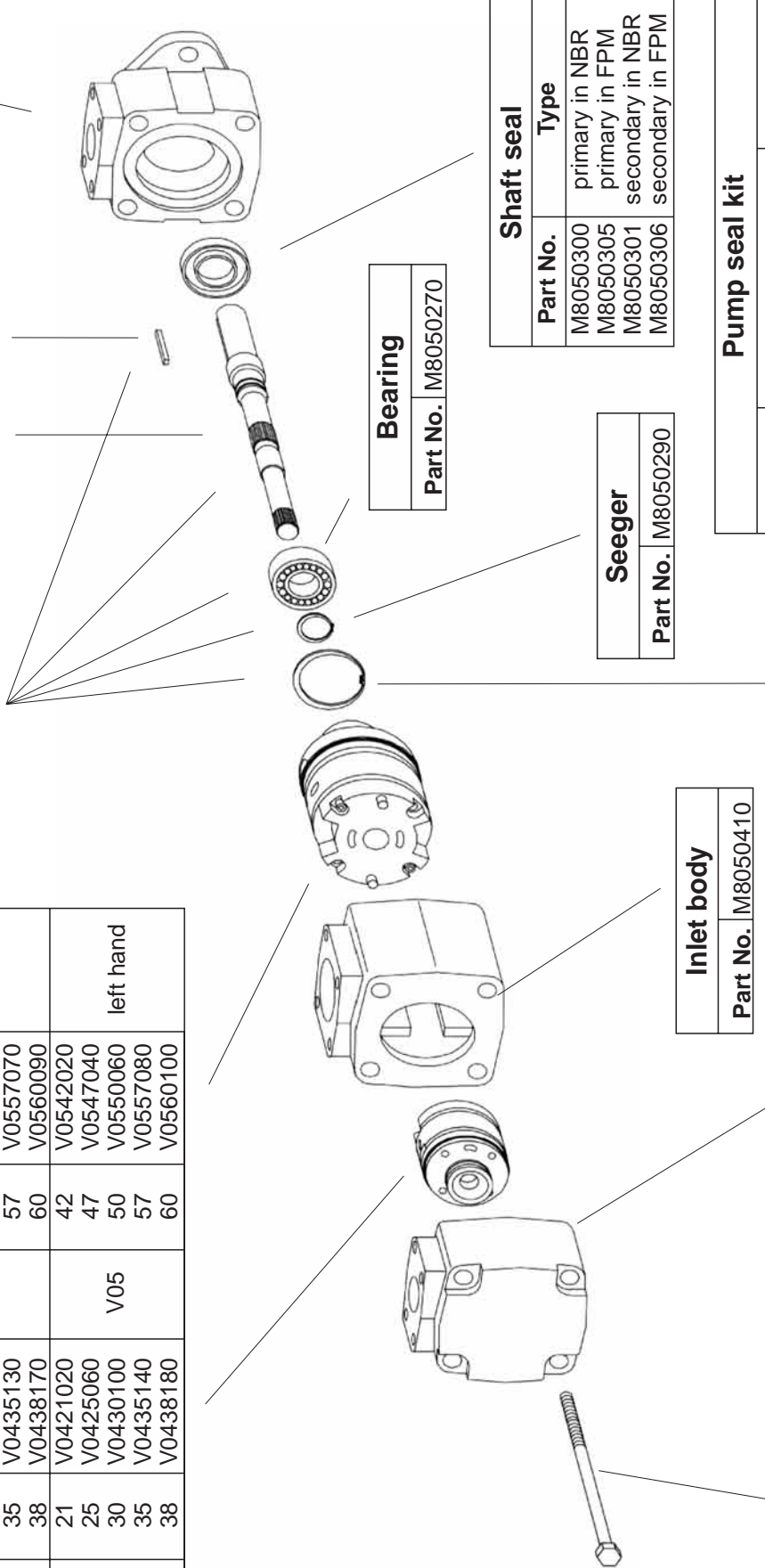

Screw	
Part No.	M8050380
Torque to 398 Nm (3550 lb. in.)	

Cover	
Part No.	M8050360

Seeger	
Part No.	M8050280

Inlet body	
Part No.	M8050410

Seeger	
Part No.	M8050290

Shaft seal	
Part No.	Type
M8050300	primary in NBR
M8050305	primary in FPM
M8050301	secondary in NBR
M8050306	secondary in FPM

Pump seal kit		
Part No.	Parts	Type
M8540500	seals + 1 shaft seal	NBR
M8540501	seals + 2 shaft seals	NBR
M8540503	seals + 1 shaft seal	FPM (Viton®)
M8540504	seals + 2 shaft seals	FPM (Viton®)

Id. codes of cartridge kit components

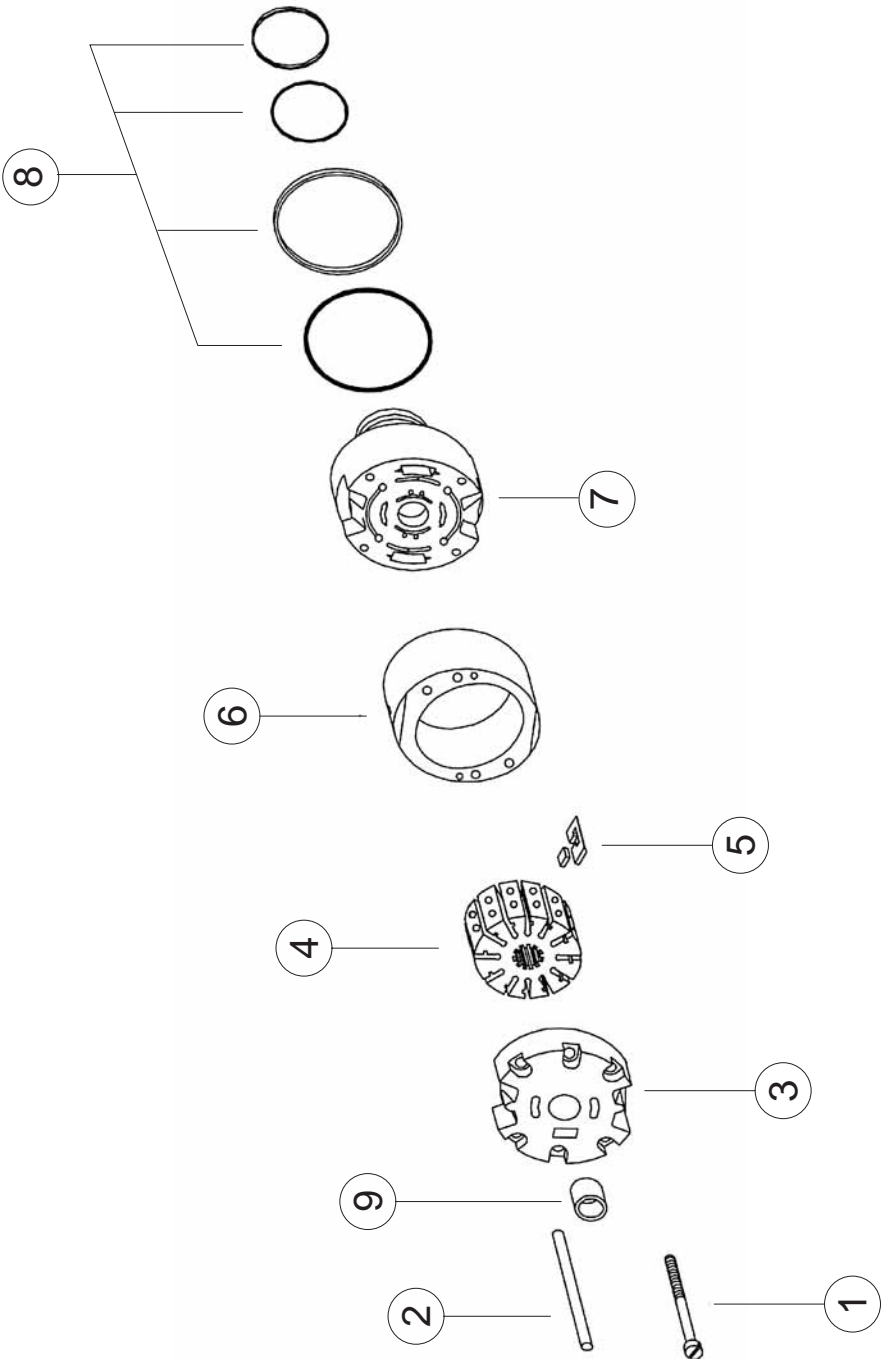

Cartridge Series Model	1 Screw	2 Pin	3 Inlet support plate	4 Rotor	5 Vane and insert kit (12+12 pcs.)	6 Ring	7 Outlet support plate	8 Seal kit (4 pcs.)	9 Bushing (*)
V01	02		L6209200	L6209300	L6209100	L7209002			
	05		L6209200	L6209300	L6209100	L7209005			
	08		L6209200	L6209300	L6209100	L7209008			
	09		L6209200	L6209300	L6209100	L7209009	L6200100	L6201100 L6202100 (FPM)	L6200600
	11	L6200900	L6200200	L6200300	L6201200	L7201011			
	12	3,6 Nm (32 lb. in.)	L6200200	L6200300	L6201200	L7201012			
	14		L6200200	L6200300	L6201200	L7201014			
	12					L6251012			
V02	14					L6251014			
	17	L6250900	L6250200	L6250300	L6251200	L6251017	L6250100	L6251100 L6252100 (FPM)	L7250600
	19	5,5 Nm (49 lb. in.)				L6251019			
	21					L6251021			
V04	21					L6351021			
	25					L6351025			
	30	L6350900	L6350800	L6350200	L6351200	L6351030	L6350100	L6351100 L6352100 (FPM)	L7350600
	35	12,6 Nm (112 lb.in)				L6351035			
V05	38					L6351038			
	42					L6451042			
	47					L6451047			
	50	L6450900	L6450800	L6450200	L6451200	L6451050	L6450100	L6451100 L6452100 (FPM)	L7450600
	57	12,6 Nm (112 lb.in)				L6451057			
	60					L6451060			

(*) Note: The cover end cartridge of the double pump is without bushing.

Operating instructions

Maximum speed: the maximum speeds given in this catalogue are valid for an atmospheric pressure of 1 bar (14.7 psi) and with ambient temperature in the range of +30°C to +50°C. Higher speeds than those given cause a reduction in the volumetric efficiency, due to cavitation phenomena in the inlet area inside the pump. Sustained excess speed causes a rapid deterioration of the internal components reducing the lifetime of the cartridge.

Minimum speed: In general, the min. speed for all pumps is 600 rpm. However, it is possible to operate at lower speeds with certain pump configurations and with appropriate operating temperatures.

Inlet pressure: the inlet pressure, measured at the inlet port, should remain within the prescribed limits. Note that pressures lower than minimum limit cause cavitation and pressures above the maximum limit cause abnormal loads on the shaft and the bearings. In both cases this causes a significant reduction in the lifetime of the cartridge.

Maximum outlet pressure: the maximum outlet pressure is different for each type of fluid used as can be seen from the corresponding diagrams. With optimal temperature and filtration conditions a pressure peak of +10% is permissible for a maximum time of 0.5 sec.

Mounting and drive connections: consider the following indications when preparing the installation drawings for the system:

- the pump is designed to operate with keyed shaft coupled axially and by means of a flexible coupling to the drive;
- the clearance between the keyed shaft and the corresponding sleeve coupling has to be between 0.004 and 0.030 mm;
- avoid axial and radial loads on the shaft;
- the mounting flange has to be perpendicular to the drive shaft, with a maximum error of 0.18 mm every 100 mm;
- when mounting onto a gearbox, or other component without a flexible coupling, it is advisable to order pumps with splined shaft. In this case the clearance between splines has to be between 0.013 and 0.051 mm on the pitch diameter.

Hydraulic circuit: always install a pressure relief valve on the supply line to prevent the pressure from exceeding the allowed maximum. Normally, it is set in accordance with the weakest component in the system. (In the case where it is the pump, set the valve to a pressure 15% higher than the maximum pressure rating of the pump.) Inlet line tubing should have a section equal to or greater than that of the inlet port of the pump. It is advisable to keep the tube connecting the pump to the reservoir as short possible. Particular care has to be taken with the inlet line which has to be hermetically sealed to avoid entraining air into the circuit; this varies the characteristics of the hydraulic fluid causing the operating parts to become damaged.

Filtration: the inlet line filter must have a flow rate capacity that is higher than that of the pump at its maximum operating speed. The filtration requirements for individual models are given in this catalogue. The use of a filter by-pass is recommended for cold starts and should the filter become clogged. Proper maintenance of the filter element is essential for the correct operation of the entire system. In normal conditions replace the filter element after the first 50 hours of operation. Subsequently, replace it at least every 500 hours. Regarding the filter on the return line, the same general conditions apply as for the inlet line and it should be positioned in an accessible location for ease of maintenance.

Tank: if possible, the reservoir should be positioned above the pump. Otherwise, ensure that the minimum level of the fluid contained in it is higher than the pump inlet line opening. It is important to avoid draining the inlet line with the pump at standstill. The opening of the return line into the reservoir must remain below the minimum level of the fluid in the reservoir. It must not be positioned too close to the opening of the inlet line to avoid the possibility of any air bubbles passing into the inlet line. Baffles inside the reservoir may be useful in avoiding the problem. Rapid temperature changes can cause condensation on the underside of the lid of the reservoir with the formation of droplets of water that can fall into the oil. To avoid this problem it is recommended that the lid should have small vents so that the air space in the reservoir is ventilated. The vents have to be screened, though, to prevent the entry of dust or the sudden expulsion of fluid.

Start-up: use the following procedure when the pump is started-up for the first time:

- completely fill the pump and the inlet line with fluid;
 - start the engine for approximately one second a number of times at regular intervals of approximately 2 or 3 seconds until the noise level reduces, thereby confirming that it has been primed;
 - with a manometer check to ensure that the outlet pressure increases slightly;
 - once the pump has been primed, maintain low pressure levels activating all parts of the circuit a number of times until air bubbles disappear completely from the return line to the reservoir.
- This procedure should be carefully as any residual air inside the pump can quickly cause the rotor to seize.

Cold starting: when starting the pump, especially with low ambient temperatures, operate with moderate speed and pressure until the average temperature in the entire circuit is within the given limits.

The information provided in this catalogue is subject to change without notice